

**ASYMMETRICAL-BIDIRECTIONAL THYRISTOR
OVERVOLTAGE PROTECTOR**

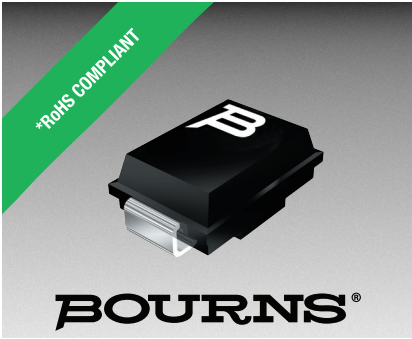

TISP4A250H3BJ Overvoltage Protector

RING Line Protection for:
-LCAS (Line Card Access Switch)
such as Le75181, Le75183 and Le75282

Voltages Optimized for:
-Battery-Backed Ringing Circuits
Maximum Ringing a.c 104 Vrms
Maximum Battery Voltage -52 V

| Device Name | V _{DRM} V | V _(BO) V |
|---------------|-----------------------|------------------------|
| TISP4A250H3BJ | +100 | +125 |
| | -200 | -250 |

**Rated for International Surge Wave
Shapes**

| Wave Shape | Standard | I _{PPSM} A |
|------------|------------------|------------------------|
| 2/10 μs | GR-1089-CORE | 500 |
| 8/20 μs | IEC 61000-4-5 | 300 |
| 10/160 μs | TIA-968-A | 250 |
| 10/700 μs | ITU-T K.20/21/45 | 200 |
| 10/560 μs | TIA-968-A | 160 |
| 10/1000 μs | GR-1089-CORE | 100 |

SMB Package (Top View)

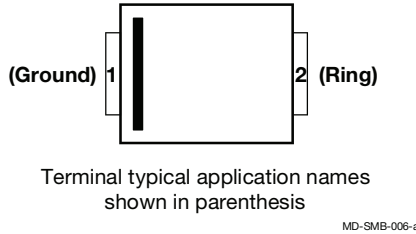

Device Symbol

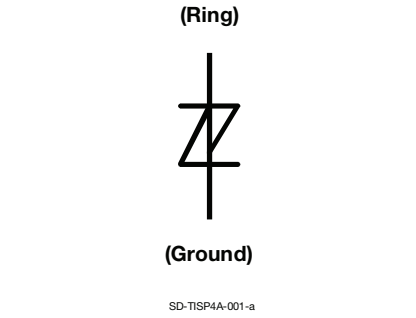

Additional Information

Click these links for more information:

[PRODUCT SELECTOR](#)
[TECHNICAL LIBRARY](#)
[INVENTORY](#)
[SAMPLES](#)
[CONTACT](#)

Agency Recognition

| Description | |
|-------------|--------------------------------------|
| UL | File Number: E215609 |

..... UL Recognized Component

Description

The TISP4A250H3BJ is an asymmetrical bidirectional overvoltage protector. It is designed to limit the peak voltages on the Ring line terminal of the LCAS (Line Card Access Switch) such as Le75181, Le75183 and Le75282. The TISP4A250H3BJ must be connected with bar-indexed terminal 1 to the protective Ground, and terminal 2 to the Ring conductor.

The TISP4A250H3BJ voltages are chosen to give adequate LCAS ring line terminal protection for all switch conditions. The most potentially stressful condition is low level power cross when the LCAS switches are closed. Under this condition, the TISP4A250H3BJ limits the voltage and corresponding LCAS dissipation until the LCAS thermal trip operates and opens the switches.

Under open-circuit ringing conditions, the line Ring conductor will have high peak voltages. For battery backed ringing, the Ring conductor will have a larger peak negative voltage than positive, i.e. the peak voltages are asymmetric. The TISP4A250H3BJ has a similar voltage asymmetry and will allow the maximum possible ringing voltage, while giving the most effective protection. On a connected line, the Tip conductor will have much smaller voltage levels than the open-circuit Ring conductor values. Here a TISP4xxxH3BJ series symmetrical voltage protector gives adequate protection.

Overvoltages are initially clipped by breakdown clamping. If sufficient current is available from the overvoltage, the breakdown voltage will rise to the breakover level, which causes the device to switch into a low-voltage on-state condition. This switching action removes the high voltage stress from the following circuitry and causes the current resulting from the overvoltage to be safely diverted through the protector. The high holding (switch off) current helps prevent d.c. latchup as the diverted current subsides.

WARNING Cancer and Reproductive Harm
www.P65Warnings.ca.gov

TISP4A250H3BJ Overvoltage Protector

BOURNS®

How to Order

| Device | Package | Carrier | Order As | Marking Code | Standard Quantity |
|---------------|---------|----------------------|------------------|--------------|-------------------|
| TISP4A250H3BJ | SMB | Embossed Tape Reeled | TISP4A250H3BJR-S | 4A250H | 3000 |

Absolute Maximum Ratings, $T_A = 25\text{ }^\circ\text{C}$ (Unless Otherwise Noted)

| Rating | Symbol | Value | Unit |
|---|------------|---|------------------|
| Repetitive peak off-state voltage (see Note 1) | V_{DRM} | +100 -200 | V |
| Non-repetitive peak impulse current (see Notes 2 and 3) 2/10 μs (GR-1089-CORE, 2/10 μs voltage wave shape) 8/20 μs (IEC 61000-4-5, 1.2/50 μs voltage, 8/20 μs current combination wave generator) 10/160 μs (TIA-968-A, 10/160 μs voltage wave shape) 5/310 μs (ITU-T K.44, 10/700 μs voltage wave shape used in K.20/21/45) 5/320 μs (TIA-968-A, 9/720 μs voltage wave shape) 10/560 μs (TIA-968-A, 10/560 μs voltage wave shape) 10/1000 μs (GR-1089-CORE, 10/1000 μs voltage wave shape) | I_{PPSM} | ± 500 ± 300 ± 250 ± 200 ± 200 ± 160 ± 100 | A |
| Non-repetitive peak on-state current (see Notes 2, 3 and 4) 20 ms, 50 Hz (full sine wave) 16.7 ms, 60 Hz (full sine wave) 1000 s, 50 Hz or 60 Hz a.c. | I_{TSM} | 55 60 2.2 | A |
| Initial rate of rise of on-state current, exponential current ramp. Maximum ramp value < 200 A | di_T/dt | 400 | A/ μs |
| Junction temperature | T_J | -40 to +150 | $^\circ\text{C}$ |
| Storage temperature range | T_{stg} | -65 to +150 | $^\circ\text{C}$ |

- NOTES: 1. See Figure 6 for voltages at other temperatures.
2. Initially the device must be in thermal equilibrium with $T_J = 25\text{ }^\circ\text{C}$.
3. The surge may be repeated after the device returns to its initial conditions.
4. EIA/JESD51-2 environment and EIA/JESD51-3 PCB with standard footprint dimensions connected with 5 A rated printed wiring track widths. See Figure 5 for the current ratings at other durations. Derate current values at $-0.61\text{ }^\circ\text{C}$ for ambient temperatures above $25\text{ }^\circ\text{C}$.

Overload Ratings, $T_A = 25\text{ }^\circ\text{C}$ (Unless Otherwise Noted)

| Rating | Symbol | Value | Unit |
|--|--------------|---------------------------|-------|
| Maximum overload on-state current without open circuit, 50 Hz or 60 Hz a.c. (see note 5) 0.03 s 0.07 s 1.6 s 5.0 s 1000 s | $I_{T(OV)M}$ | 60 40 8 7 2.2 | A rms |

- NOTE: 5. Peak overload on-state current during a.c. power cross tests of GR-1089-CORE and UL 1950/60950. These electrical stress levels may damage the TISP4A250H3BJ silicon die. After test, the pass criterion is either that the device is functional or, if it is faulty, that it has a short-circuit fault mode. In the short-circuit fault mode, the following equipment is protected as the device is a permanent short across the line. The equipment would be unprotected if an open-circuit fault mode developed.

NOVEMBER 2006 – REVISED APRIL 2023

Specifications are subject to change without notice.

Users should verify actual device performance in their specific applications.

The products described herein and this document are subject to specific legal disclaimers as set forth on the last page of this document, and at www.bourns.com/docs/legal/disclaimer.pdf.

TISP4A250H3BJ Overvoltage Protector

BOURNS®

Electrical Characteristics, $T_A = 25\text{ °C}$ (Unless Otherwise Noted)

| Parameter | Test Conditions | Min | Typ | Max | Unit |
|--|---|-----------|-----|---------------------|-------------------|
| I_{DRM} Repetitive peak off-state current | $V_D = V_{DRM}$ $T_A = 25\text{ °C}$ $T_A = 85\text{ °C}$ | | | ± 5 ± 10 | μA |
| $V_{(BO)}$ Breakover voltage | $dv/dt = \pm 250\text{ V/ms}$, $R_{SOURCE} = 300\ \Omega$ | | | +125 -250 | V |
| $I_{(BO)}$ Breakover current | $dv/dt = \pm 250\text{ V/ms}$, $R_{SOURCE} = 300\ \Omega$ | ± 150 | | ± 600 | mA |
| V_T On-state voltage | $I_T = \pm 5\text{ A}$, $t_w = 100\ \mu\text{s}$ | | | ± 3 | V |
| I_H Holding current | $I_T = \pm 5\text{ A}$, $di/dt = \pm 30\text{ mA/ms}$ | ± 150 | | ± 600 | mA |
| dv/dt Critical rate of rise of off-state voltage | Linear voltage ramp Maximum ramp value $< 0.85V_{DRM}$ | ± 5 | | | kV/ μs |
| C_O Off-state capacitance | $f = 1\text{ MHz}$, $V_d = 1\text{ V rms}$ $V_D = 2\text{ V}$ | | | 72 | pF |

Thermal Characteristics

| Parameter | Test Conditions | Min | Typ | Max | Unit |
|--|--|-----|-----|-----|----------------------|
| $R_{\theta JA}$ Junction to ambient thermal resistance | EIA/JESD51-3 PCB, $I_T = I_{TSM(1000)}$ (see Note 6) | | | 113 | $^{\circ}\text{C/W}$ |
| | 265 mm x 210 mm populated line card, 4-layer PCB, $I_T = I_{TSM(1000)}$ | | 50 | | |

NOTE: 6. EIA/JESD51-2 environment and PCB has standard footprint dimensions connected with 5 A rated printed wiring track widths.

NOVEMBER 2006 – REVISED APRIL 2023

Specifications are subject to change without notice.

Users should verify actual device performance in their specific applications.

The products described herein and this document are subject to specific legal disclaimers as set forth on the last page of this document, and at www.bourns.com/docs/legal/disclaimer.pdf.

Parameter Measurement Information

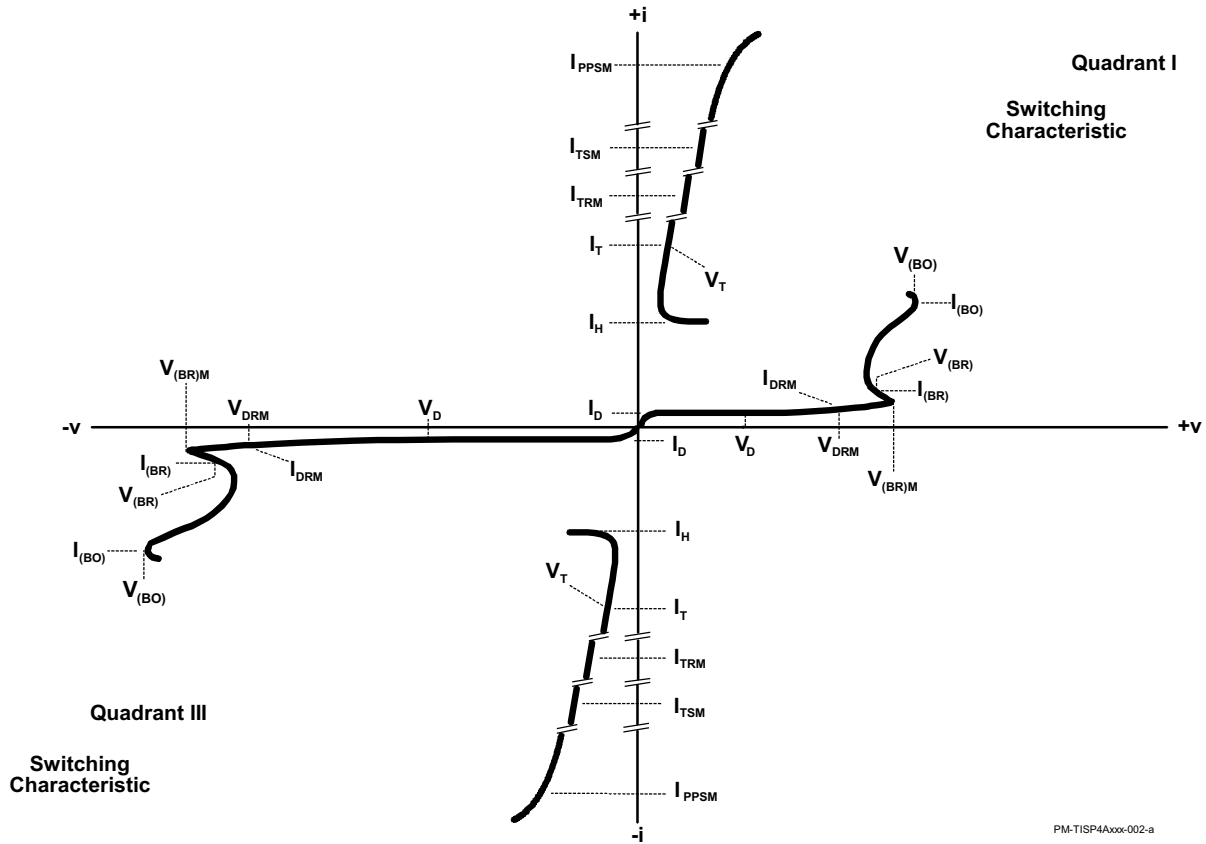

PM-TISP4Axxx-002-a

**Figure 1. Voltage-Current Characteristic for the Ring and Ground Terminals
All Measurements are Referenced to the Ground Terminal**

Typical Characteristics

**OFF-STATE CURRENT
vs
JUNCTION TEMPERATURE**

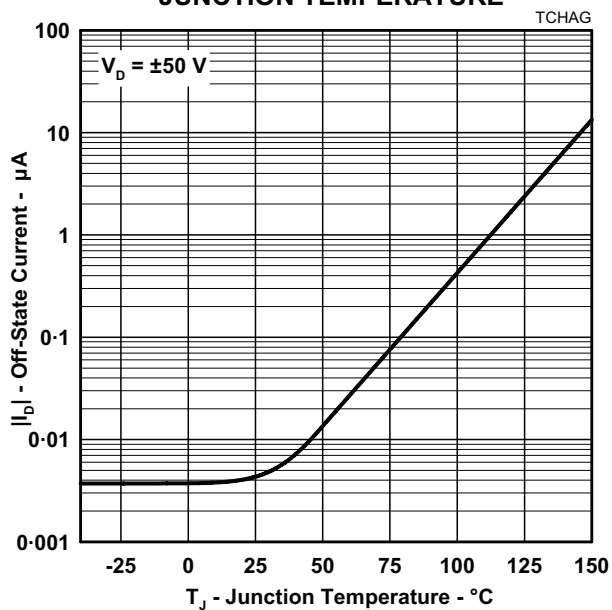

Figure 2.

**NORMALIZED BREAKOVER VOLTAGE
vs
JUNCTION TEMPERATURE**

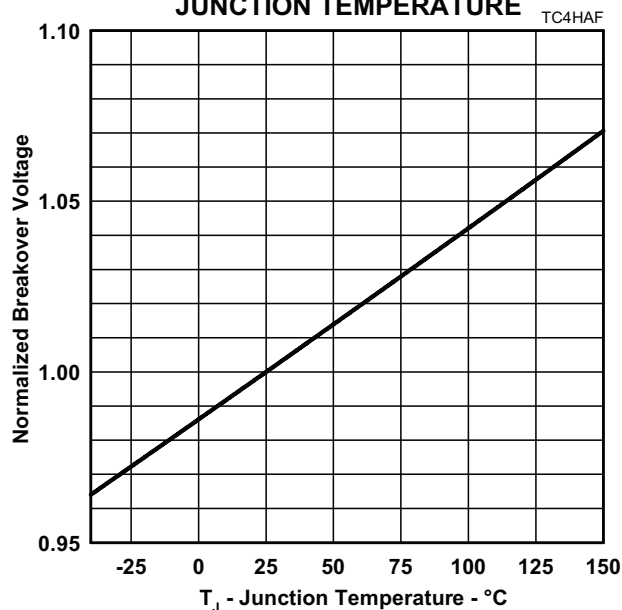

Figure 3.

**NORMALIZED HOLDING CURRENT
vs
JUNCTION TEMPERATURE**

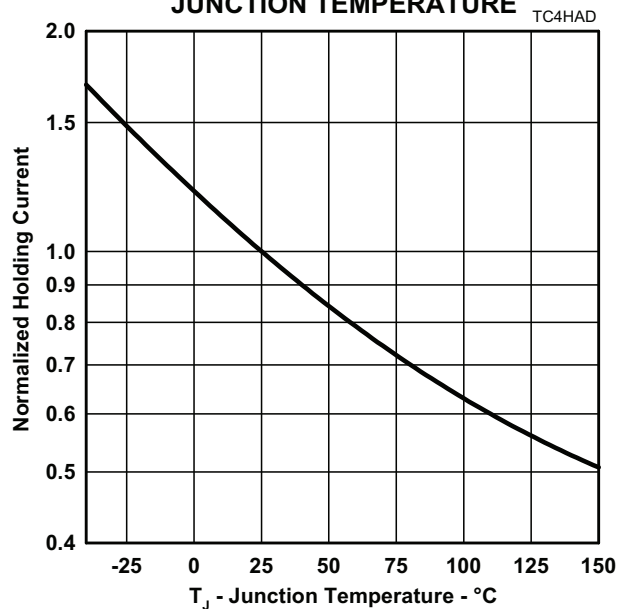

Figure 4.

NOVEMBER 2006 – REVISED APRIL 2023

Specifications are subject to change without notice.

Users should verify actual device performance in their specific applications.

The products described herein and this document are subject to specific legal disclaimers as set forth on the last page of this document, and at www.bourns.com/docs/legal/disclaimer.pdf.

Rating and Thermal Information

NON-REPETITIVE PEAK ON-STATE CURRENT VS CURRENT DURATION

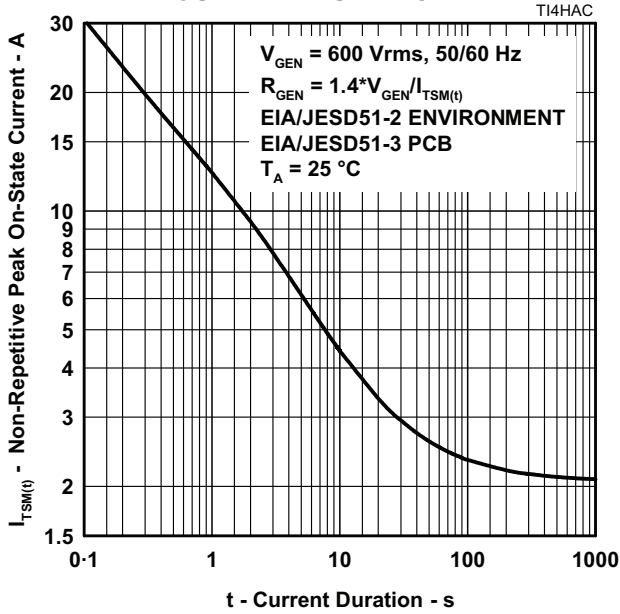

Figure 5.

V_{DRM} DERATING FACTOR VS MINIMUM AMBIENT TEMPERATURE

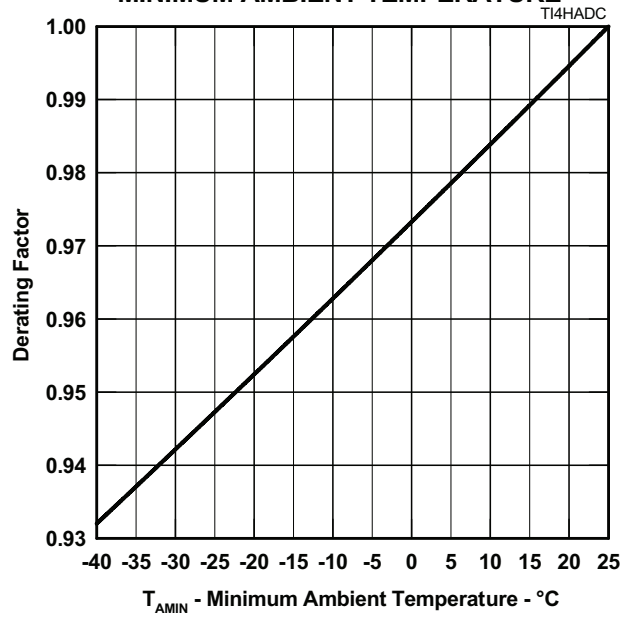

Figure 6.

Asia-Pacific: Tel: +886-2 2562-4117 • Email: asiacus@bourns.com

EMEA: Tel: +36 88 885 877 • Email: eurocus@bourns.com

The Americas: Tel: +1-951 781-5500 • Email: americus@bourns.com

www.bourns.com

NOVEMBER 2006 – REVISED APRIL 2023

Specifications are subject to change without notice.

Users should verify actual device performance in their specific applications.

The products described herein and this document are subject to specific legal disclaimers as set forth on the last page of this document, and at www.bourns.com/docs/legal/disclaimer.pdf.

TISP4A250H3BJ Overvoltage Protector

BOURNS®

Applications Information

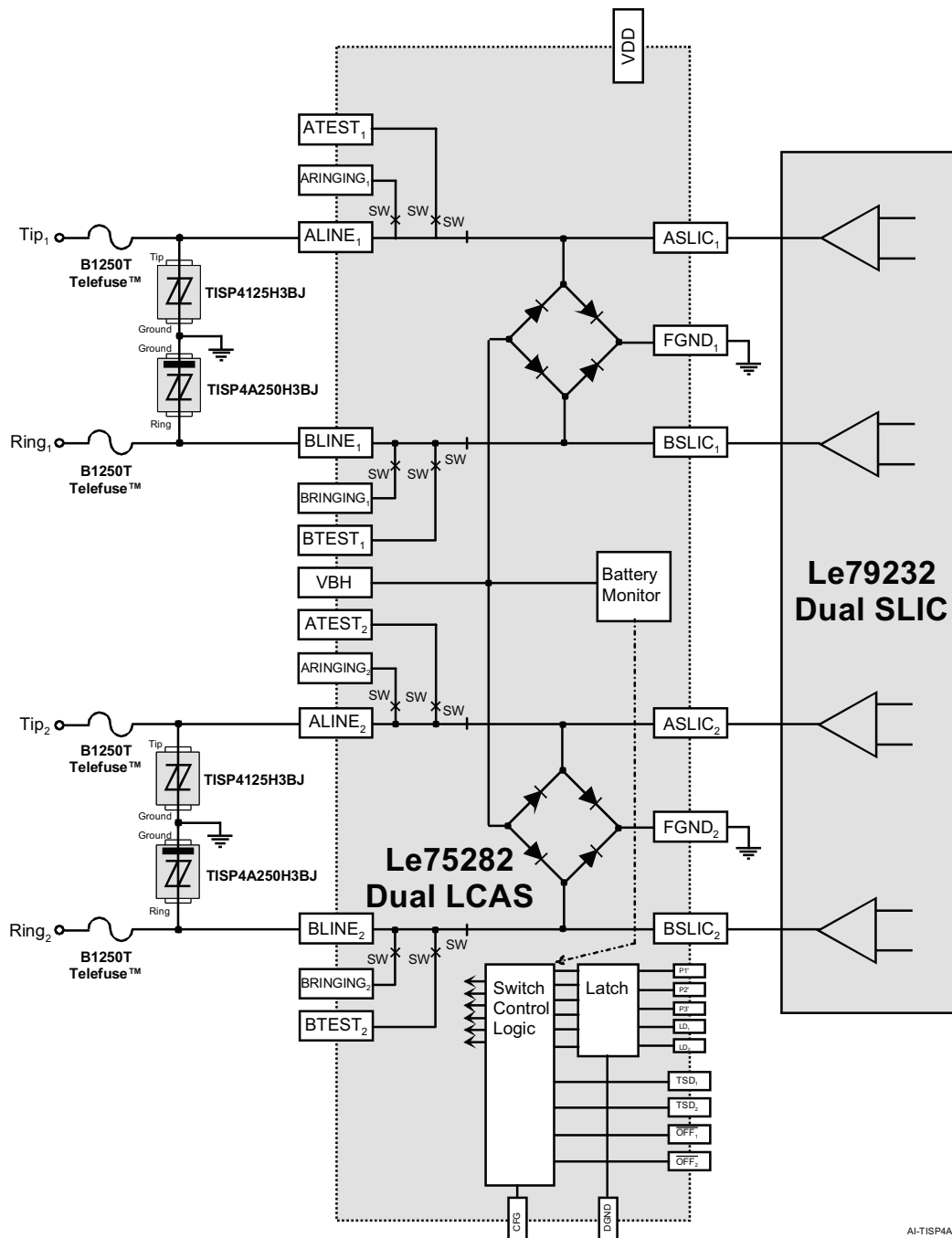

AI-TISP4A-001-a

Figure 7. Typical Application Circuit

"TISP" is a trademark of Bourns, Ltd., a Bourns Company, and is Registered in the U.S. Patent and Trademark Office. "Bourns" is a registered trademark of Bourns, Inc. in the U.S. and other countries.

NOVEMBER 2006 – REVISED APRIL 2023

Specifications are subject to change without notice.

Users should verify actual device performance in their specific applications.

The products described herein and this document are subject to specific legal disclaimers as set forth on the last page of this document, and at www.bourns.com/docs/legal/disclaimer.pdf.

This legal disclaimer applies to purchasers and users of Bourns® products manufactured by or on behalf of Bourns, Inc. and its affiliates (collectively, "Bourns").

Unless otherwise expressly indicated in writing, Bourns® products and data sheets relating thereto are subject to change without notice. Users should check for and obtain the latest relevant information and verify that such information is current and complete before placing orders for Bourns® products.

The characteristics and parameters of a Bourns® product set forth in its data sheet are based on laboratory conditions, and statements regarding the suitability of products for certain types of applications are based on Bourns' knowledge of typical requirements in generic applications. The characteristics and parameters of a Bourns® product in a user application may vary from the data sheet characteristics and parameters due to (i) the combination of the Bourns® product with other components in the user's application, or (ii) the environment of the user application itself. The characteristics and parameters of a Bourns® product also can and do vary in different applications and actual performance may vary over time. Users should always verify the actual performance of the Bourns® product in their specific devices and applications, and make their own independent judgments regarding the amount of additional test margin to design into their device or application to compensate for differences between laboratory and real world conditions.

Unless Bourns has explicitly designated an individual Bourns® product as meeting the requirements of a particular industry standard (e.g., ISO/TS 16949) or a particular qualification (e.g., UL listed or recognized), Bourns is not responsible for any failure of an individual Bourns® product to meet the requirements of such industry standard or particular qualification. Users of Bourns® products are responsible for ensuring compliance with safety-related requirements and standards applicable to their devices or applications.

Bourns® products are not recommended, authorized or intended for use in nuclear, lifesaving, life-critical or life-sustaining applications, nor in any other applications where failure or malfunction may result in personal injury, death, or severe property or environmental damage. Unless expressly and specifically approved in writing by two authorized Bourns representatives on a case-by-case basis, use of any Bourns® products in such unauthorized applications might not be safe and thus is at the user's sole risk. Life-critical applications include devices identified by the U.S. Food and Drug Administration as Class III devices and generally equivalent classifications outside of the United States.

Bourns expressly identifies those Bourns® standard products that are suitable for use in automotive applications on such products' data sheets in the section entitled "Applications." Unless expressly and specifically approved in writing by two authorized Bourns representatives on a case-by-case basis, use of any other Bourns® standard products in an automotive application might not be safe and thus is not recommended, authorized or intended and is at the user's sole risk. If Bourns expressly identifies a sub-category of automotive application in the data sheet for its standard products (such as infotainment or lighting), such identification means that Bourns has reviewed its standard product and has determined that if such Bourns® standard product is considered for potential use in automotive applications, it should only be used in such sub-category of automotive applications. Any reference to Bourns® standard product in the data sheet as compliant with the AEC-Q standard or "automotive grade" does not by itself mean that Bourns has approved such product for use in an automotive application.

Bourns® standard products are not tested to comply with United States Federal Aviation Administration standards generally or any other generally equivalent governmental organization standard applicable to products designed or manufactured for use in aircraft or space applications. Bourns expressly identifies Bourns® standard products that are suitable for use in aircraft or space applications on such products' data sheets in the section entitled "Applications." Unless expressly and specifically approved in writing by two authorized Bourns representatives on a case-by-case basis, use of any other Bourns® standard product in an aircraft or space application might not be safe and thus is not recommended, authorized or intended and is at the user's sole risk.

The use and level of testing applicable to Bourns® custom products shall be negotiated on a case-by-case basis by Bourns and the user for which such Bourns® custom products are specially designed. Absent a written agreement between Bourns and the user regarding the use and level of such testing, the above provisions applicable to Bourns® standard products shall also apply to such Bourns® custom products.

Users shall not sell, transfer, export or re-export any Bourns® products or technology for use in activities which involve the design, development, production, use or stockpiling of nuclear, chemical or biological weapons or missiles, nor shall they use Bourns® products or technology in any facility which engages in activities relating to such devices. The foregoing restrictions apply to all uses and applications that violate national or international prohibitions, including embargos or international regulations. Further, Bourns® products and Bourns technology and technical data may not under any circumstance be exported or re-exported to countries subject to international sanctions or embargoes. Bourns® products may not, without prior authorization from Bourns and/or the U.S. Government, be resold, transferred, or re-exported to any party not eligible to receive U.S. commodities, software, and technical data.

To the maximum extent permitted by applicable law, Bourns disclaims (i) any and all liability for special, punitive, consequential, incidental or indirect damages or lost revenues or lost profits, and (ii) any and all implied warranties, including implied warranties of fitness for particular purpose, non-infringement and merchantability.

For your convenience, copies of this Legal Disclaimer Notice with German, Spanish, Japanese, Traditional Chinese and Simplified Chinese bilingual versions are available at:

Web Page: <http://www.bourns.com/legal/disclaimers-terms-and-policies>

PDF: <http://www.bourns.com/docs/Legal/disclaimer.pdf>