

SPL DS90A_3

Chip

Nanostack Pulsed Laser Diode



Applications

- Industrial Automation (Machine Controls, Light Barriers, Vision Controls)
- LIDAR, Pre-Crash, ACC
- Pedestrian Protection / Lane Departure Warning

Features:

- Qualifications: The product qualification test plan is based on the guidelines of AEC-Q102, failure mechanism based Stress Test Qualification for Discrete Optoelectronic Semiconductors in Automotive applications.
- ESD: 2 kV acc. to ANSI/ESDA/JEDEC JS-001 (HBM)
- Reliable strained InGaAs/GaAs material
- High power large-optical-cavity laser structure
- Nanostack laser technology including 3 epitaxially stacked emitters
- Die attach via glueing is recommended

Ordering Information

Type	Peak output power ¹⁾ typ. P_{opt}	Ordering Code
SPL DS90A_3	120 W	Q65112A3764

Maximum Ratings

$T_A = 25\text{ °C}$

Parameter	Symbol		Values
Operating temperature	T_{op}	min.	-40 °C
		max.	105 °C
Storage temperature	T_{stg}	min.	-40 °C
		max.	105 °C
Junction temperature	T_j	max.	125 °C
Forward current	I_F	max.	40 A
Pulse width (FWHM)	t_p	max.	100 ns
Duty cycle	dc	max.	0.1 %
ESD withstand voltage acc. to ANSI/ESDA/JEDEC JS-001 (HBM)	V_{ESD}	max.	2 kV

The duty cycle must never exceed 0.1%.
This also applies within burst modes.
P-Side up gluing is recommended.

Characteristics

$I_F = 40 \text{ A}$; $t_p = 100 \text{ ns}$; $T_A = 25 \text{ °C}$; $D = 0.1 \%$

Parameter	Symbol		Values
Number of emitters	n		3
Spectral bandwidth (FWHM)	$\Delta\lambda$	typ.	7 nm
Standard pulse center wavelength ²⁾ $I_F = 5.2 \text{ A}$; $t_p = 1 \text{ }\mu\text{s}$; $D = 0.1 \%$	λ_{pulse}	min. typ. max.	894 nm 904 nm 914 nm
Peak output power ³⁾¹⁾	P_{opt}	min. typ. max.	105 W 125 W 145 W
Beam divergence (FWHM) parallel to pn-junction	Θ_{\parallel}	typ.	10 °
Beam divergence (FWHM) perpendicular to pn-junction	Θ_{\perp}	typ.	25 °
Distance between emitters (peak to peak intensity) (Vertical stacked)		typ.	4.2 μm
Differential efficiency ¹⁾ $I_F = 3 - 10 \text{ A}$	η	typ.	3.6 W / A
Threshold current	I_{th}	typ.	0.6 A
Forward voltage (bare die)	V_F	typ.	10 V
Aperture size	w x h	typ.	220 X 10 μm^2
TE polarization TE/(TE+TM), (depends strongly on chip mounting quality)	P_{TE}	typ.	99 %

For safety-related applications, 100% final testing needed after assembly at operation conditions.

Relative Spectral Emission 4), 5)

$$I_{e,rel} = f(\lambda); I_F = 40 \text{ A}; P_{opt} = 125 \text{ W}$$

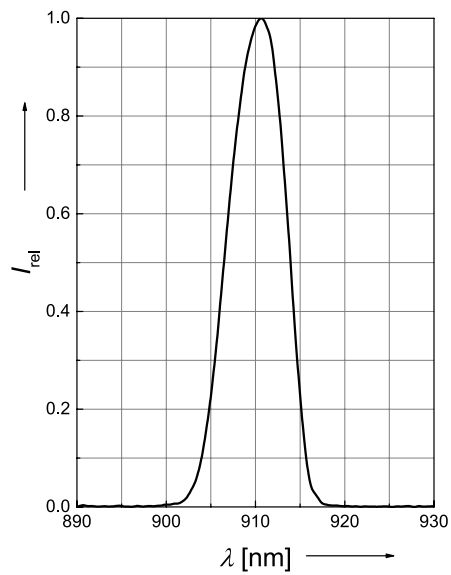
**Far-Field Distribution Parallel to pn-Junction** 4), 5)

$$I_{e,rel} = f(\Theta_{||}); P_{opt} = 125 \text{ W}$$

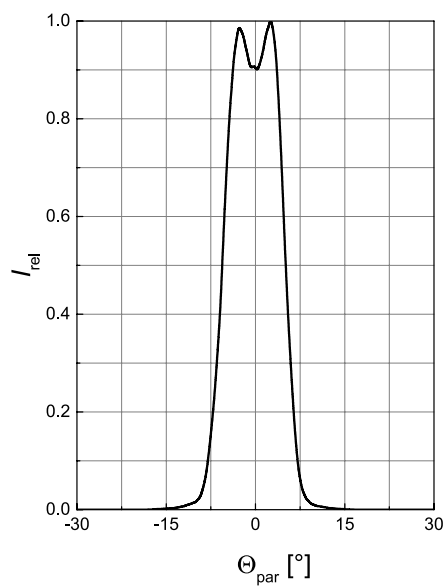

Far-Field Distribution Perpendicular to pn-Junction ^{4), 5)}

$$I_{e,rel} = f(\Theta_{\perp}); P_{opt} = 125 \text{ W}$$

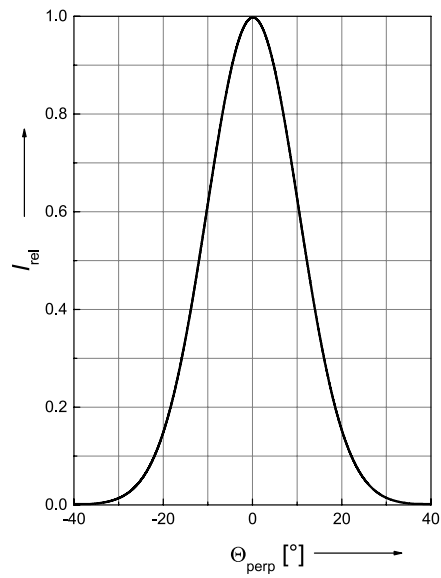

Optical Output Power ^{4), 5)}

$$P_{opt} = f(I_F)$$

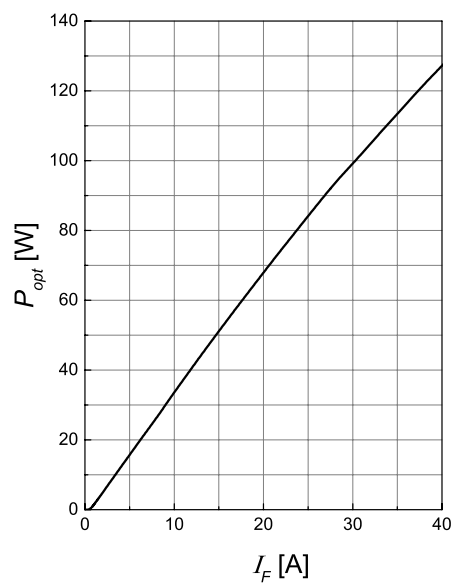

Centroid Wavelength ⁴⁾

$\lambda_{\text{centroid}} = f(T_A)$; $I_F = 40\text{A}$; $t_p = 100\text{ns}$; $f = 1\text{kHz}$; (on TO56) $P_{\text{opt}} = f(T_A)$; $I_F = 40\text{A}$; $t_p = 100\text{ns}$; $f = 1\text{kHz}$; (on TO56)

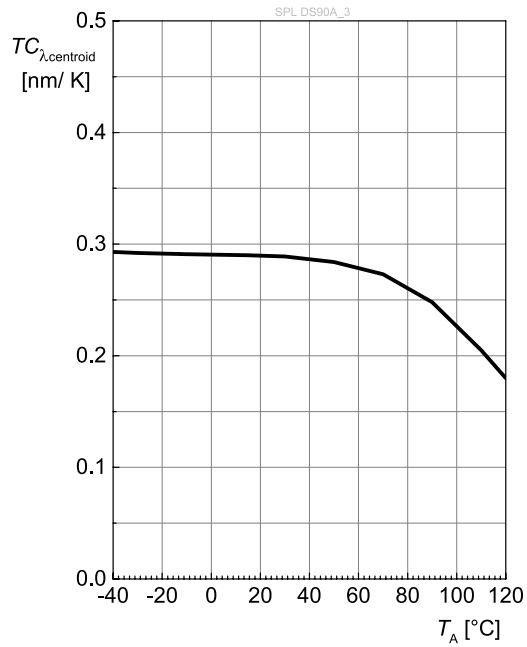

Peak Output Power

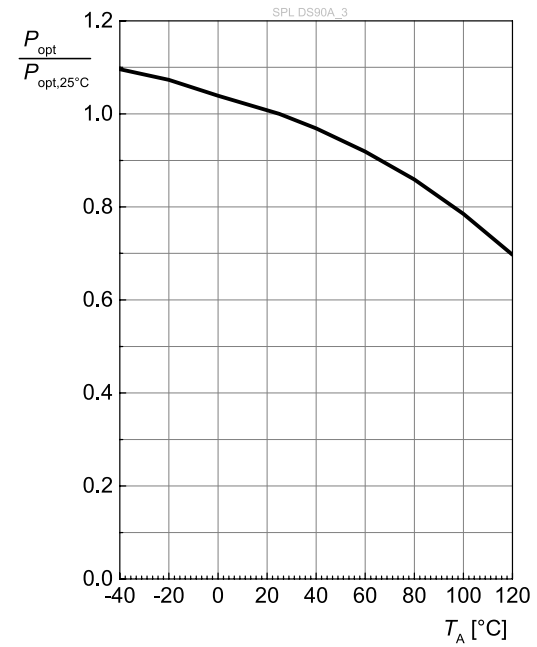

Dimensional Drawing ⁶⁾

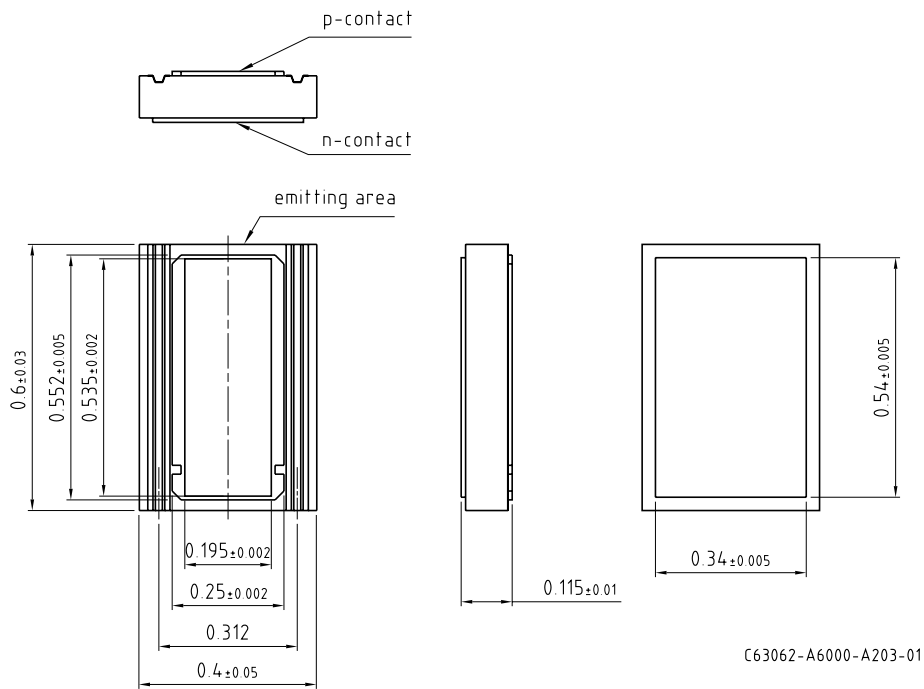

Further Information:

Approximate Weight: 0.2 g

Notes

Depending on the mode of operation, these devices emit highly concentrated non visible infrared light which can be hazardous to the human eye.

Subcomponents of this device contain, in addition to other substances, metal filled materials including silver. Metal filled materials can be affected by environments that contain traces of aggressive substances. Therefore, we recommend that customers minimize device exposure to aggressive substances during storage, production, and use.

Inked dies

The carrier frame can contain a small amount of defective parts, marked by an ink dot in the center of the defective unit.

The defective parts in each ring are not counted for total delivery quantity and shall not be used by the customer.

For further application related information please visit www.osram-os.com/appnotes

Products which incorporate these devices have to follow the safety precautions given in IEC 60825-1 and IEC 62471.

Disclaimer

Attention please!

The information describes the type of component and shall not be considered as assured characteristics. Terms of delivery and rights to change design reserved. Due to technical requirements components may contain dangerous substances.

For information on the types in question please contact our Sales Organization.

If printed or downloaded, please find the latest version on the OSRAM OS website.

AEC-Q102 qualification

The complete qualification test plan in AEC-Q102 is not applicable for bare IR laser die. Only selected tests from AEC-Q102 which are deemed relevant for bare die-related failure mechanism are performed.

Packing

Please use the recycling operators known to you. We can also help you – get in touch with your nearest sales office.

By agreement we will take packing material back, if it is sorted. You must bear the costs of transport. For packing material that is returned to us unsorted or which we are not obliged to accept, we shall have to invoice you for any costs incurred.

Product safety and functional safety devices/applications or medical devices/applications

OSRAM OS components are not developed, constructed or tested for the application as safety relevant component or for the application in medical devices.

OSRAM OS products are not qualified at module and system level for such application.

An entire (100%) testing shall be performed after assembly of the OSRAM OS product to the final product. OSRAM OS product are not qualified at module and system level for such application. Customer is fully responsible and accountable for detection capability in case of sudden changes in electro-optical characteristics at component level.

In case Buyer – or Customer supplied by Buyer– considers using OSRAM OS components in product safety and functional safety devices/applications or medical devices/applications, Buyer and/or Customer has to inform the local sales partner of OSRAM OS immediately and OSRAM OS and Buyer and /or Customer will analyze and coordinate the customer-specific request between OSRAM OS and Buyer and/or Customer.

The user of the application needs to be aware that the skin must not be exposed to the laser radiation and it can be hazardous to the human eye, depending on the mode of operation. The application shall only be operated within the range approved in the specifications released by OSRAM OS.

OSRAM OS refuses any and all kind of liability in case these instructions are not followed.

Glossary

- 1) **Optical power:** Optical power measurements refer to an integrating sphere.
- 2) **Wavelength:** The wavelengths are measured with a tolerance of ± 1 nm.
- 3) **Brightness:** The brightness values are measured with a tolerance of $\pm 11\%$.
- 4) **Typical Values:** Due to the special conditions of the manufacturing processes of semiconductor devices, the typical data or calculated correlations of technical parameters can only reflect statistical figures. These do not necessarily correspond to the actual parameters of each single product, which could differ from the typical data and calculated correlations or the typical characteristic line. If requested, e.g. because of technical improvements, these typ. data will be changed without any further notice.
- 5) **Testing temperature:** TA = 25°C (unless otherwise specified)
- 6) **Tolerance of Measure:** Unless otherwise noted in drawing, tolerances are specified with ± 0.1 and dimensions are specified in mm.

Revision History

Version	Date	Change
1.0	2018-12-03	Glossary
1.0	2018-12-05	Additional Information
1.1	2019-01-17	Applications
1.2	2019-04-05	Electro - Optical Characteristics (Diagrams)
1.3	2019-12-17	Notes
1.4	2021-06-30	Characteristics Dimensional Drawing

Published by OSRAM Opto Semiconductors GmbH EU RoHS and China RoHS compliant product
Leibnizstraße 4, D-93055 Regensburg
www.osram-os.com © All Rights Reserved.



此产品符合欧盟 RoHS 指令的要求；
按照中国的相关法规和标准，不含有毒有害物质或元素。