



# SN74LS05

## Hex Inverter with Open-drain outputs

### Product Specification

#### Specification Revision History:

Version	Date	Description
2012-06-A1	2012-06	New
2023-04-B1	2023-04	Update the template



# Contents

<b>1、 General Description.....</b>	<b>3</b>
<b>2、 Block Diagram And Pin Description .....</b>	<b>5</b>
2.1、 Block Diagram .....	5
2.2、 Pin Configurations.....	5
2.3、 Pin Description .....	6
2.4、 Function Table.....	6
<b>3、 Electrical Parameter .....</b>	<b>6</b>
3.1、 Absolute Maximum Ratings.....	6
3.2、 Recommended Operating Conditions .....	7
3.3、 Electrical Characteristics .....	7
3.3.1、 DC Characteristics 1 .....	7
3.3.2、 DC Characteristics 2 .....	8
3.3.3、 DC Characteristics 3 .....	9
3.3.4、 AC Characteristics 1 .....	10
3.3.5、 AC Characteristics 2 .....	11
3.3.6、 AC Characteristics 3 .....	11
<b>4、 Testing Circuit .....</b>	<b>12</b>
4.1、 AC Testing Circuit .....	12
4.2、 AC Testing Waveforms.....	12
4.3、 Measurement Points .....	13
4.4、 Test Data .....	13
<b>5、 Package Information .....</b>	<b>14</b>
5.1、 DIP14 .....	14
5.2、 SOP14 .....	15
5.3、 TSSOP14.....	16
<b>6、 Statements And Notes .....</b>	<b>17</b>
6.1、 The name and content of Hazardous substances or Elements in the product .....	17
6.2、 Notes .....	17



## 1、General Description

The SN74LS05 contains six inverters. The outputs of the SN74LS05 are open-drain and can be connected to other open-drain outputs to implement active-LOW wired-OR or active-HIGH wired-AND functions. The open-drain outputs require pull-up resistors to perform correctly.

### Features:

- Latch-up performance exceeds 100 mA per JESD 78 Class II level A
- Specified from -40°C to +125°C
- Packaging information: DIP14/SOP14/TSSOP14

### Ordering Information:

#### Tube packing specifications:

Part number	Packaging form	Marking code	Tube quantity	Boxed tube quantity	Boxed quantity	Notes
SN74LS05N	DIP14	SN74LS05N	25 PCS/tube	40 tube/box	1000 PCS/box	Dimensions of plastic enclosure: 19.0mm×6.4mm Pin spacing: 2.54mm
SN74LS05DR	SOP14	LS05	50 PCS/tube	200 tube/box	10000 PCS/box	Dimensions of plastic enclosure: 8.7mm×3.9mm Pin spacing: 1.27mm
SN74LS05PW	TSSOP14	LS05	96 PCS/tube	200 tube/box	19200 PCS/box	Dimensions of plastic enclosure: 5.0mm×4.4mm Pin spacing: 0.65mm



**Reel packing specifications:**

Part number	Packaging form	Marking code	Reel quantity	Boxed reel quantity	Notes
SN74LS05DR	SOP14	LS05	2500 PCS/reel	5000 PCS/box	Dimensions of plastic enclosure: 8.7mm×3.9mm Pin spacing:
SN74LS05PW	TSSOP14	LS05	5000 PCS/reel	10000 PCS/box	Dimensions of plastic enclosure: 5.0mm×4.4mm Pin spacing: 0.65mm

Note: If the physical information is inconsistent with the ordering information, please refer to the actual product.



## 2、Block Diagram And Pin Description

### 2.1、Block Diagram

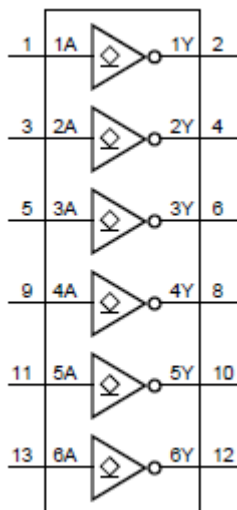

Figure 1. Logic symbol

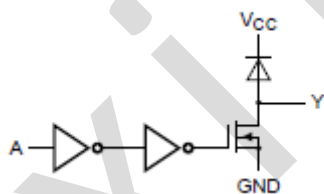
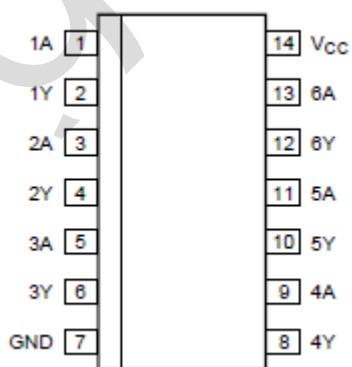

Figure 2. Logic diagram (one gate)

### 2.2、Pin Configurations





### 2.3、Pin Description

Pin No.	Pin Name	Description
1	1A	data input
2	1Y	data output
3	2A	data input
4	2Y	data output
5	3A	data input
6	3Y	data output
7	GND	ground (0V)
8	4Y	data output
9	4A	data input
10	5Y	data output
11	5A	data input
12	6Y	data output
13	6A	data input
14	V <sub>CC</sub>	supply voltage

### 2.4、Function Table

Input	Output
nA	nY
L	Z
H	L

Note: H=HIGH voltage level; L=LOW voltage level; Z=high-impedance OFF-state.

## 3、Electrical Parameter

### 3.1、Absolute Maximum Ratings

(Voltages are referenced to GND (ground=0V), unless otherwise specified.)

Parameter	Symbol	Conditions	Min.	Max.	Unit
supply voltage	V <sub>CC</sub>	-	-0.5	+7.0	V
output voltage	V <sub>O</sub>	-	-0.5	+7.0	V
input clamping current	I <sub>IK</sub>	V <sub>I</sub> <-0.5V or V <sub>I</sub> >V <sub>CC</sub> +0.5V	-	±20	mA
output clamping current	I <sub>OK</sub>	V <sub>O</sub> <-0.5V	-	-20	mA
output current	I <sub>O</sub>	-0.5V<V <sub>O</sub>	-	-25	mA
supply current	I <sub>CC</sub>	-	-	+50	mA
ground current	I <sub>GND</sub>	-	-50	-	mA
storage temperature	T <sub>stg</sub>	-	-65	+150	°C
total power dissipation	P <sub>tot</sub>	-	-	500	mW
soldering temperature	T <sub>L</sub>	10s	DIP	245	°C
			SOP/TSSOP	260	



### 3.2、Recommended Operating Conditions

Parameter	Symbol	Conditions	Min.	Typ.	Max.	Unit
supply voltage	$V_{CC}$	-	2.0	5.0	6.0	V
input voltage	$V_I$	-	0	-	$V_{CC}$	V
output voltage	$V_O$	-	0	-	$V_{CC}$	V
input transition rise and fall rate	$\Delta t/\Delta V$	$V_{CC}=2.0V$	-	-	625	ns/V
		$V_{CC}=4.5V$	-	1.67	139	ns/V
		$V_{CC}=6.0V$	-	-	83	ns/V
ambient temperature	$T_{amb}$	-	-40	-	+125	°C

### 3.3、Electrical Characteristics

#### 3.3.1、DC Characteristics 1

( $T_{amb}=25^{\circ}C$ , voltages are referenced to GND (ground=0V), unless otherwise specified.)

Parameter	Symbol	Conditions	Min	Typ	Max	Unit	
HIGH-level input voltage	$V_{IH}$	$V_{CC}=2.0V$	1.5	1.2	-	V	
		$V_{CC}=4.5V$	3.15	2.4	-	V	
		$V_{CC}=6.0V$	4.2	3.2	-	V	
LOW-level input voltage	$V_{IL}$	$V_{CC}=2.0V$	-	0.8	0.5	V	
		$V_{CC}=4.5V$	-	2.1	1.35	V	
		$V_{CC}=6.0V$	-	2.8	1.8	V	
LOW-level output voltage	$V_{OL}$	$V_I=V_{IH}$ or $V_{IL}$	$I_O=20\mu A; V_{CC}=2.0V$	-	0	0.1	V
			$I_O=20\mu A; V_{CC}=4.5V$	-	0	0.1	V
			$I_O=20\mu A; V_{CC}=6.0V$	-	0	0.1	V
			$I_O=4.0mA; V_{CC}=4.5V$	-	0.15	0.26	V
			$I_O=5.2mA; V_{CC}=6.0V$	-	0.16	0.26	V
input leakage current	$I_I$	$V_I=V_{CC}$ or GND; $V_{CC}=6.0V$	-	-	$\pm 1.0$	$\mu A$	
OFF-state output current	$I_{OZ}$	per input pin; $V_I=V_{IL}; V_O=V_{CC}$ or GND; other inputs at $V_{CC}$ or GND; $V_{CC}=6.0V; I_O=0A$	-	-	$\pm 1.0$	$\mu A$	
supply current	$I_{CC}$	$V_I=V_{CC}$ or GND; $I_O=0A; V_{CC}=6.0V$	-	-	2	$\mu A$	
input capacitance	$C_I$	-	-	3.5	-	pF	



### 3.3.2、DC Characteristics 2

( $T_{amb} = -40^{\circ}\text{C}$  to  $+85^{\circ}\text{C}$ , voltages are referenced to GND (ground=0V), unless otherwise specified.)

Parameter	Symbol	Conditions	Min.	Typ.	Max.	Unit	
HIGH-level input voltage	$V_{IH}$	$V_{CC}=2.0\text{V}$	1.5	-	-	V	
		$V_{CC}=4.5\text{V}$	3.15	-	-	V	
		$V_{CC}=6.0\text{V}$	4.2	-	-	V	
LOW-level input voltage	$V_{IL}$	$V_{CC}=2.0\text{V}$	-	-	0.5	V	
		$V_{CC}=4.5\text{V}$	-	-	1.35	V	
		$V_{CC}=6.0\text{V}$	-	-	1.8	V	
LOW-level output voltage	$V_{OL}$	$V_I = V_{IH}$ or $V_{IL}$	$I_O=20\mu\text{A}; V_{CC}=2.0\text{V}$	-	-	0.1	V
			$I_O=20\mu\text{A}; V_{CC}=4.5\text{V}$	-	-	0.1	V
			$I_O=20\mu\text{A}; V_{CC}=6.0\text{V}$	-	-	0.1	V
			$I_O=4.0\text{mA}; V_{CC}=4.5\text{V}$	-	-	0.33	V
			$I_O=5.2\text{mA}; V_{CC}=6.0\text{V}$	-	-	0.33	V
input leakage current	$I_I$	$V_I = V_{CC}$ or GND; $V_{CC}=6.0\text{V}$	-	-	$\pm 1.0$	$\mu\text{A}$	
OFF-state output current	$I_{OZ}$	per input pin; $V_I = V_{IL}$ ; $V_O = V_{CC}$ or GND; other inputs at $V_{CC}$ or GND; $V_{CC}=6.0\text{V}$ ; $I_O=0\text{A}$	-	-	$\pm 5.0$	$\mu\text{A}$	
supply current	$I_{CC}$	$V_I = V_{CC}$ or GND; $I_O=0\text{A}$ ; $V_{CC}=6.0\text{V}$	-	-	20	$\mu\text{A}$	





### 3.3.3、DC Characteristics 3

( $T_{amb} = -40^{\circ}\text{C}$  to  $+125^{\circ}\text{C}$ , voltages are referenced to GND (ground=0V), unless otherwise specified.)

Parameter	Symbol	Conditions	Min.	Typ.	Max.	Unit	
HIGH-level input voltage	$V_{IH}$	$V_{CC}=2.0\text{V}$	1.5	-	-	V	
		$V_{CC}=4.5\text{V}$	3.15	-	-	V	
		$V_{CC}=6.0\text{V}$	4.2	-	-	V	
LOW-level input voltage	$V_{IL}$	$V_{CC}=2.0\text{V}$	-	-	0.5	V	
		$V_{CC}=4.5\text{V}$	-	-	1.35	V	
		$V_{CC}=6.0\text{V}$	-	-	1.8	V	
LOW-level output voltage	$V_{OL}$	$V_I = V_{IH}$ or $V_{IL}$	$I_O=20\mu\text{A}; V_{CC}=2.0\text{V}$	-	-	0.1	V
			$I_O=20\mu\text{A}; V_{CC}=4.5\text{V}$	-	-	0.1	V
			$I_O=20\mu\text{A}; V_{CC}=6.0\text{V}$	-	-	0.1	V
			$I_O=4.0\text{mA}; V_{CC}=4.5\text{V}$	-	-	0.4	V
			$I_O=5.2\text{mA}; V_{CC}=6.0\text{V}$	-	-	0.4	V
input leakage current	$I_I$	$V_I = V_{CC}$ or GND; $V_{CC}=6.0\text{V}$	-	-	$\pm 1.0$	$\mu\text{A}$	
OFF-state output current	$I_{OZ}$	per input pin; $V_I = V_{IL}$ ; $V_O = V_{CC}$ or GND; other inputs at $V_{CC}$ or GND; $V_{CC}=6.0\text{V}$ ; $I_O=0\text{A}$	-	-	$\pm 10$	$\mu\text{A}$	
supply current	$I_{CC}$	$V_I = V_{CC}$ or GND; $I_O=0\text{A}$ ; $V_{CC}=6.0\text{V}$	-	-	40	$\mu\text{A}$	



### 3.3.4、AC Characteristics 1

( $T_{amb}=25^{\circ}\text{C}$ ,  $\text{GND}=0\text{V}$ ,  $C_L=50\text{pF}$ , unless otherwise specified.)

Parameter	Symbol	Conditions	Min.	Typ.	Max.	Unit	
nA to nY propagation delay	$t_{pd}$	see Figure 4 <sup>[1]</sup>	$V_{CC}=2.0\text{V}$	-	28	95	ns
			$V_{CC}=4.5\text{V}$	-	10	19	ns
			$V_{CC}=5.0\text{V}; C_L=15\text{pF}$	-	8	-	ns
			$V_{CC}=6.0\text{V}$	-	8	16	ns
transition time	$t_t$	see Figure 4 <sup>[2]</sup>	$V_{CC}=2.0\text{V}$	-	19	75	ns
			$V_{CC}=4.5\text{V}$	-	7	15	ns
			$V_{CC}=6.0\text{V}$	-	6	13	ns
power dissipation capacitance	$C_{PD}$	per package; $V_I=\text{GND to } V_{CC}$ <sup>[3]</sup>	-	4	-	pF	

Note:

[1]  $t_{pd}$  is the same as  $t_{PLZ}$  and  $t_{PZL}$ .

[2]  $t_t$  is the same as  $t_{THL}$ .

[3]  $C_{PD}$  is used to determine the dynamic power dissipation ( $P_D$  in uW).

$P_D=C_{PD}\times V_{CC}^2\times f_i\times N+\sum(C_L\times V_{CC}^2\times f_o)$  where:

$f_i$ =input frequency in MHz;  $f_o$ =output frequency in MHz;

$C_L$ =output load capacitance in pF;

$V_{CC}$ =supply voltage in V;

$N$ =number of inputs switching;

$\sum(C_L\times V_{CC}^2\times f_o)$ =sum of outputs.



### 3.3.5、AC Characteristics 2

( $T_{amb} = -40^{\circ}\text{C}$  to  $+85^{\circ}\text{C}$ ,  $GND = 0\text{V}$ ,  $C_L = 50\text{pF}$ , unless otherwise specified.)

Parameter	Symbol	Conditions	Min.	Typ.	Max.	Unit	
nA to nY propagation delay	$t_{pd}$	see Figure 4 <sup>[1]</sup>	$V_{CC} = 2.0\text{V}$	-	-	120	ns
			$V_{CC} = 4.5\text{V}$	-	-	24	ns
			$V_{CC} = 6.0\text{V}$	-	-	20	ns
transition time	$t_t$	see Figure 4 <sup>[2]</sup>	$V_{CC} = 2.0\text{V}$	-	-	95	ns
			$V_{CC} = 4.5\text{V}$	-	-	19	ns
			$V_{CC} = 6.0\text{V}$	-	-	16	ns

Note:

[1]  $t_{pd}$  is the same as  $t_{PLZ}$  and  $t_{PZL}$ .

[2]  $t_t$  is the same as  $t_{THL}$ .

### 3.3.6、AC Characteristics 3

( $T_{amb} = -40^{\circ}\text{C}$  to  $+125^{\circ}\text{C}$ ,  $GND = 0\text{V}$ ,  $C_L = 50\text{pF}$ , unless otherwise specified.)

Parameter	Symbol	Conditions	Min.	Typ.	Max.	Unit	
nA to nY propagation delay	$t_{pd}$	see Figure 4 <sup>[1]</sup>	$V_{CC} = 2.0\text{V}$	-	-	145	ns
			$V_{CC} = 4.5\text{V}$	-	-	29	ns
			$V_{CC} = 6.0\text{V}$	-	-	25	ns
transition time	$t_t$	see Figure 4 <sup>[2]</sup>	$V_{CC} = 2.0\text{V}$	-	-	110	ns
			$V_{CC} = 4.5\text{V}$	-	-	22	ns
			$V_{CC} = 6.0\text{V}$	-	-	19	ns

Note:

[1]  $t_{pd}$  is the same as  $t_{PLZ}$  and  $t_{PZL}$ .

[2]  $t_t$  is the same as  $t_{THL}$ .



## 4、Testing Circuit

### 4.1、AC Testing Circuit

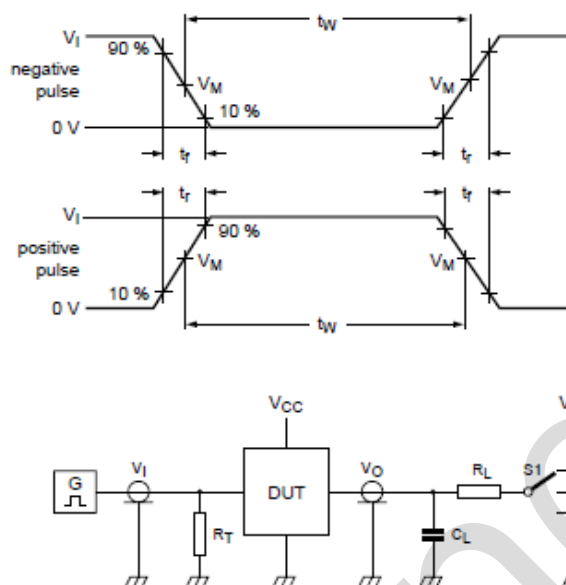

Figure 3. Test circuit for measuring switching times

Definitions for test circuit:

$C_L$ =Load capacitance including jig and probe capacitance.

$R_T$ =Termination resistance should be equal to the output impedance  $Z_o$  of the pulse generator.

$R_L$ =Load resistance.

S1=Test selection switch.

### 4.2、AC Testing Waveforms

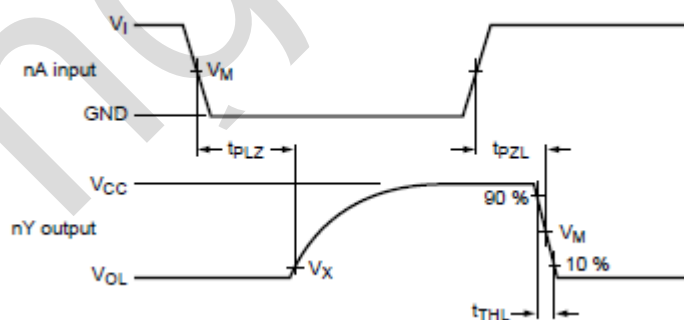

Figure 4. The input nA to output nY propagation delays and output transition times



#### 4.3、Measurement Points

Input	Output	
$V_M$	$V_M$	$V_X$
$0.5 \times V_{CC}$	$0.5 \times V_{CC}$	$0.1 \times V_{CC}$

#### 4.4、Test Data

Input		Load		S1 position
$V_I$	$t_r, t_f$	$C_L$	$R_L$	$t_{PZL}, t_{PLZ}$
$V_{CC}$	6ns	15pF, 50pF	1k $\Omega$	$V_{CC}$



## 5、Package Information

### 5.1、DIP14

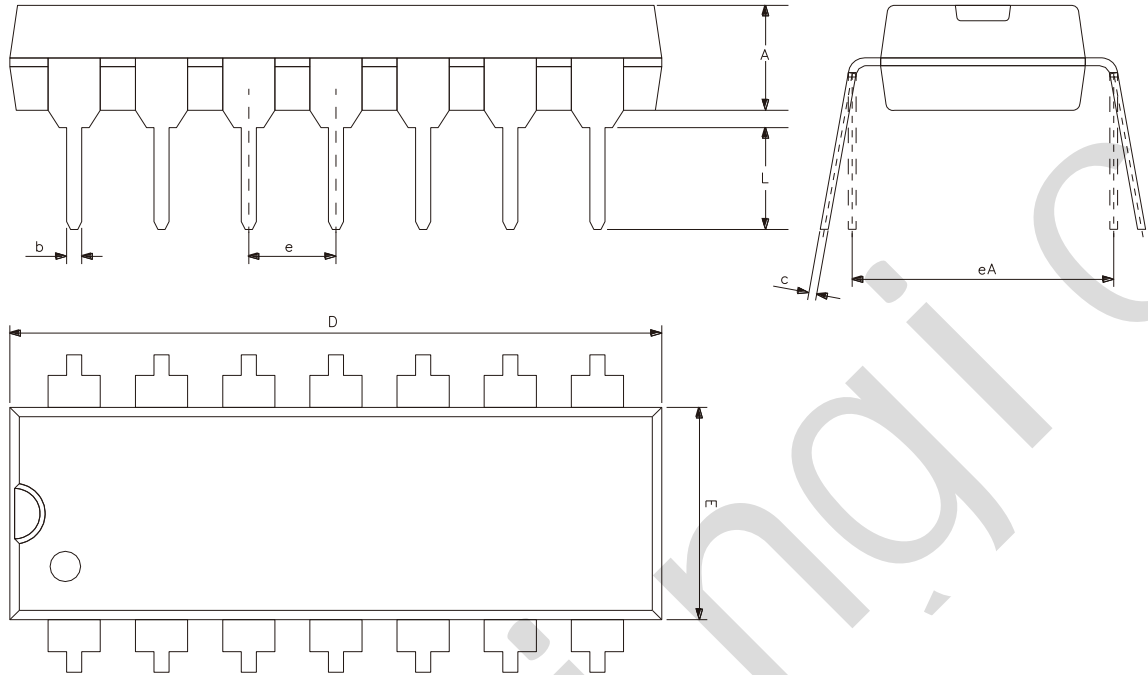

Symbol	Dimensions (mm)	
	Min.	Max.
A	3.05	3.60
b	0.33	0.56
c	0.20	0.36
D	18.80	19.40
E	6.20	6.60
e	2.54	
eA	7.62	10.90
L	2.92	-



### 5.2、SOP14

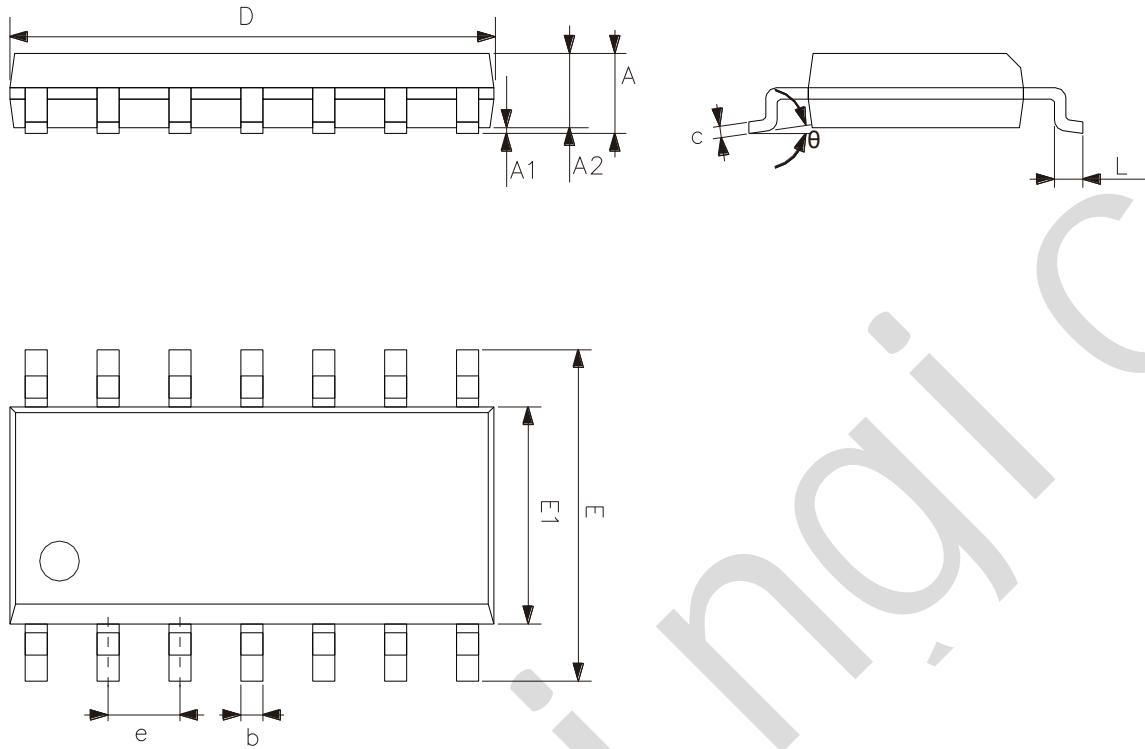

Symbol	Dimensions (mm)	
	Min.	Max.
A	1.50	1.75
A1	0.05	0.25
A2	1.30	-
b	0.33	0.50
c	0.19	0.25
D	8.43	8.76
E	5.80	6.25
E1	3.75	4.00
e	1.27	
L	0.40	0.89
$\theta$	0°	8°



### 5.3、TSSOP14

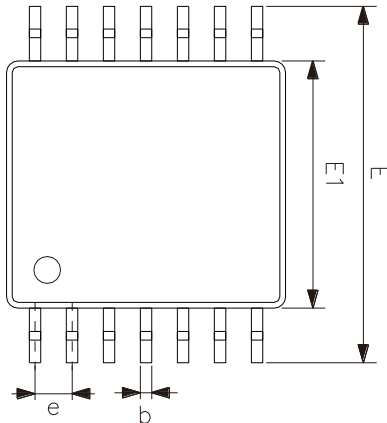
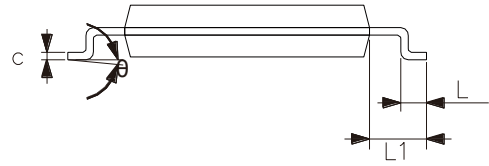
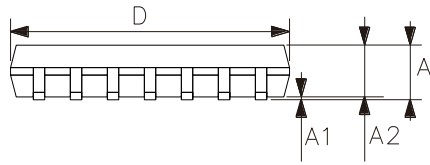

Symbol	Dimensions (mm)	
	Min.	Max.
A	-	1.20
A1	0.05	0.15
A2	0.80	1.05
b	0.19	0.30
c	0.09	0.20
D	4.90	5.10
E1	4.30	4.50
E	6.20	6.60
e	0.65	
L	0.45	0.75
L1	1.00	
$\theta$	0°	8°





## 6、 Statements And Notes

### 6.1、 The name and content of Hazardous substances or Elements in the product

Part name	Hazardous substances or Elements									
	Lead and lead compounds	Mercury and mercury compounds	Cadmium and cadmium compounds	Hexavalent chromium compounds	Polybrominated biphenyls	Polybrominated biphenyl ethers	Dibutyl phthalate	Butylbenzyl phthalate	Di-2-ethylhexyl phthalate	Diisobutyl phthalate
Lead frame	○	○	○	○	○	○	○	○	○	○
Plastic resin	○	○	○	○	○	○	○	○	○	○
Chip	○	○	○	○	○	○	○	○	○	○
The lead	○	○	○	○	○	○	○	○	○	○
Plastic sheet installed	○	○	○	○	○	○	○	○	○	○
explanation	○: Indicates that the content of hazardous substances or elements in the detection limit of the following the SJ/T11363-2006 standard. ×: Indicates that the content of hazardous substances or elements exceeding the SJ/T11363-2006 Standard limit requirements.									

### 6.2、 Notes

We Recommend you to read this chapter carefully before using this product.

The information in this chapter is provided for reference only and Lingxing disclaims any express or implied warranties, including but not limited to applicability, special application or non-infringement of third party rights.

This product is not suitable for critical equipment such as life-saving, life-sustaining or safety equipment. It is also not suitable for applications that may result in personal injury, death, or serious property or environmental damage due to product malfunction or failure. Lingxing will not be liable for any damages incurred by the customers at their own risk for such applications.

The customer is responsible for conducting all necessary tests Lingxing's application to avoid failure in the application or the application of the customer's third party users. Lingxing does not accept any liability.

The Company reserves the right to change or improve the information published in this chapter at any time. The information in this chapter are subject to change without notice. We recommend the customer to consult our sales staff before purchasing.

Please obtain related materials form Lingxing's regular channels and we are not responsible for its content if it is provided by sources other than our company.

In case of any conflict between the Chinese and English version, the version is subject to the Chinese one.