

Description

The TSV6292, TSV6294 dual and quad operational amplifiers offer a high bandwidth of 1.3 MHz while consuming only 29 μ A. They must be used in a gain configuration (equal or above +4 or -3).

The TSV6292, TSV6294 features low voltage, low power operation and rail-to-rail input and output. The devices also offer an ultra-low input bias current and low input offset voltage.

These features make the TSV6292, TSV6294 family ideal for sensor interfaces, battery supplied and portable applications, as well as active filtering.

Features

- Rail-to-rail input and output
- Low power consumption: 29 μ A typ, 36 μ A max
- Low supply voltage: 1.5 – 5.5 V
- High gain bandwidth product: 1.3 MHz typ
- Stable when used in gain configuration
- Low power shutdown mode: 5 nA typ
- Good accuracy: 800 μ V max (A version)
- Low input bias current: 1 pA typ
- EMI hardened operational amplifiers
- High tolerance to ESD: 4 kV HBM
- Extended temperature range: -40 to +125° C

Applications

- Battery-powered applications
- Portable devices
- Signal conditioning
- Active filtering
- Medical instrumentation

Package pin connections

Figure 1. Pin connections for each package (top view)

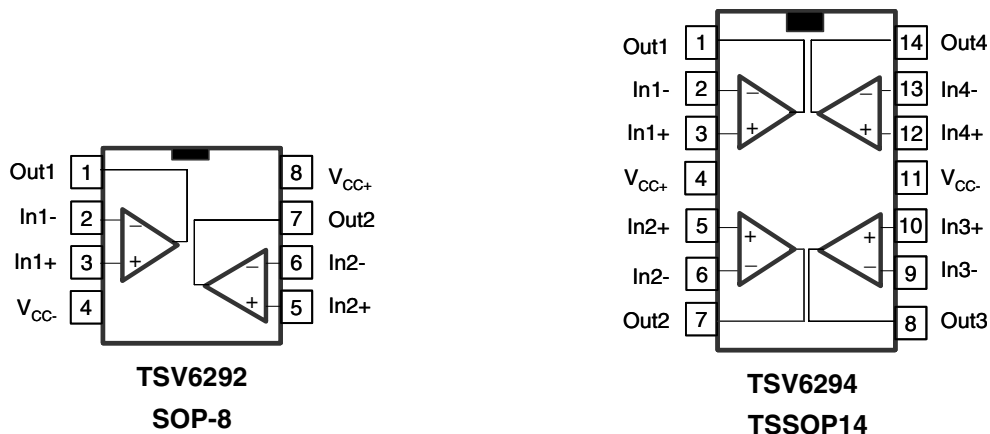

Absolute maximum ratings and operating conditions

Table 2. Absolute maximum ratings (AMR)

Symbol	Parameter	Value	Unit
V_{CC}	Supply voltage ⁽¹⁾	6	V
V_{id}	Differential input voltage ⁽²⁾	$\pm V_{CC}$	V
V_{in}	Input voltage ⁽³⁾	$V_{CC-} - 0.2$ to $V_{CC+} + 0.2$	V
I_{in}	Input current ⁽⁴⁾	10	mA
\overline{SHDN}	Shutdown voltage ⁽³⁾	$V_{CC-} - 0.2$ to $V_{CC+} + 0.2$	V
T_{stg}	Storage temperature	-65 to +150	°C
R_{thja}	Thermal resistance junction to ambient ⁽⁵⁾⁽⁶⁾		
	SOP-8	125	°C/W
	TSSOP14	100	
T_j	Maximum junction temperature	150	°C
ESD	HBM: human body model ⁽⁷⁾	4	kV
	MM: machine model ⁽⁸⁾	200	V
	CDM: charged device model ⁽⁹⁾	1.5	kV
	Latch-up immunity	200	mA

- All voltage values, except differential voltages are with respect to network ground terminal.
- Differential voltages are the non-inverting input terminal with respect to the inverting input terminal.
- $V_{CC} - V_{in}$ must not exceed 6 V, V_{in} must not exceed 6V.
- Input current must be limited by a resistor in series with the inputs.
- Short-circuits can cause excessive heating and destructive dissipation.
- R_{th} are typical values.
- Human body model: 100 pF discharged through a 1.5 k Ω resistor between two pins of the device, done for all couples of pin combinations with other pins floating.
- Machine model: a 200 pF capacitor is charged to the specified voltage, then discharged directly between two pins of the device with no external series resistor (internal resistor < 5 Ω), done for all couples of pin combinations with other pins floating.
- Charged device model: all pins plus package are charged together to the specified voltage and then discharged directly to ground.

Table 3. Operating conditions

Symbol	Parameter	Value	Unit
V_{CC}	Supply voltage	1.5 to 5.5	V
V_{icm}	Common mode input voltage range	$V_{CC-} - 0.1$ to $V_{CC+} + 0.1$	V
T_{oper}	Operating free air temperature range	-40 to +125	°C

Electrical characteristics

Table 4. Electrical characteristics at $V_{CC+} = +1.8$ V with $V_{CC-} = 0$ V, $V_{icm} = V_{CC}/2$, $T_{amb} = 25^\circ$ C, and R_L connected to $V_{CC}/2$ (unless otherwise specified)

Symbol	Parameter	Conditions	Min.	Typ.	Max.	Unit
DC performance						
V_{io}	Offset voltage	TSV629x			4	mV
		TSV629xA			0.8	
		TSV629x - $T_{min} < T_{op} < T_{max}$			6	
		TSV629xA - $T_{min} < T_{op} < T_{max}$			2	
DV_{io}	Input offset voltage drift			2		$\mu V/^\circ C$
I_{io}	Input offset current ($V_{out} = V_{CC}/2$)			1	$10^{(1)}$	pA
		$T_{min} < T_{op} < T_{max}$		1	100	pA
I_{ib}	Input bias current ($V_{out} = V_{CC}/2$)			1	$10^{(1)}$	pA
		$T_{min} < T_{op} < T_{max}$		1	100	pA
CMR	Common mode rejection ratio $20 \log (\Delta V_{ic}/\Delta V_{io})$	0 V to 1.8 V, $V_{out} = 0.9$ V	53	74		dB
		$T_{min} < T_{op} < T_{max}$	51			dB
A_{vd}	Large signal voltage gain	$R_L = 10$ k Ω , $V_{out} = 0.5$ V to 1.3 V	78	95		dB
		$T_{min} < T_{op} < T_{max}$	73			dB
V_{OH}	High level output voltage	$R_L = 10$ k Ω $T_{min} < T_{op} < T_{max}$	35 50	5		mV
V_{OL}	Low level output voltage	$R_L = 10$ k Ω $T_{min} < T_{op} < T_{max}$		4	35 50	mV
I_{out}	Isink	$V_{out} = 1.8$ V	6	12		mA
		$T_{min} < T_{op} < T_{max}$	4			
	Isource	$V_{out} = 0$ V	6	10		
		$T_{min} < T_{op} < T_{max}$	4			
I_{CC}	Supply current (per operator)	No load, $V_{out} = V_{CC}/2$		25	31	μA
		$T_{min} < T_{op} < T_{max}$			33	μA
AC performance						
GBP	Gain bandwidth product	$R_L = 10$ k Ω , $C_L = 100$ pF		1.1		MHz
Gain	Minimum gain for stability	Phase margin = 60° , $R_f = 10$ k Ω , $R_L = 10$ k Ω , $C_L = 20$ pF, $T_{op} = 25^\circ$ C		+4 -3		V/V
SR	Slew rate	$R_L = 10$ k Ω , $C_L = 100$ pF, $V_{out} = 0.5$ V to 1.3V		0.33		V/ μs

1. Guaranteed by design.

Table 5. Shutdown characteristics $V_{CC} = 1.8\text{ V}$

Symbol	Parameter	Conditions	Min.	Typ.	Max.	Unit
DC performance						
I_{CC}	Supply current in shutdown mode (all operators)	$\overline{\text{SHDN}} = V_{CC-}$		2.5	50	nA
		$T_{\min} < T_{op} < 85^{\circ}\text{ C}$			200	nA
		$T_{\min} < T_{op} < 125^{\circ}\text{ C}$			1.5	μA
t_{on}	Amplifier turn-on time	$R_L = 5\text{ k}$, $V_{out} = V_{CC-}$ to $V_{CC-} + 0.2\text{ V}$		200		ns
t_{off}	Amplifier turn-off time	$R_L = 5\text{ k}$, $V_{out} = V_{CC+} - 0.5\text{ V}$ to $V_{CC+} - 0.7\text{ V}$		20		ns
V_{IH}	$\overline{\text{SHDN}}$ logic high		1.35			V
V_{IL}	$\overline{\text{SHDN}}$ logic low				0.6	V
I_{IH}	$\overline{\text{SHDN}}$ current high	$\overline{\text{SHDN}} = V_{CC+}$		10		μA
I_{IL}	$\overline{\text{SHDN}}$ current low	$\overline{\text{SHDN}} = V_{CC-}$		10		μA
I_{OLeak}	Output leakage in shutdown mode	$\overline{\text{SHDN}} = V_{CC-}$		50		μA
		$T_{\min} < T_{op} < 125^{\circ}\text{ C}$		1		nA

Table 6. $V_{CC+} = +3.3\text{ V}$, $V_{CC-} = 0\text{ V}$, $V_{icm} = V_{CC}/2$, $T_{amb} = 25^\circ\text{ C}$, R_L connected to $V_{CC}/2$
 (unless otherwise specified)

Symbol	Parameter	Conditions	Min.	Typ.	Max.	Unit
DC performance						
V_{io}	Offset voltage	TSV629x TSV629xA			4 0.8	mV
		TSV629x - $T_{min} < T_{op} < T_{max}$ TSV629xA - $T_{min} < T_{op} < T_{max}$			6 2	
DV_{io}	Input offset voltage drift			2		$\mu\text{V}/^\circ\text{C}$
I_{io}	Input offset current			1	$10^{(1)}$	pA
		$T_{min} < T_{op} < T_{max}$		1	100	pA
I_{ib}	Input bias current			1	$10^{(1)}$	pA
		$T_{min} < T_{op} < T_{max}$		1	100	pA
CMR	Common mode rejection ratio $20 \log (\Delta V_{ic}/\Delta V_{io})$	0 V to 3.3 V, $V_{out} = 1.65\text{ V}$	57	79		dB
		$T_{min} < T_{op} < T_{max}$	53			dB
A_{vd}	Large signal voltage gain	$R_L = 10\text{ k}\Omega$, $V_{out} = 0.5\text{ V to } 2.8\text{ V}$	81	98		dB
		$T_{min} < T_{op} < T_{max}$	76			dB
V_{OH}	High level output voltage	$R_L = 10\text{ k}\Omega$ $T_{min} < T_{op} < T_{max}$	35 50	5		mV
V_{OL}	Low level output voltage	$R_L = 10\text{ k}\Omega$ $T_{min} < T_{op} < T_{max}$		4	35 50	mV
I_{out}	Isink	$V_o = 5\text{ V}$	23	45		mA
		$T_{min} < T_{op} < T_{max}$	20			
	Isource	$V_o = 0\text{ V}$	23	38		mA
		$T_{min} < T_{op} < T_{max}$	20			
I_{CC}	Supply current (per operator)	No load, $V_{out} = 2.5\text{ V}$		26	33	μA
		$T_{min} < T_{op} < T_{max}$			35	μA
AC performance						
GBP	Gain bandwidth product	$R_L = 10\text{ k}\Omega$, $C_L = 100\text{ pF}$		1.2		MHz
Gain	Minimum gain for stability	Phase margin = 60° , $R_f = 10\text{ k}\Omega$, $R_L = 10\text{ k}\Omega$, $C_L = 20\text{ pF}$, $T_{op} = 25^\circ\text{ C}$		+4 -3		V/V
SR	Slew rate	$R_L = 10\text{ k}\Omega$, $C_L = 100\text{ pF}$, $V_{out} = 0.5\text{ V to } 2.8\text{ V}$		0.4		V/ μs

1. Guaranteed by design.

Table 7. $V_{CC+} = +5\text{ V}$, $V_{CC-} = 0\text{ V}$, $V_{icm} = V_{CC}/2$, $T_{amb} = 25^\circ\text{ C}$, R_L connected to $V_{CC}/2$
 (unless otherwise specified)

Symbol	Parameter	Conditions	Min.	Typ.	Max.	Unit
DC performance						
V_{io}	Offset voltage	TSV629x TSV629xA			4 0.8	mV
		TSV629x - $T_{min} < T_{op} < T_{max}$ TSV629xA - $T_{min} < T_{op} < T_{max}$			6 2	
DV_{io}	Input offset voltage drift			2		$\mu\text{V}/^\circ\text{C}$
I_{io}	Input offset current			1	$10^{(1)}$	pA
		$T_{min} < T_{op} < T_{max}$		1	100	pA
I_{ib}	Input bias current			1	$10^{(1)}$	pA
		$T_{min} < T_{op} < T_{max}$		1	100	pA
CMR	Common mode rejection ratio $20 \log (\Delta V_{ic}/\Delta V_{io})$	0 V to 5 V, $V_{out} = 2.5\text{ V}$	60	80		dB
		$T_{min} < T_{op} < T_{max}$	55			
A_{vd}	Large signal voltage gain	$R_L = 10\text{ k}\Omega$, $V_{out} = 0.5\text{ V to } 4.5\text{ V}$	85	98		dB
		$T_{min} < T_{op} < T_{max}$	80			
SVR	Supply voltage rejection ratio $20 \log (\Delta V_{CC}/\Delta V_{io})$	$V_{CC} = 1.8\text{ to } 5\text{ V}$	75	102		dB
		$T_{min} < T_{op} < T_{max}$	73			
EMIRR	EMI rejection ratio $EMIRR = -20 \log (V_{RFpeak}/\Delta V_{io})$	$V_{RF} = 100\text{ mV}_{rms}$, $f = 400\text{ MHz}$		61		dB
		$V_{RF} = 100\text{ mV}_{rms}$, $f = 900\text{ MHz}$		85		
		$V_{RF} = 100\text{ mV}_{rms}$, $f = 1800\text{ MHz}$		92		
		$V_{RF} = 100\text{ mV}_{rms}$, $f = 2400\text{ MHz}$		83		
V_{OH}	High level output voltage	$R_L = 10\text{ k}\Omega$	35	7		mV
		$T_{min} < T_{op} < T_{max}$	50			
V_{OL}	Low level output voltage	$R_L = 10\text{ k}\Omega$		6	35	mV
		$T_{min} < T_{op} < T_{max}$			50	
I_{out}	I_{sink}	$V_o = 5\text{ V}$	40	69		mA
		$T_{min} < T_{op} < T_{max}$	35			
	I_{source}	$V_o = 0\text{ V}$	40	74		mA
		$T_{min} < T_{op} < T_{max}$	35			
I_{CC}	Supply current (per operator)	No load, $V_{out} = 2.5\text{ V}$		29	36	μA
		$T_{min} < T_{op} < T_{max}$			38	μA

Table 7. $V_{CC+} = +5\text{ V}$, $V_{CC-} = 0\text{ V}$, $V_{icm} = V_{CC}/2$, $T_{amb} = 25^\circ\text{ C}$, R_L connected to $V_{CC}/2$
 (unless otherwise specified) (continued)

Symbol	Parameter	Conditions	Min.	Typ.	Max.	Unit
AC performance						
GBP	Gain bandwidth product	$R_L = 10\text{ k}\Omega$, $C_L = 100\text{ pF}$		1.3		MHz
Gain	Minimum gain for stability	Phase margin = 60° , $R_f = 10\text{ k}\Omega$, $R_L = 10\text{ k}\Omega$, $C_L = 20\text{ pF}$, $T_{op} = 25^\circ\text{ C}$		+4 -3		V/V
SR	Slew rate	$R_L = 10\text{ k}\Omega$, $C_L = 100\text{ pF}$, $V_{out} = 0.5\text{ V}$ to 4.5 V		0.5		V/ μs
e_n	Equivalent input noise voltage	$f = 1\text{ kHz}$		77		$\frac{\text{nV}}{\sqrt{\text{Hz}}}$
THD+N	Total harmonic distortion + noise	$A_v = -10$, $f_{in} = 1\text{ kHz}$, $R_L = 100\text{ k}\Omega$, $V_{icm} = V_{CC}/2$, $V_{out} = 1\text{ V}_{rms}$, $BW = 22\text{ kHz}$		0.03		%

1. Guaranteed by design.

Table 8. Shutdown characteristics at $V_{CC} = 5\text{ V}$

Symbol	Parameter	Conditions	Min.	Typ.	Max.	Unit
DC performance						
I_{CC}	Supply current in shutdown mode (all operators)	$\overline{\text{SHDN}} = V_{IL}$		5	50	nA
		$T_{min} < T_{op} < 85^\circ\text{ C}$			200	nA
		$T_{min} < T_{op} < 125^\circ\text{ C}$			1.5	μA
t_{on}	Amplifier turn-on time	$R_L = 5\text{ k}\Omega$, $V_{out} = V_{CC-}$ to $V_{CC+} + 0.2\text{ V}$		200		ns
t_{off}	Amplifier turn-off time	$R_L = 5\text{ k}\Omega$, $V_{out} = V_{CC+} - 0.5\text{ V}$ to $V_{CC+} - 0.7\text{ V}$		20		ns
V_{IH}	$\overline{\text{SHDN}}$ logic high		2			V
V_{IL}	$\overline{\text{SHDN}}$ logic low				0.8	V
I_{IH}	$\overline{\text{SHDN}}$ current high	$\overline{\text{SHDN}} = V_{CC+}$		10		μA
I_{IL}	$\overline{\text{SHDN}}$ current low	$\overline{\text{SHDN}} = V_{CC-}$		10		μA
I_{OLeak}	Output leakage in shutdown mode	$\overline{\text{SHDN}} = V_{CC-}$		50		μA
		$T_{min} < T_{op} < 125^\circ\text{ C}$		1		nA

Figure 2. Supply current vs. supply voltage at $V_{icm} = V_{CC}/2$

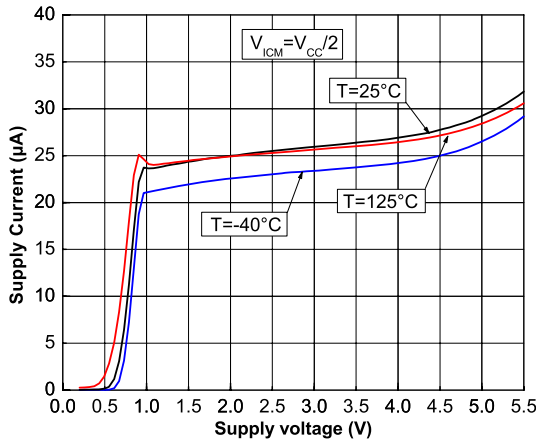

Figure 3. Output current vs. output voltage at $V_{CC} = 1.5 V$

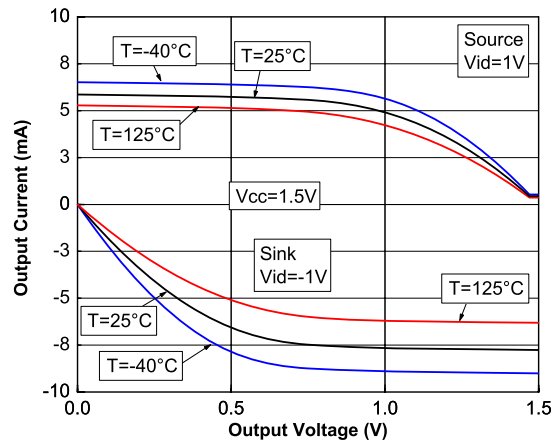

Figure 4. Output current vs. output voltage at $V_{CC} = 5 V$

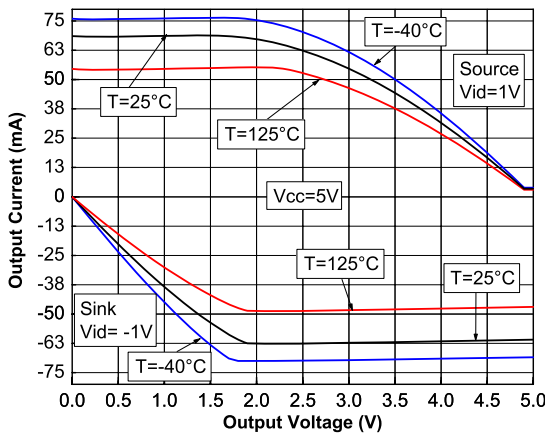

Figure 5. Closed loop frequency response, gain = -10 at $V_{CC} = 1.5 V$ & $V_{CC} = 5 V$

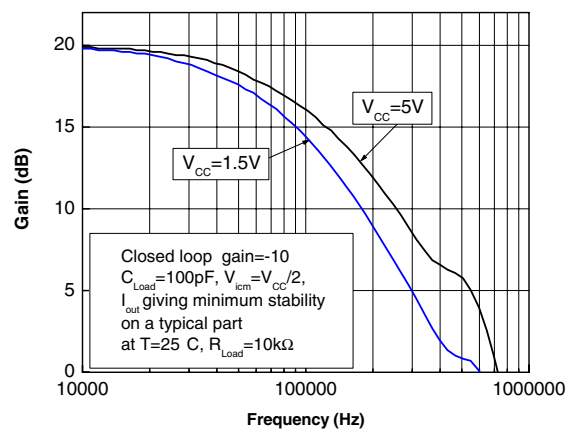

Figure 6. Closed loop frequency response, gain = -3, $V_{CC} = 1.5 V$

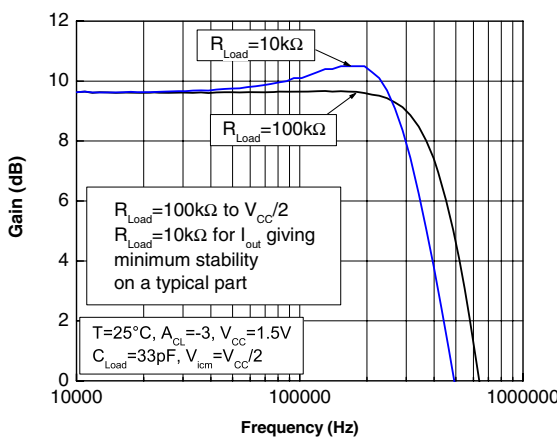

Figure 7. Closed loop frequency response, gain = -3, $V_{CC} = 5 V$

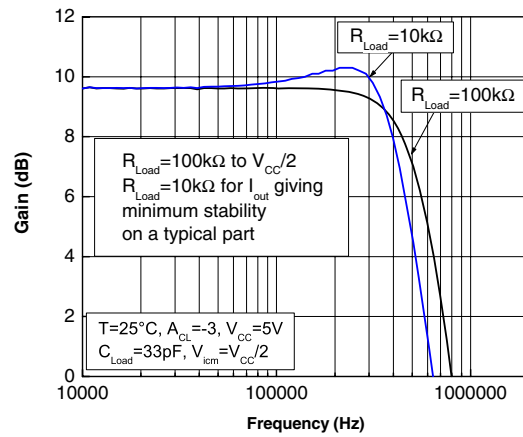

Figure 8. Positive slew rate vs. supply voltage in closed loop

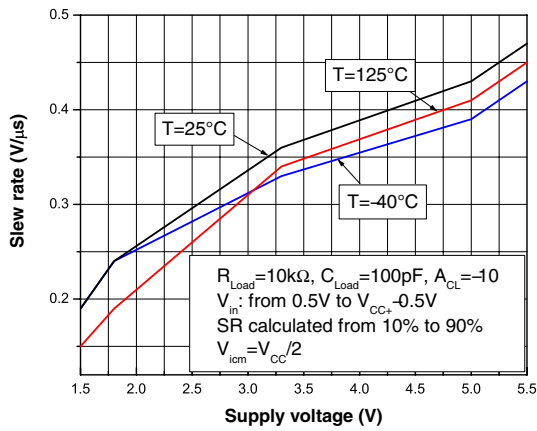

Figure 9. Negative slew rate vs. supply voltage in closed loop

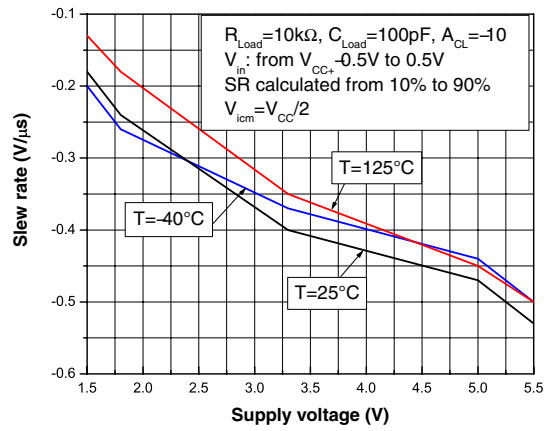

Figure 10. Slew rate vs. supply voltage in open loop

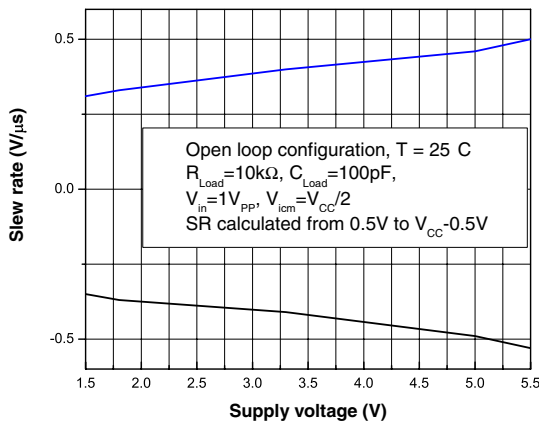

Figure 11. Slew rate timing in open loop

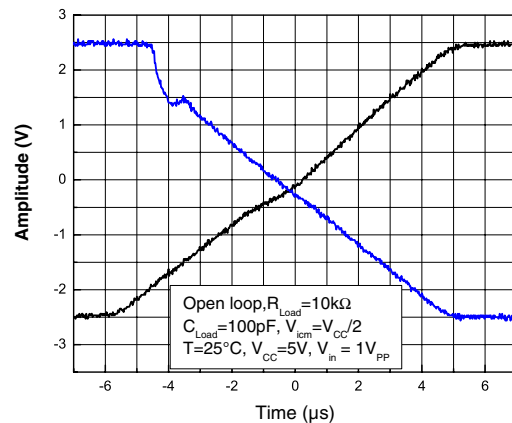

Figure 12. Slew rate timing in closed loop

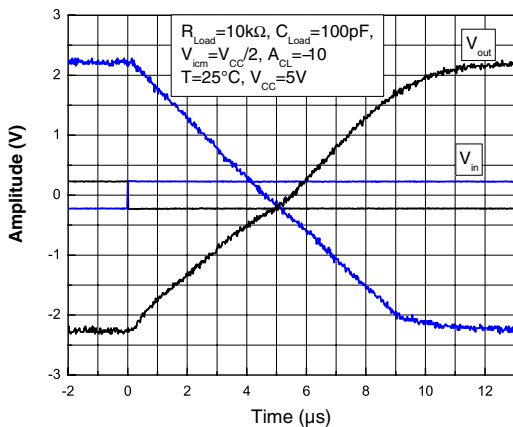

Figure 13. Noise at V_{CC} = 5 V

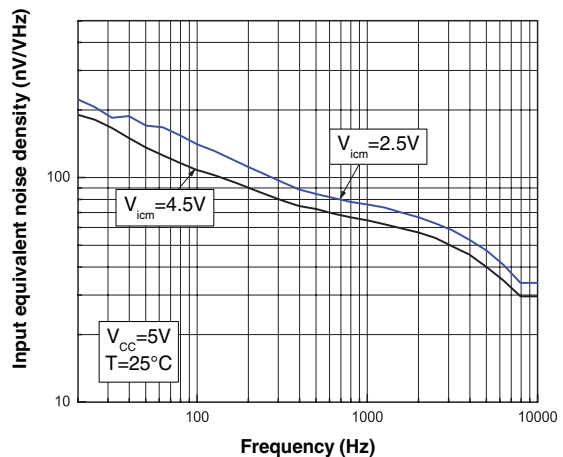

Figure 14. Distortion + noise vs. output voltage at $V_{CC} = 1.8\text{ V}$

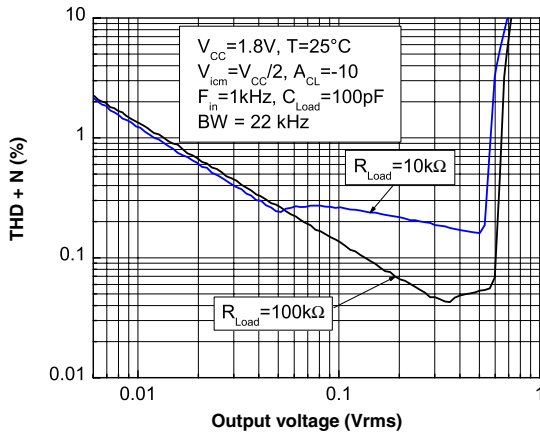

Figure 15. Distortion + noise vs. output voltage at $V_{CC} = 5\text{ V}$

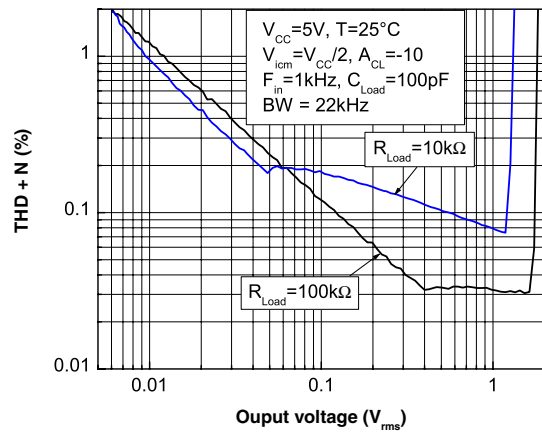

Figure 16. Distortion + noise vs. frequency at $V_{CC} = 1.8\text{ V}$

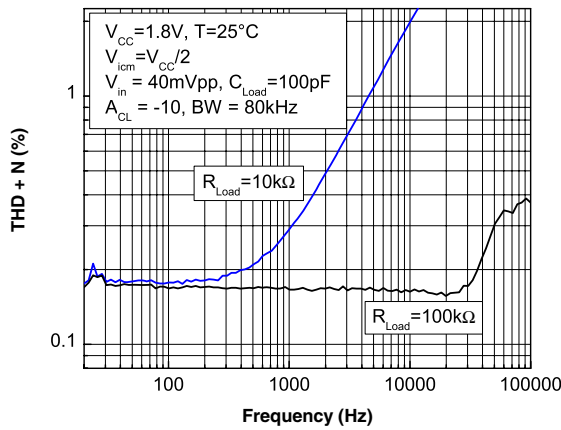

Figure 17. Distortion + noise vs. frequency at $V_{CC} = 5\text{ V}$

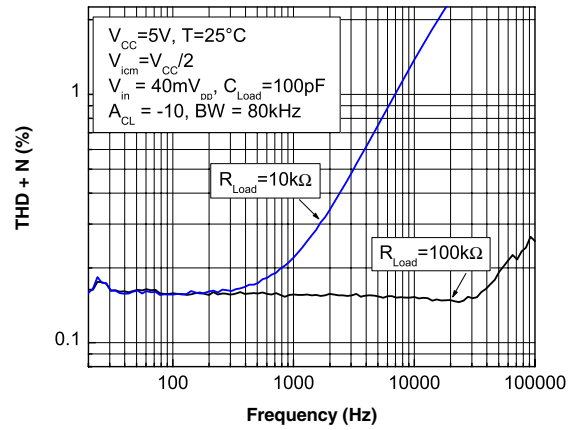
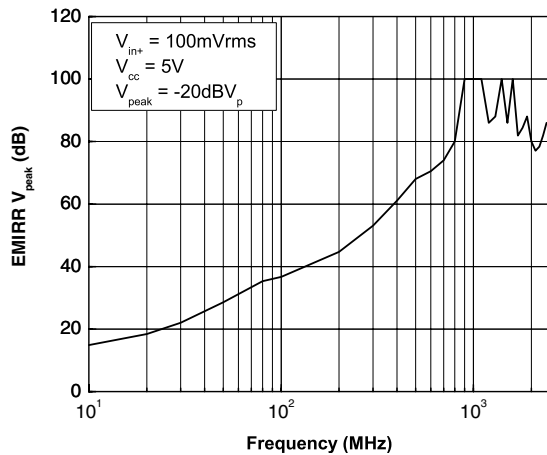

Figure 18. EMIRR vs. frequency at $V_{CC} = 5\text{ V}$, $T = 25^\circ\text{ C}$



Application information

Figure 19. Input offset voltage vs input common mode at $V_{CC} = 1.5\text{ V}$

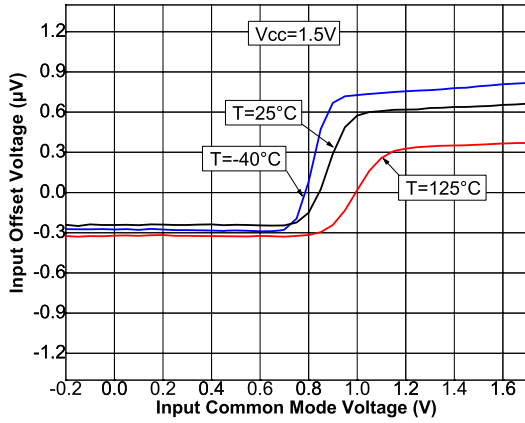
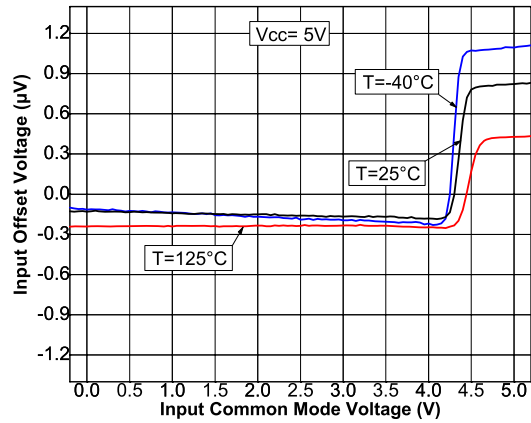

Figure 20. Input offset voltage vs input common mode at $V_{CC} = 5\text{ V}$



The devices are guaranteed without phase reversal.

Figure 21. Test configuration for turn-on time (V_{out} pulled down)

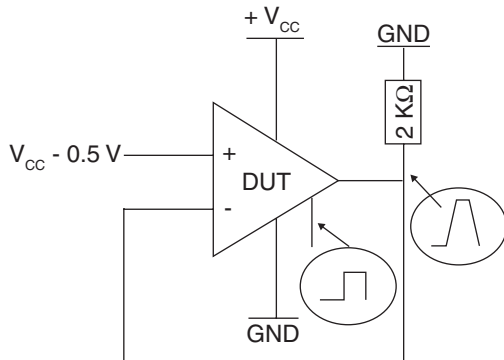

Figure 22. Test configuration for turn-off time (V_{out} pulled down)

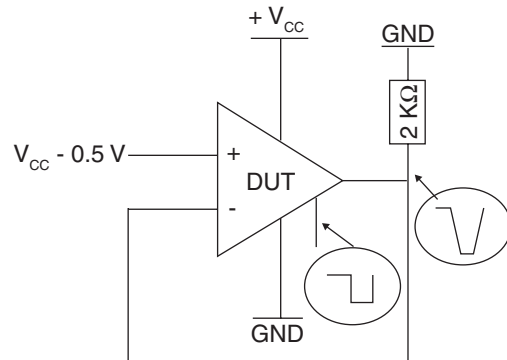

Figure 23. Turn-on time, $V_{CC} = 5\text{ V}$, V_{out} pulled down, $T = 25^\circ\text{ C}$

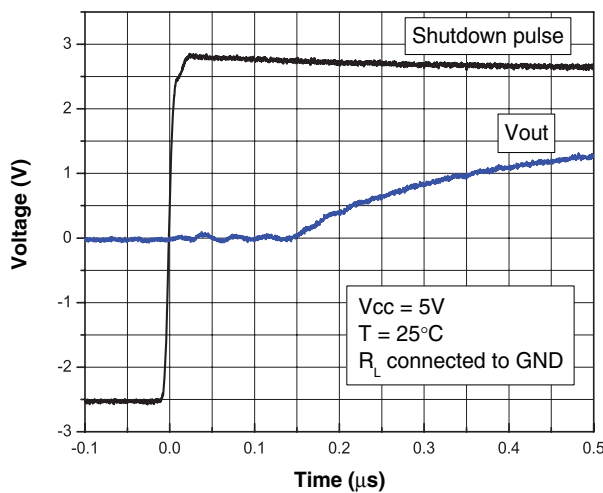
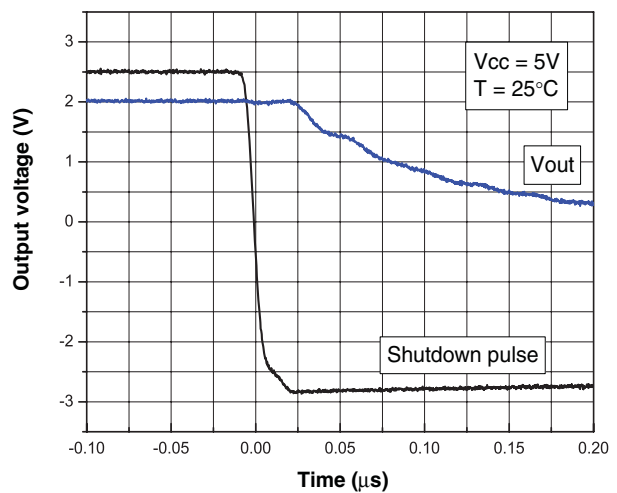
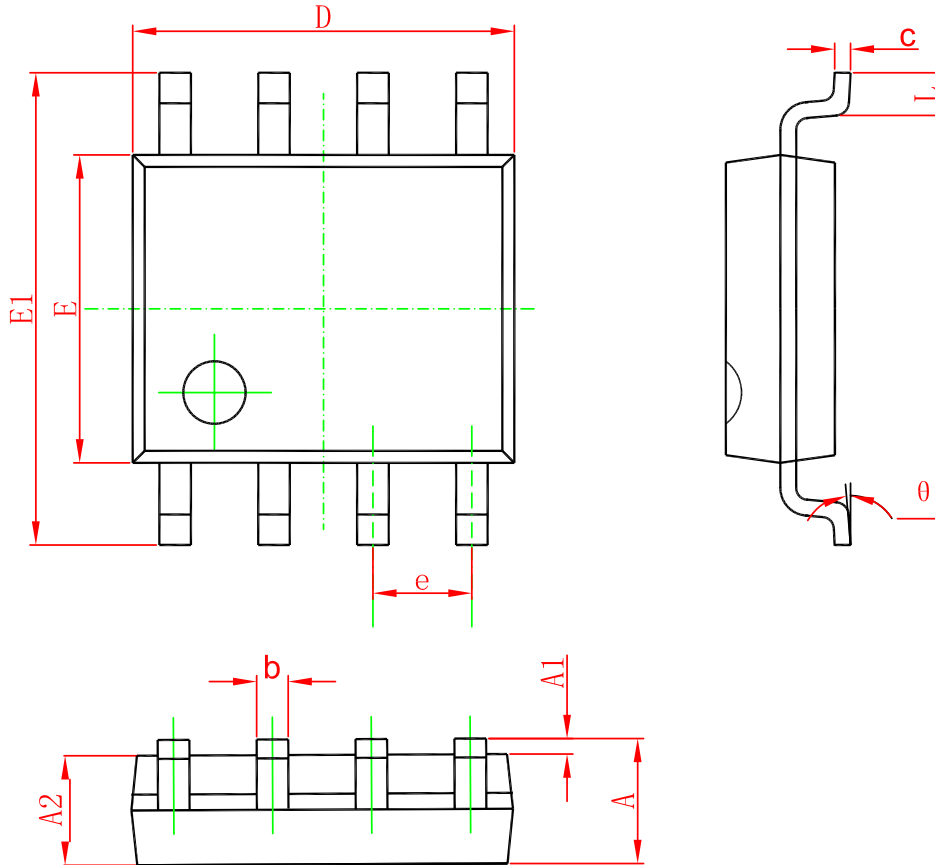

Figure 24. Turn-off time, $V_{CC} = 5\text{ V}$, V_{out} pulled down, $T = 25^\circ\text{ C}$



PACKAGING INFORMATION

SOP-8



Symbol	Dimensions In Millimeters		Dimensions In Inches	
	Min	Max	Min	Max
A	1.350	1.750	0.053	0.069
A1	0.100	0.250	0.004	0.010
A2	1.350	1.550	0.053	0.061
b	0.330	0.510	0.013	0.020
c	0.170	0.250	0.006	0.010
D	4.700	5.100	0.185	0.200
E	3.800	4.000	0.150	0.157
E1	5.800	6.200	0.228	0.244
e	1.270(BSC)		0.050(BSC)	
L	0.400	1.270	0.016	0.050
θ	0°	8°	0°	8°

TSSOP-14

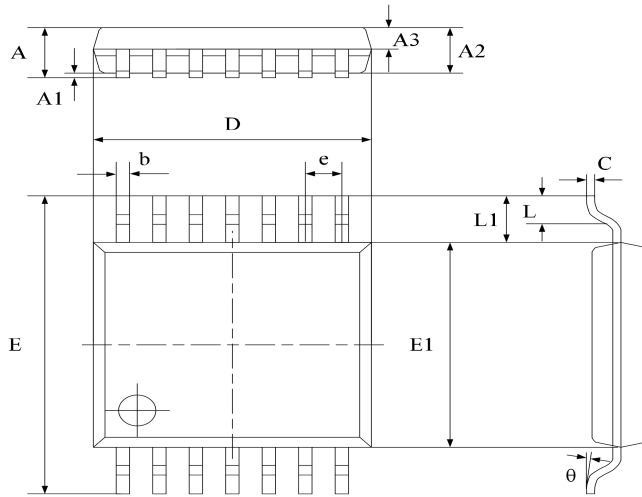

Symbol	Dimensions In Millimeters		Dimensions In Inches	
	Min	Max	Min	Max
A	-	1.200	-	0.0472
A1	0.050	0.150	0.002	0.006
A2	0.900	1.050	0.037	0.043
A3	0.390	0.490	0.016	0.020
b	0.200	0.290	0.008	0.012
C	0.130	0.180	0.005	0.007
D	4.860	5.060	0.198	0.207
E	6.200	6.600	0.253	0.269
E1	4.300	4.500	0.176	0.184
e	0.650 typ.		0.0256 typ.	
L1	1.000 ref.		0.0393 ref.	
L	0.450	0.750	0.018	0.031
θ	0°	8°	0°	8°

Ordering information

Order code	Package	Baseqty	Deliverymode	Marking
UMW TSV6292IDT	SOP-8	2500	Tape and reel	V6292I
UMW TSV6292AIDT	SOP-8	2500	Tape and reel	V6292AI
UMW TSV6294AIPT	TSSOP-14	4000	Tape and reel	TSV6294
UMW TSV6294IPT	TSSOP-14	4000	Tape and reel	TSV6294