

GENERAL DESCRIPTION

The AD8531, AD8532, and AD8534 are single, dual, and quad rail-to-rail input/output single-supply amplifiers featuring 250 mA output drive current. This high output current makes these amplifiers excellent for driving either resistive or capacitive loads. AC performance is very good with 3 MHz bandwidth, 5 V/ μ s slew rate, and low distortion. All are guaranteed to operate from a 3 V single supply as well as a 5 V supply.

The very low input bias currents enable the AD853x to be used for integrators, diode amplification, and other applications requiring low input bias current. Supply current is only 750 μ A per amplifier at 5 V, allowing low current applications to control high current loads.

Applications include audio amplification for computers, sound ports, sound cards, and set-top boxes. The AD853x family is very stable, and it is capable of driving heavy capacitive loads such as those found in LCDs.

The ability to swing rail-to-rail at the inputs and outputs enables designers to buffer CMOS DACs, ASICs, or other wide output swing devices in single-supply systems.

FEATURES

- Single-supply operation: 2.7 V to 6 V
- High output current: \pm 250 mA
- Low supply current: 750 μ A/amplifier
- Wide bandwidth: 3 MHz
- Slew rate: 5 V/ μ s
- No phase reversal
- Low input currents
- Unity gain stable
- Rail-to-rail input and output

APPLICATIONS

- Multimedia audio
- LCD drivers
- ASIC input or output amplifiers
- Headphone drivers

PIN CONFIGURATIONS

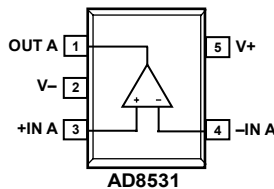

Figure 1. 5-Lead SC70 and 5-Lead SOT-23 (KS and RT Suffixes)

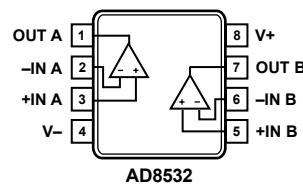
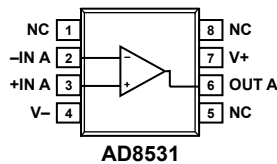

Figure 3. 8-Lead SOP 8-Lead TSSOP (R, RU, and RM Suffixes)



NC = NO CONNECT

Figure 2. 8-Lead SOP (R Suffix)

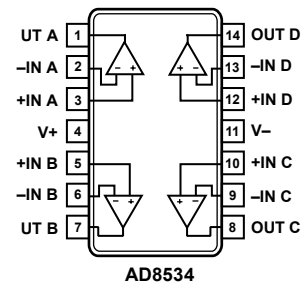

Figure 4. 14-Lead SOP and 14-Lead TSSOP (R and RU Suffixes)

SPECIFICATIONS

ELECTRICAL CHARACTERISTICS

$V_S = 3.0\text{ V}$, $V_{CM} = 1.5\text{ V}$, $T_A = 25^\circ\text{C}$, unless otherwise noted.

Parameter	Symbol	Conditions	Min	Typ	Max	Unit
Offset Voltage	V_{OS}				25	mV
		$-40^\circ\text{C} \leq T_A \leq +85^\circ\text{C}$			30	mV
Input Bias Current	I_B			5	50	pA
		$-40^\circ\text{C} \leq T_A \leq +85^\circ\text{C}$			60	pA
Input Offset Current	I_{OS}			1	25	pA
		$-40^\circ\text{C} \leq T_A \leq +85^\circ\text{C}$			30	pA
Input Voltage Range			0		3	V
Common-Mode Rejection Ratio	CMRR	$V_{CM} = 0\text{ V to }3\text{ V}$	38	45		dB
Large Signal Voltage Gain	A_{VO}	$R_L = 2\text{ k}\Omega$, $V_O = 0.5\text{ V to }2.5\text{ V}$		25		V/mV
Offset Voltage Drift	$\Delta V_{OS}/\Delta T$			20		$\mu\text{V}/^\circ\text{C}$
Bias Current Drift	$\Delta I_B/\Delta T$			50		fA/ $^\circ\text{C}$
Offset Current Drift	$\Delta I_{OS}/\Delta T$			20		fA/ $^\circ\text{C}$
Output Voltage High	V_{OH}	$I_L = 10\text{ mA}$	2.85	2.92		V
		$-40^\circ\text{C} \leq T_A \leq +85^\circ\text{C}$	2.8			V
Output Voltage Low	V_{OL}	$I_L = 10\text{ mA}$		60	100	mV
		$-40^\circ\text{C} \leq T_A \leq +85^\circ\text{C}$			125	mV
Output Current	I_{OUT}			± 250		mA
Closed-Loop Output Impedance	Z_{OUT}	$f = 1\text{ MHz}$, $A_V = 1$		60		Ω
Power Supply Rejection Ratio	PSRR	$V_S = 3\text{ V to }6\text{ V}$	45	55		dB
Supply Current/Amplifier	I_{SY}	$V_O = 0\text{ V}$		0.70	1	mA
		$-40^\circ\text{C} \leq T_A \leq +85^\circ\text{C}$			1.25	mA
Slew Rate	SR	$R_L = 2\text{ k}\Omega$		3.5		V/ μs
Settling Time	t_s	To 0.01%		1.6		μs
Gain Bandwidth Product	GBP			2.2		MHz
Phase Margin	ϕ_o			70		Degrees
Channel Separation	CS	$f = 1\text{ kHz}$, $R_L = 2\text{ k}\Omega$		65		dB
Voltage Noise Density	e_n	$f = 1\text{ kHz}$		45		nV/ $\sqrt{\text{Hz}}$
		$f = 10\text{ kHz}$		30		nV/ $\sqrt{\text{Hz}}$
Current Noise Density	i_n	$f = 1\text{ kHz}$		0.05		pA/ $\sqrt{\text{Hz}}$

$V_S = 5.0\text{ V}$, $V_{CM} = 2.5\text{ V}$, $T_A = 25^\circ\text{C}$, unless otherwise noted.

Parameter	Symbol	Conditions	Min	Typ	Max	Unit
Offset Voltage	V_{OS}				25	mV
		$-40^\circ\text{C} \leq T_A \leq +85^\circ\text{C}$			30	mV
Input Bias Current	I_B			5	50	pA
		$-40^\circ\text{C} \leq T_A \leq +85^\circ\text{C}$			60	pA
Input Offset Current	I_{OS}			1	25	pA
		$-40^\circ\text{C} \leq T_A \leq +85^\circ\text{C}$			30	pA
Input Voltage Range			0		5	V
Common-Mode Rejection Ratio	CMRR	$V_{CM} = 0\text{ V to }5\text{ V}$	38	47		dB
Large Signal Voltage Gain	A_{VO}	$R_L = 2\text{ k}\Omega$, $V_O = 0.5\text{ V to }4.5\text{ V}$	15	80		V/mV
Offset Voltage Drift	$\Delta V_{OS}/\Delta T$	$-40^\circ\text{C} \leq T_A \leq +85^\circ\text{C}$		20		$\mu\text{V}/^\circ\text{C}$
Bias Current Drift	$\Delta I_B/\Delta T$			50		fA/ $^\circ\text{C}$
Offset Current Drift	$\Delta I_{OS}/\Delta T$			20		fA/ $^\circ\text{C}$
Output Voltage High	V_{OH}	$I_L = 10\text{ mA}$	4.9	4.94		V
		$-40^\circ\text{C} \leq T_A \leq +85^\circ\text{C}$	4.85			V
Output Voltage Low	V_{OL}	$I_L = 10\text{ mA}$		50	100	mV
		$-40^\circ\text{C} \leq T_A \leq +85^\circ\text{C}$			125	mV
Output Current	I_{OUT}			± 250		mA
Closed-Loop Output Impedance	Z_{OUT}	$f = 1\text{ MHz}$, $A_V = 1$		40		Ω
Power Supply Rejection Ratio	PSRR	$V_S = 3\text{ V to }6\text{ V}$	45	55		dB
Supply Current/Amplifier	I_{SY}	$V_O = 0\text{ V}$		0.75	1.25	mA
		$-40^\circ\text{C} \leq T_A \leq +85^\circ\text{C}$			1.75	mA
Slew Rate	SR	$R_L = 2\text{ k}\Omega$		5		V/ μs
Full-Power Bandwidth	BW_p	1% distortion		350		kHz
Settling Time	t_s	To 0.01%		1.4		μs
Gain Bandwidth Product	GBP			3		MHz
Phase Margin	ϕ_o			70		Degrees
Channel Separation	CS	$f = 1\text{ kHz}$, $R_L = 2\text{ k}\Omega$		65		dB
Voltage Noise Density	e_n	$f = 1\text{ kHz}$		45		nV/ $\sqrt{\text{Hz}}$
		$f = 10\text{ kHz}$		30		nV/ $\sqrt{\text{Hz}}$
Current Noise Density	i_n	$f = 1\text{ kHz}$		0.05		pA/ $\sqrt{\text{Hz}}$

ABSOLUTE MAXIMUM RATINGS

Parameter	Rating
Supply Voltage (V_s)	7 V
Input Voltage	GND to V_s
Differential Input Voltage ¹	± 6 V
Storage Temperature Range	-65°C to $+150^\circ\text{C}$
Operating Temperature Range	-40°C to $+85^\circ\text{C}$
Junction Temperature Range	-65°C to $+150^\circ\text{C}$
Lead Temperature (Soldering, 60 sec)	300°C

¹For supplies less than 6 V, the differential input voltage is equal to $\pm V$

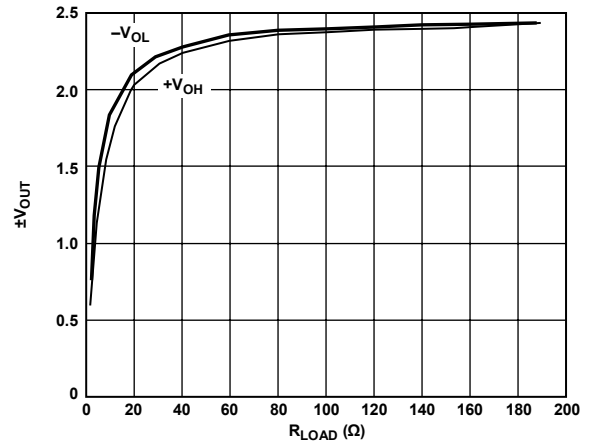

Figure 5. Output Voltage vs. Load, $V_s = \pm 2.5$ V, R_{LOAD} Is Connected to GND (0 V)

TYPICAL PERFORMANCE CHARACTERISTICS

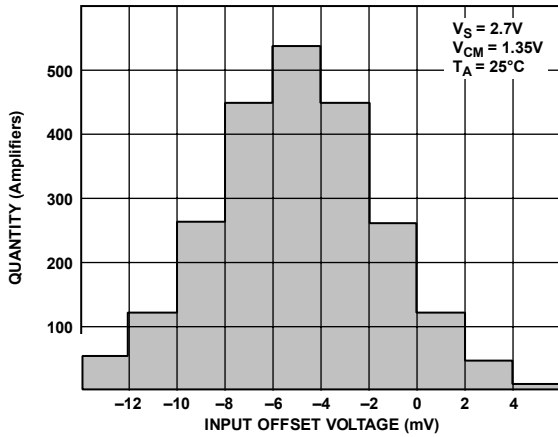

Figure 6. Input Offset Voltage Distribution

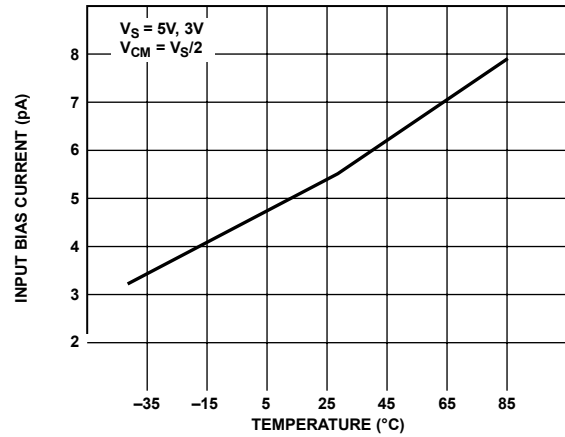

Figure 9. Input Bias Current vs. Temperature

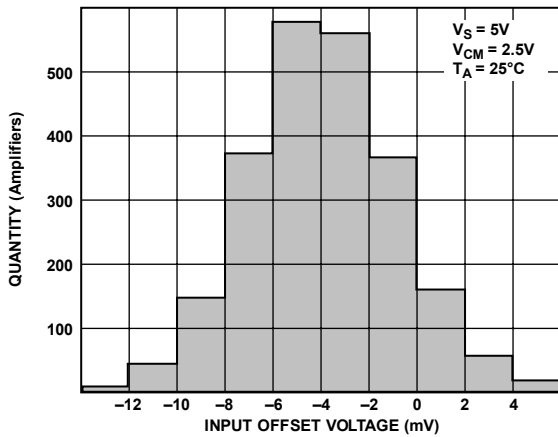

Figure 7. Input Offset Voltage Distribution

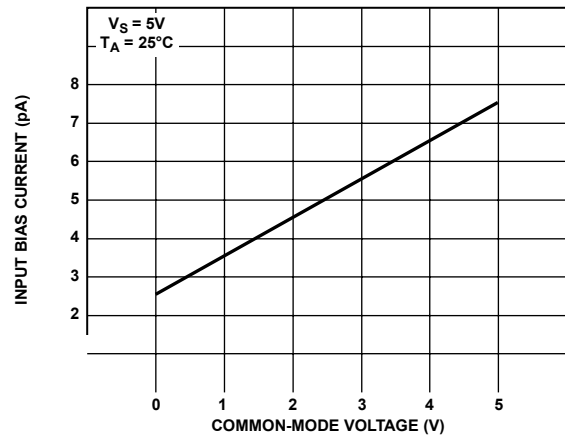

Figure 10. Input Bias Current vs. Common-Mode Voltage

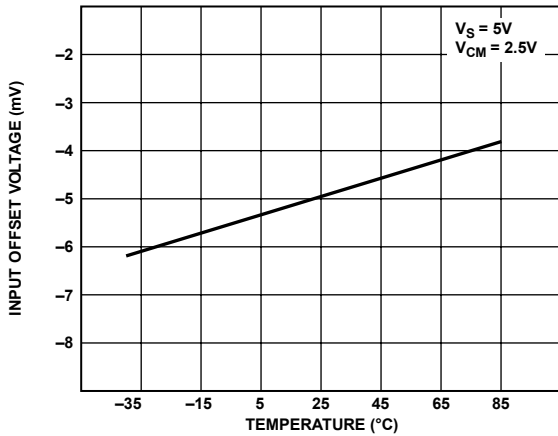

Figure 8. Input Offset Voltage vs. Temperature

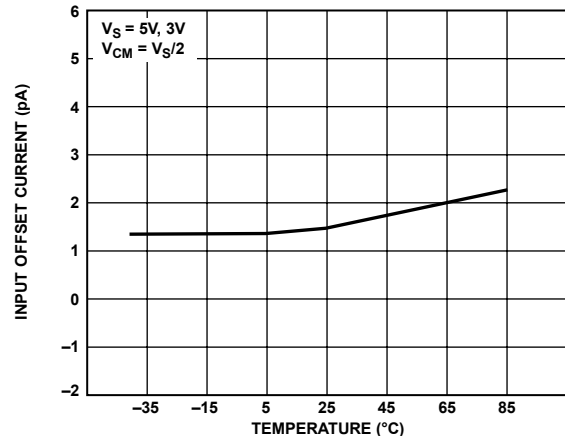

Figure 11. Input Offset Current vs. Temperature

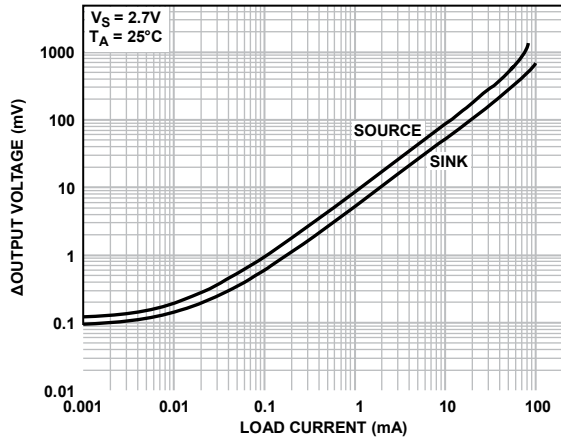

Figure 12. Output Voltage to Supply Rail vs. Load Current

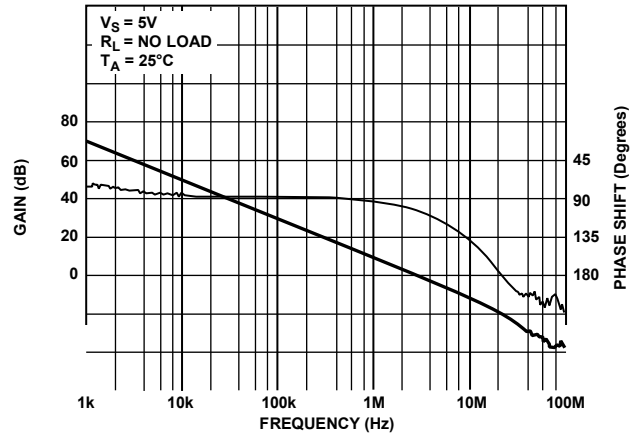

Figure 15. Open-Loop Gain and Phase Shift vs. Frequency

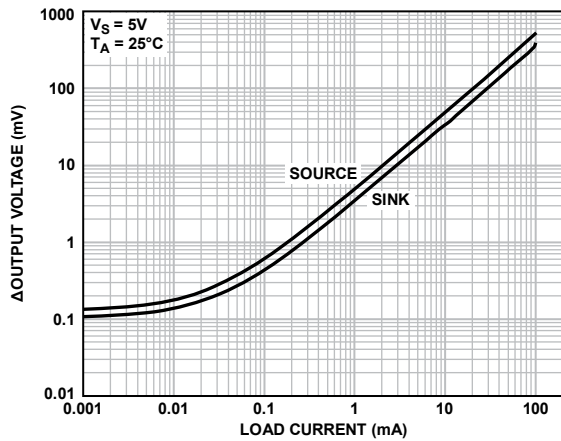

Figure 13. Output Voltage to Supply Rail vs. Load Current

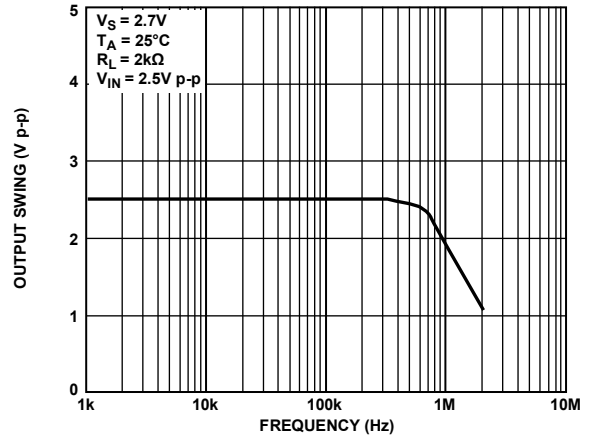

Figure 16. Closed-Loop Output Swing vs. Frequency

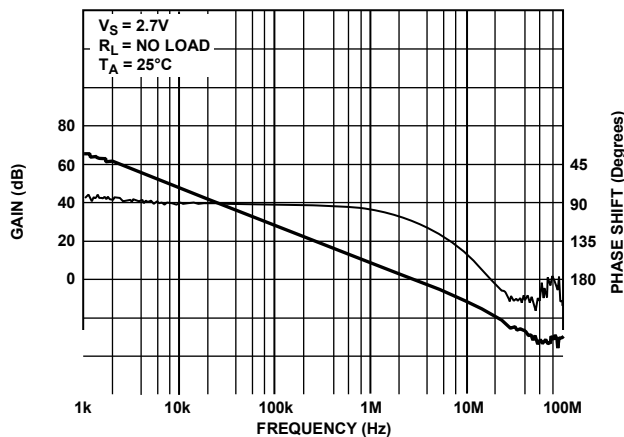

Figure 14. Open-Loop Gain and Phase Shift vs. Frequency

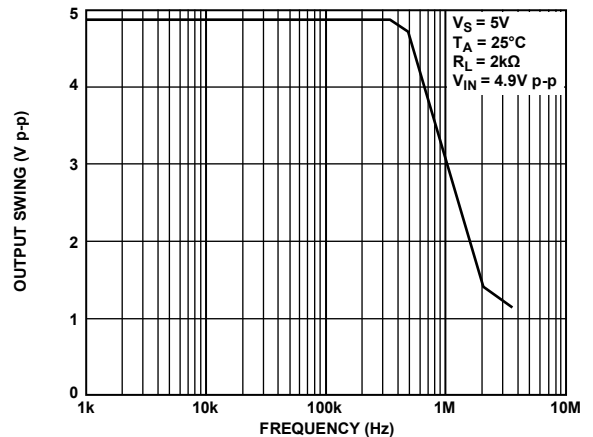

Figure 17. Closed-Loop Output Swing vs. Frequency

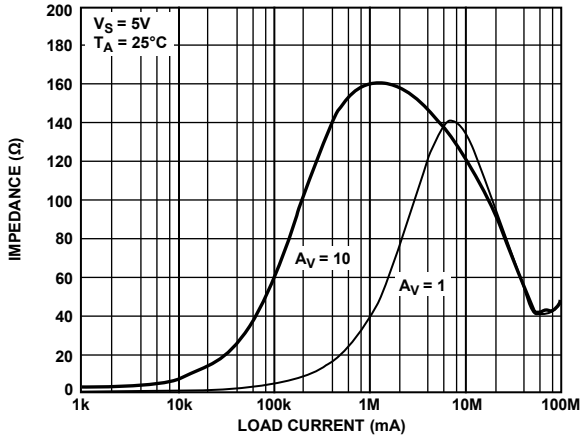

Figure 18. Closed-Loop Output Impedance vs. Frequency

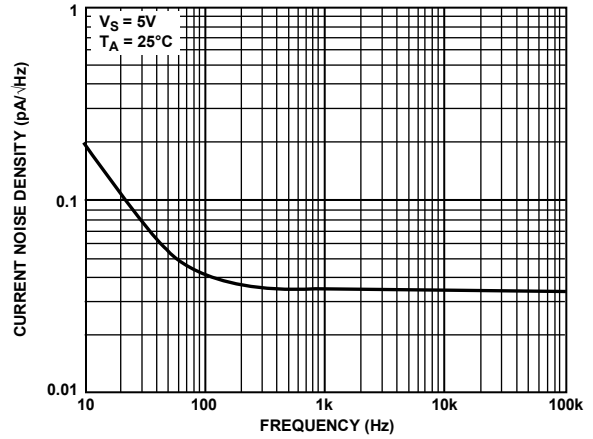

Figure 21. Current Noise Density vs. Frequency

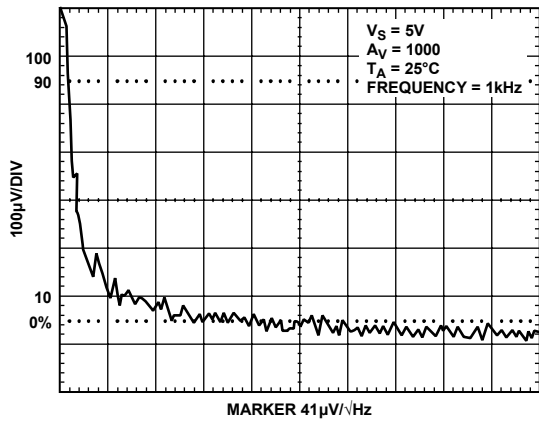

Figure 19. Voltage Noise Density vs. Frequency (1 kHz)

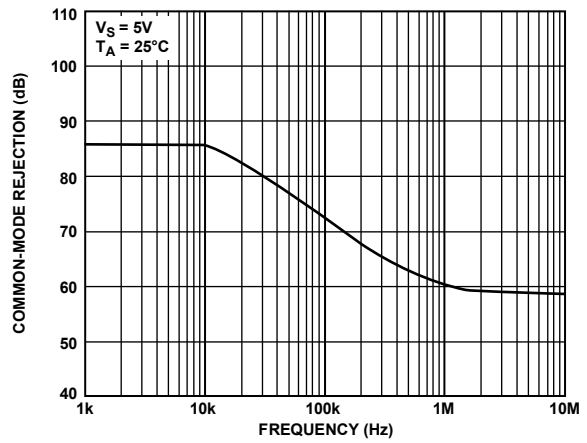

Figure 22. Common-Mode Rejection vs. Frequency

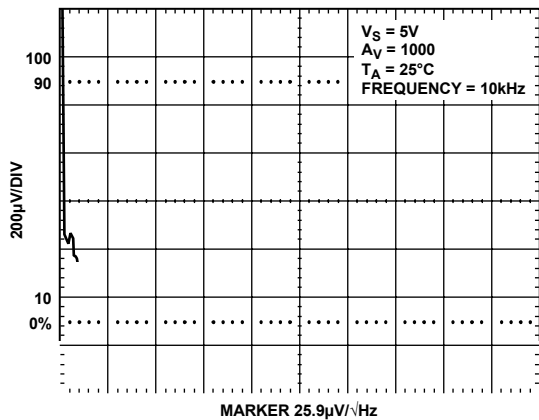

Figure 20. Voltage Noise Density vs. Frequency (10 kHz)

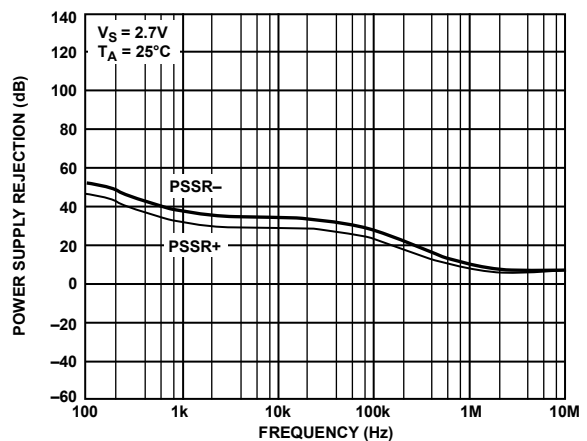

Figure 23. Power Supply Rejection vs. Frequency

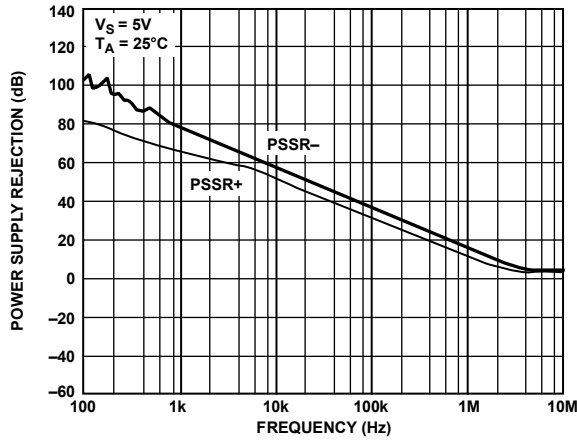

Figure 24. Power Supply Rejection vs. Frequency

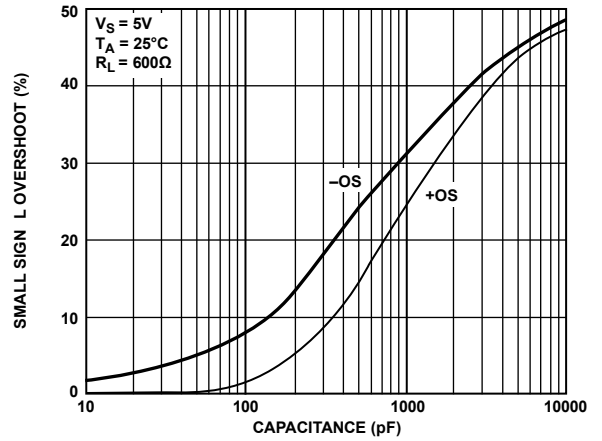

Figure 27. Small Signal Overshoot vs. Load Capacitance

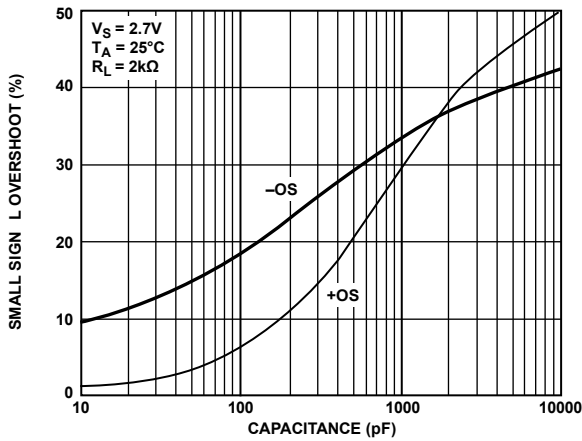

Figure 25. Small Signal Overshoot vs. Load Capacitance

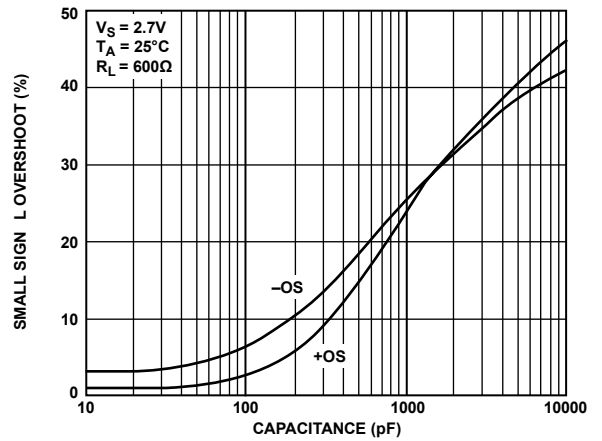

Figure 28. Small Signal Overshoot vs. Load Capacitance

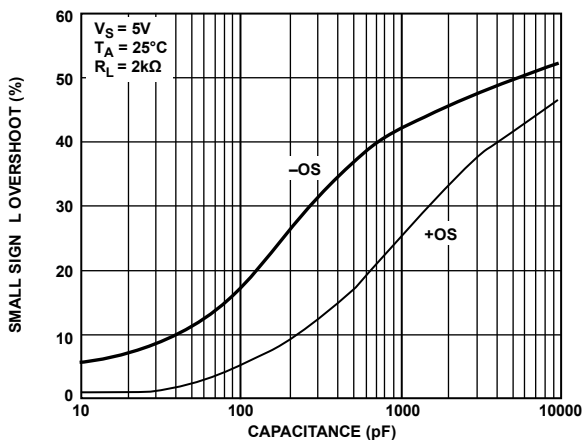

Figure 26. Small Signal Overshoot vs. Load Capacitance

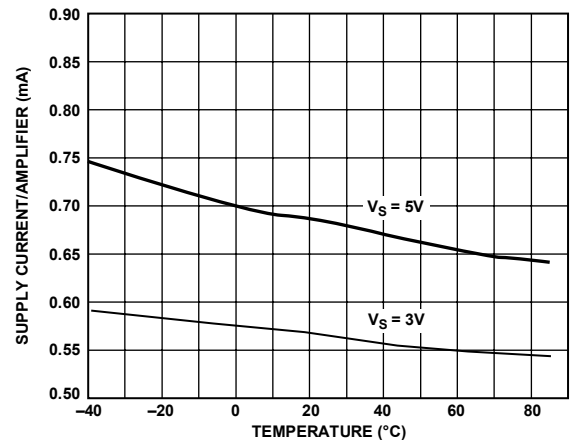

Figure 29. Supply Current per Amplifier vs. Temperature

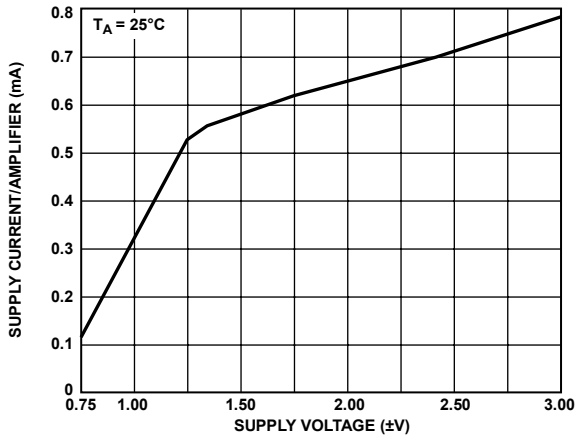

Figure 30. Supply Current per Amplifier vs. Supply Voltage

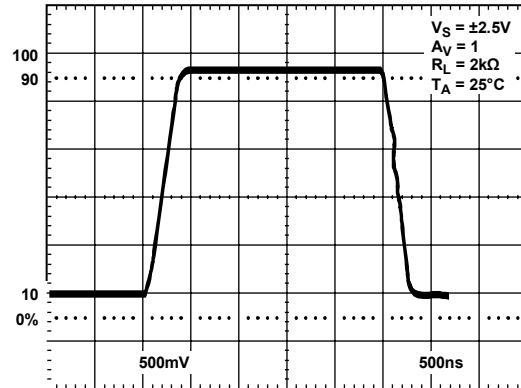

Figure 33. Large Signal Transient Response

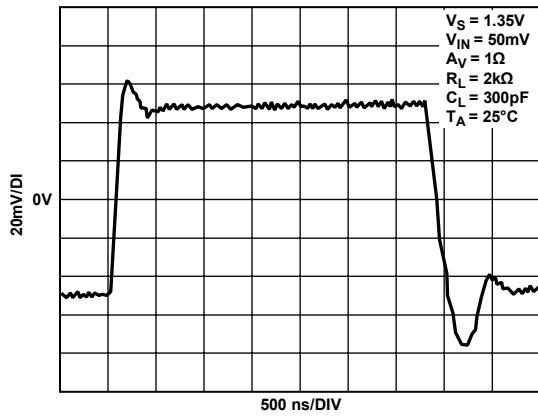

Figure 31. Small Signal Transient Response

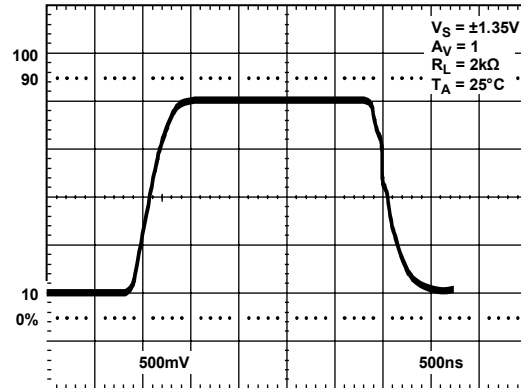

Figure 34. Large Signal Transient Response

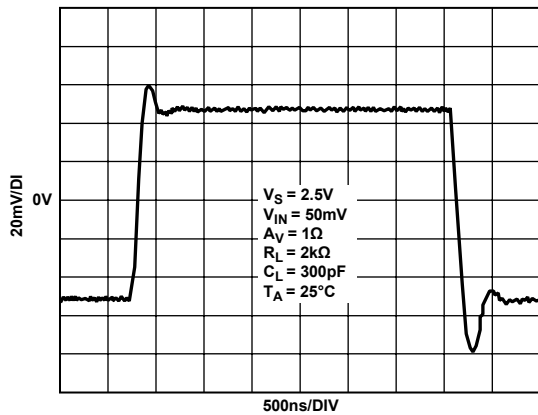

Figure 32. Small Signal Transient Response

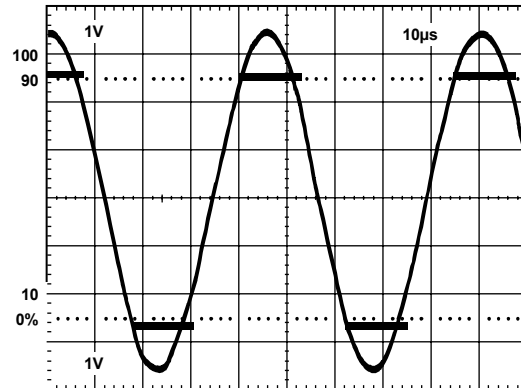
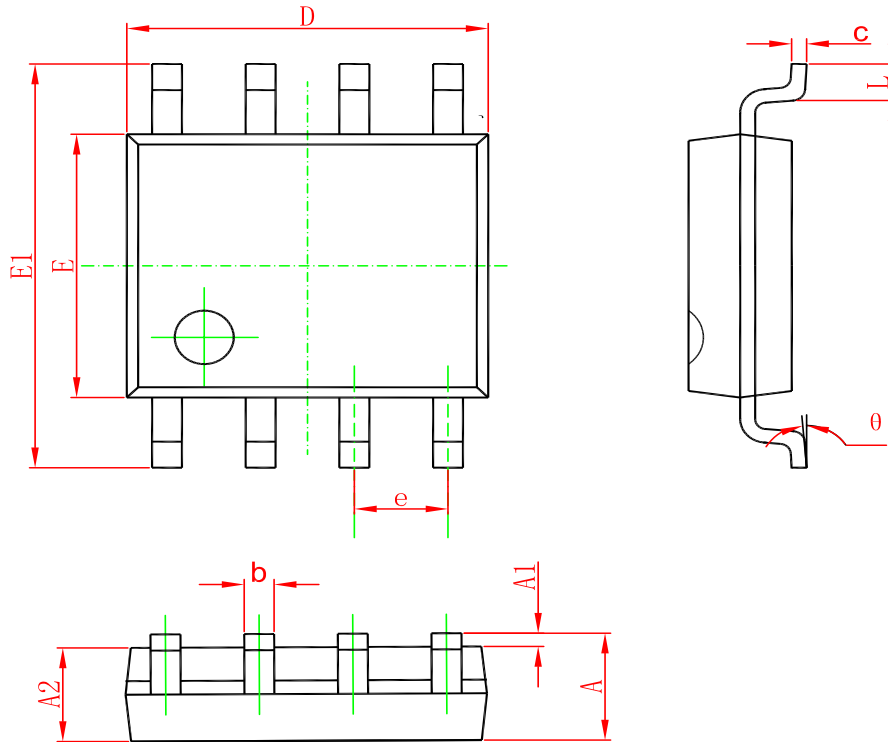

Figure 35. No Phase Reversal

Package Dimension

SOP-8



Symbol	Dimensions In Millimeters		Dimensions In Inches	
	Min	Max	Min	Max
A	1.350	1.750	0.053	0.069
A1	0.100	0.250	0.004	0.010
A2	1.350	1.550	0.053	0.061
b	0.330	0.510	0.013	0.020
c	0.170	0.250	0.006	0.010
D	4.700	5.100	0.185	0.200
E	3.800	4.000	0.150	0.157
E1	5.800	6.200	0.228	0.244
e	1.270(BSC)		0.050(BSC)	
L	0.400	1.270	0.016	0.050
θ	0°	8°	0°	8°

SC70-5 (SOT353)

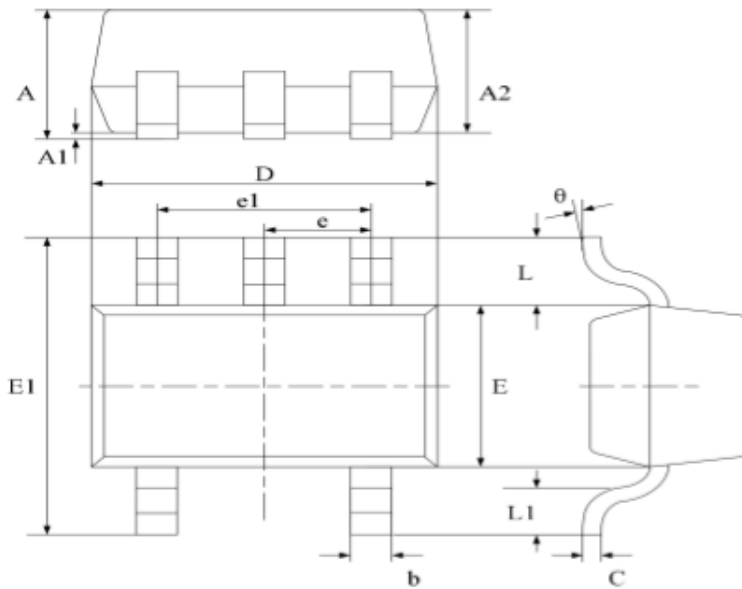

Symbol	Dimensions In Millimeters		Dimensions In Inches	
	Min	Max	Min	Max
A	0.800	1.100	0.035	0.043
A1	0.000	0.100	0.000	0.004
A2	0.800	0.900	0.035	0.039
b	0.150	0.350	0.006	0.014
C	0.080	0.150	0.003	0.006
D	1.8500	2.150	0.079	0.087
E	1.100	1.400	0.045	0.053
E1	1.950	2.200	0.085	0.096
e	0.850 typ.		0.026 typ.	
e1	1.200	1.400	0.047	0.055
L	0.42 ref.		0.021 ref.	
L1	0.260	0.460	0.010	0.018
θ	0°	8°	0°	8°

SOT23-5

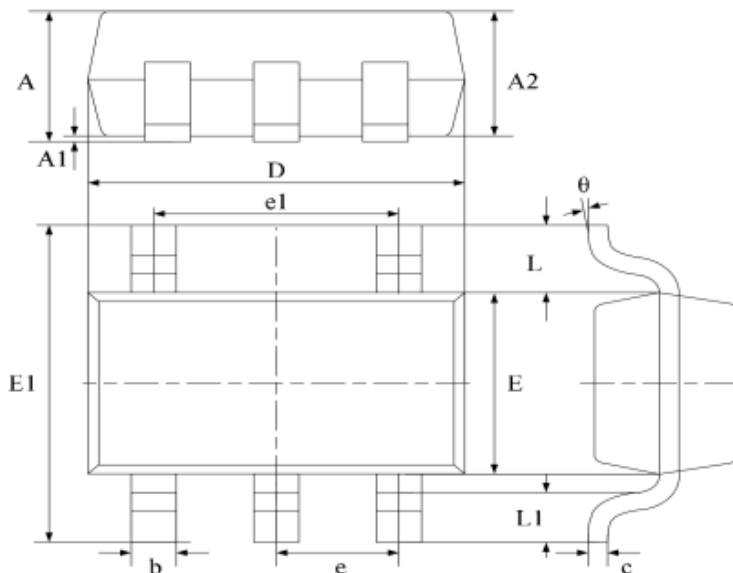

Symbol	Dimensions In Millimeters		Dimensions In Inches	
	Min	Max	Min	Max
A	1.040	1.350	0.042	0.055
A1	0.040	0.150	0.002	0.006
A2	1.000	1.200	0.041	0.049
b	0.380	0.480	0.015	0.020
c	0.110	0.210	0.004	0.009
D	2.720	3.120	0.111	0.127
E	1.400	1.800	0.057	0.073
E1	2.600	3.000	0.106	0.122
e	0.950 typ.		0.037 typ.	
e1	1.900 typ.		0.078 typ.	
L	0.700 ref.		0.028 ref.	
L1	0.300	0.600	0.012	0.024
θ	0°	8°	0°	8°

TSSOP-8

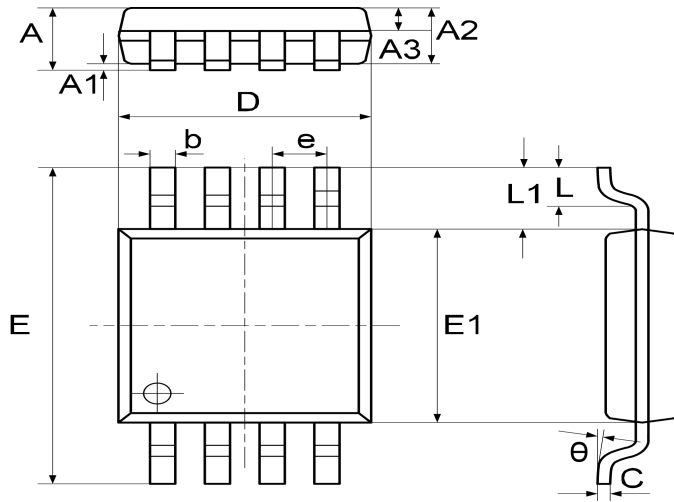

Symbol	Dimensions In Millimeters		
	Min	Nom	Max
A	-	-	1.200
A1	0.050	-	0.150
A2	0.900	1.000	1.050
A3	0.390	0.440	0.490
b	0.200	-	0.280
C	0.130	-	0.170
D	2.900	3.000	3.100
E	6.200	6.400	6.600
E1	4.300	4.400	4.500
e	0.65BSC		
L	0.450	-	0.750
L1	1.000 ref		
θ	0°	-	8°

Ordering information

Order code	Package	Baseqty	Deliverymode	Marking
UMW AD8534ARZ	SOP-14	2500	Tape and reel	AD8534
UMW AD8532ARZ	SOP-8	2500	Tape and reel	AD8532
UMW AD8531ARZ	SOP-8	2500	Tape and reel	AD8531
UMW AD8531ARTZ	SOT23-5	3000	Tape and reel	A0P U
UMW AD8534ARUZ	TSSOP-14	4000	Tape and reel	AD8534
UMW AD8532ARUZ	TSSOP-8	4000	Tape and reel	AD8532
UMW AD8531AKSZ	SC70-5	3000	Tape and reel	A0Q U