

REV.	DESCRIPTION	DESIGN	APPROVAL	DATE
A0	NEW VERSION	Colinye	Jerry	

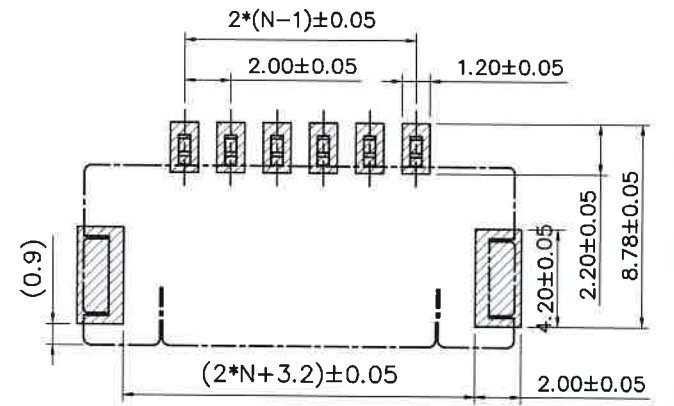

P.C.B LAYOUT

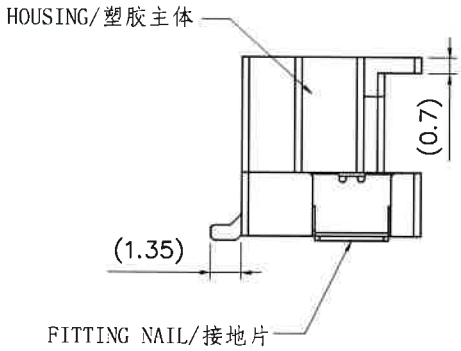
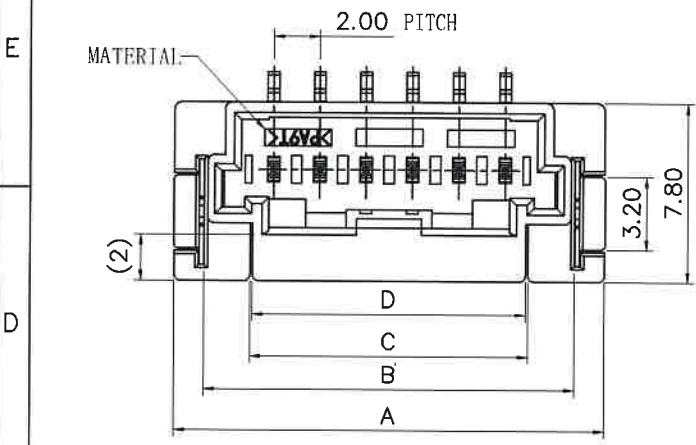
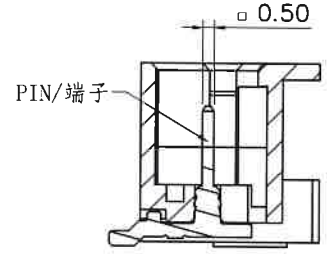
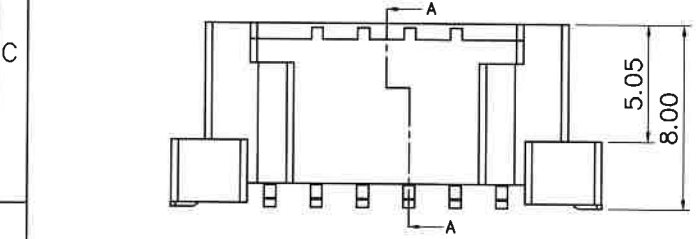

SECT: A-A

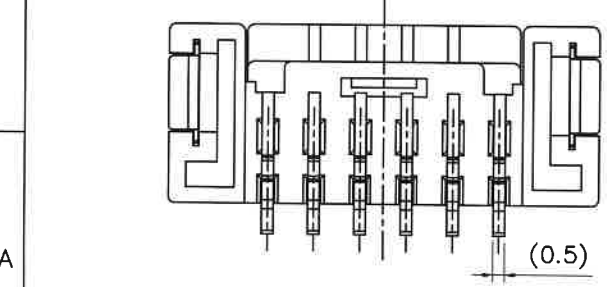

Part No.	Circuits	DIM(mm)			
		A	B	C	D
991-021-7007	02	10.9	8.0	/	6.3
991-031-7007	03	12.6	9.7	6	5.8
991-041-7007	04	14.6	11.7	8	7.8
991-051-7007	05	16.6	13.7	10	9.8
991-061-7007	06	18.6	15.7	12	11.8
991-071-7007	07	20.6	17.7	13.1	
991-081-7007	08	22.6	19.7	15.1	
991-091-7007	09	24.6	21.7	17.1	
991-101-7007	10	26.6	23.7	19.1	
991-111-7007	11	28.6	25.7	21.1	
991-121-7007	12	30.6	27.7	23.1	
991-131-7007	13	32.6	29.7	25.1	
991-141-7007	14	34.6	31.7	27.1	
991-151-7007	15	36.6	33.7	29.1	

广东济德精密电子有限公司
受控文件
 日期: 2021年10月18日

X.± 0.35	X.*± 1*
.X± 0.30	.X*± 0.5*
.XX± 0.20	.XX*± /
.XXX± 0.10	.XXX*± /
UNITS:	mm

JIDC Guangdong JiDe Precision Electronics Co., Ltd
 广东济德精密电子有限公司

The information in this document is property of JIDC company and should not be copied or reproduced in any other way, without written permission.

TITLE: 2.0mm Pitch wafer 180° Type	PART NO. 991-XX1-7007						
APPD: <i>Jerry</i>	DWG NO: C-991-XX1-7007						
CHKD: <i>Ray</i>	<table border="1"> <tr> <td>SCALE</td> <td>SHEET</td> <td>REV.</td> </tr> <tr> <td>N/A</td> <td>1/2</td> <td>A0</td> </tr> </table>	SCALE	SHEET	REV.	N/A	1/2	A0
SCALE		SHEET	REV.				
N/A	1/2	A0					
DRAW: <i>Colinye</i>							

REV.	DESCRIPTION	DESIGN	APPROVAL	DATE
A0	NEW VERSION	Colinye	Jerry	

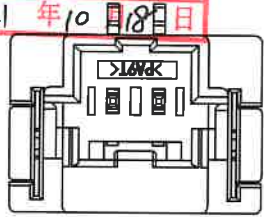

2CKTS

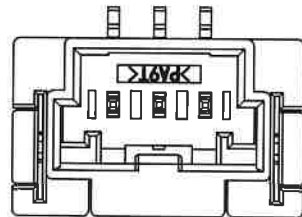

3CKTS

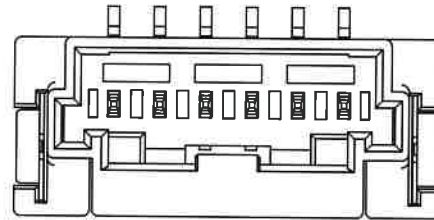

6CKTS

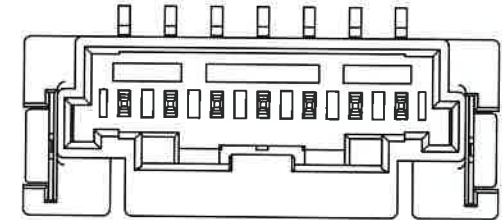

7-15CKTS

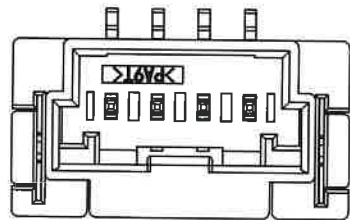
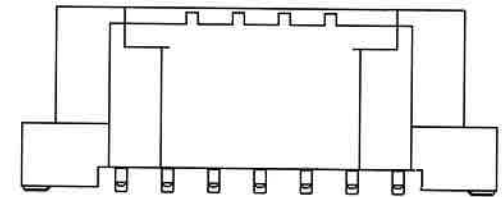
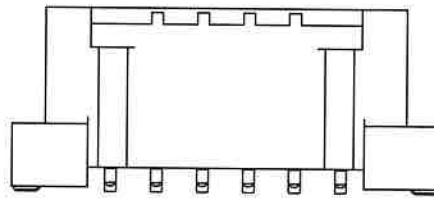
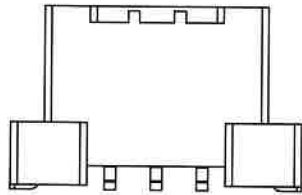
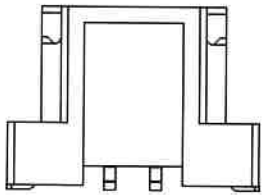

4CKTS

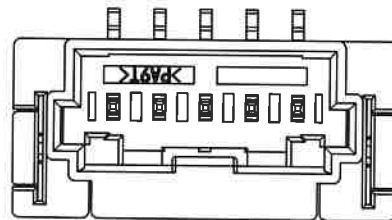

5CKTS

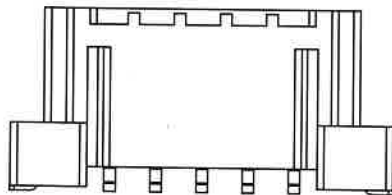
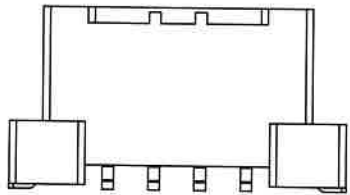

NOTES:

1. Material/材质:

Housing/主体: PA9T UL94V-0, Color/颜色: Natural/本色

Pin/端子: Copper Alloy/铜合金, Tin-Plated/镀锡

Flnting Nail/接地片: Copper Alloy/铜合金, Tin-Plated/镀锡

2. The surface of the product shall be free of excessive plastic, lack of plastic, mottle, etc

产品表面不能有多胶、缺胶、杂色等现象

3. Harmful material please follow RoHS

产品需符合RoHS标准.

4. ORDER INFORMATION/编码原则: 991- XX 1-7007

Pin NO.: XX-02~15PIN

X.± 0.35	X.*± 1*	Guangdong JiDe Precision Electronics Co., Ltd 广东济德精密电子有限公司	PART NO. 991-XX1-7007		
.X± 0.30	.X*± 0.5*				
.XX± 0.20	.XX*± /		SCALE	SHEET	REV.
.XXX± 0.10	.XXX*± /		N/A	2/2	A0
UNITS: mm		TITLE: 2.0mm Pitch wafer 180° Type	APPD: Jerry CHKD: Ray DRAW: Colinye		
The information in this document is property of JIDC company and should not be copied or reproduced in any other way, without written permission.					