



SMBG Plastic-Encapsulate Diodes

US3A THRU US3M High Efficient Rectifier Diodes

Features

- $I_{F(AV)}$ 3A
- V_{RRM} 50V-1000V
- High surge current capability
- Polarity: Color band denotes cathode

Applications

- Rectifier

Marking

- US3X

X : From A To M

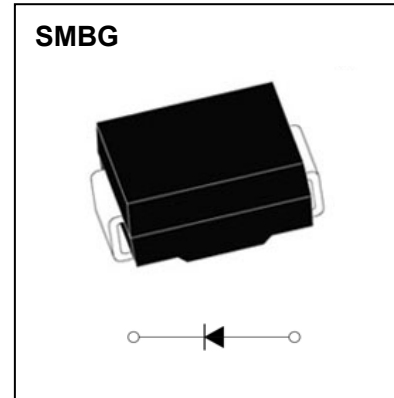

Limiting Values(Absolute Maximum Rating)

Item	Symbol	Unit	Test Conditions	US3						
				A	B	D	G	J	K	M
Repetitive Peak Reverse Voltage	V_{RRM}	V		50	100	200	400	600	800	1000
Maximum RMS Voltage	V_{RMS}	V		35	70	140	280	420	560	700
Average Forward Current	$I_{F(AV)}$	A	60Hz Half-sine wave, Resistance load	3.0						
Surge(Non-repetitive)Forward Current	I_{FSM}	A	60Hz Half-sine wave, 1 cycle, $T_a=25^\circ\text{C}$	100						
Operation Junction and Storage Temperature Range	T_J, T_{STG}	$^\circ\text{C}$		-55 ~ +150						

Electrical Characteristics ($T=25^\circ\text{C}$ Unless otherwise specified)

Item	Symbol	Unit	Test Condition	US3						
				A	B	D	G	J	K	M
Peak Forward Voltage	V_F	V	$I_F=3.0\text{A}$	1.0			1.3	1.7		
Maximum reverse recovery time	t_{rr}	ns	$I_F=0.5\text{A}, I_R=1.0\text{A}, I_{rr}=0.25\text{A}$	50				75		
Peak Reverse Current	I_{RRM1}	μA	$V_{RM}=V_{RRM}$	$T_a=25^\circ\text{C}$						
	I_{RRM2}			$T_a=125^\circ\text{C}$						
Thermal Resistance(Typical)	$R_{\theta J-A}$	$^\circ\text{C/W}$	Between junction and ambient				65			
	$R_{\theta J-L}$		Between junction and terminal				13			
Juction Capacitance (Typical)	C_j	pF	Measured at 1MHZ and Applied Reverse Voltage of 4.0 V.D.C	60			30	23		

Notes:

Thermal resistance from junction to ambient and from junction to lead mounted on FR4 PCB double sided copper mini pad

Typical Characteristics

FIG.1: FORWARD CURRENT DERATING CURVE

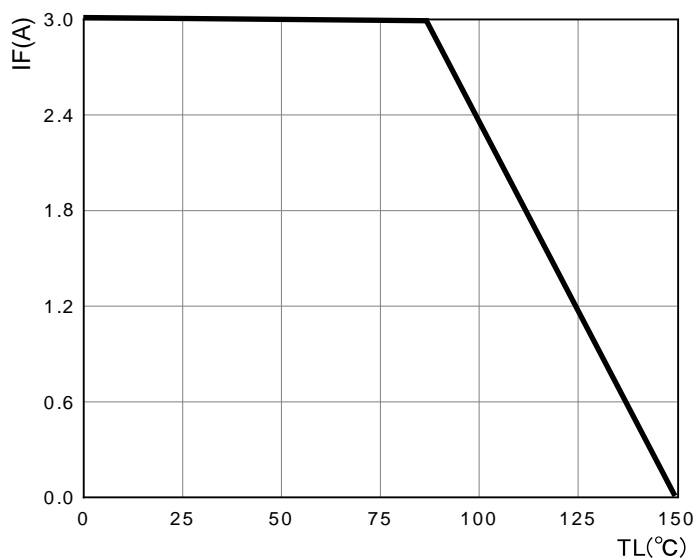
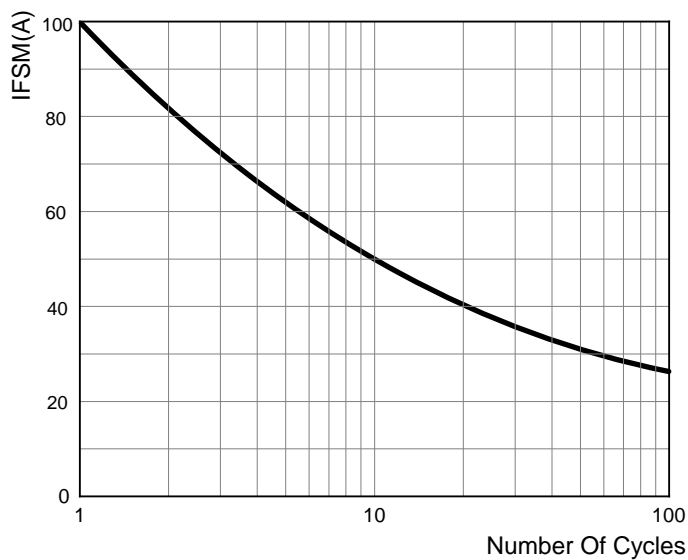
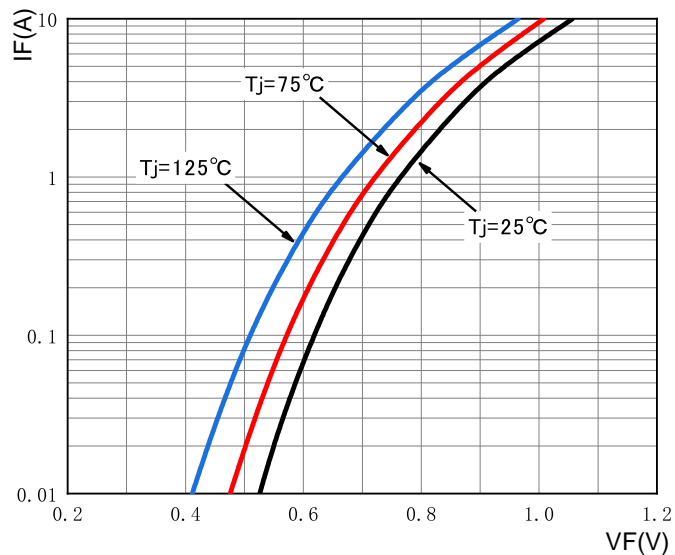

FIG 2: MAXIMUM NON-REPETITIVE FORWARD SURGE CURRENT



US3A-US3D

FIG.3 : TYPICAL FORWARD CHARACTERISTICS



US3A-US3D

FIG.4 TYPICAL REVERSE CHARACTERISTICS

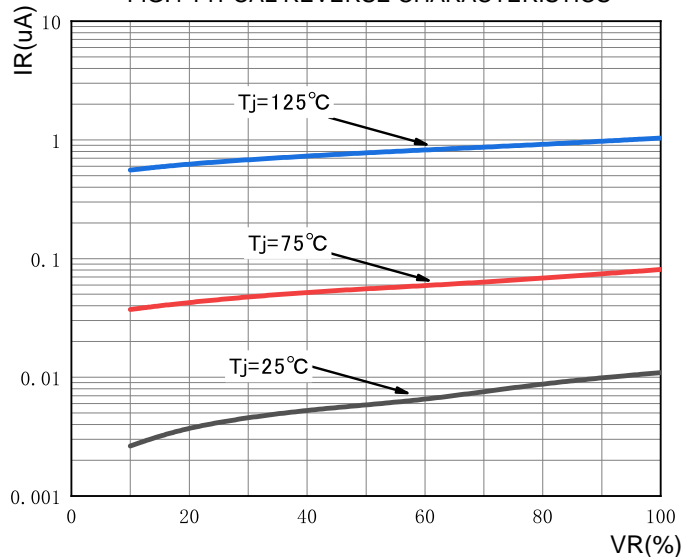

Typical Characteristics

US3G

FIG.5 : TYPICAL FORWARD CHARACTERISTICS

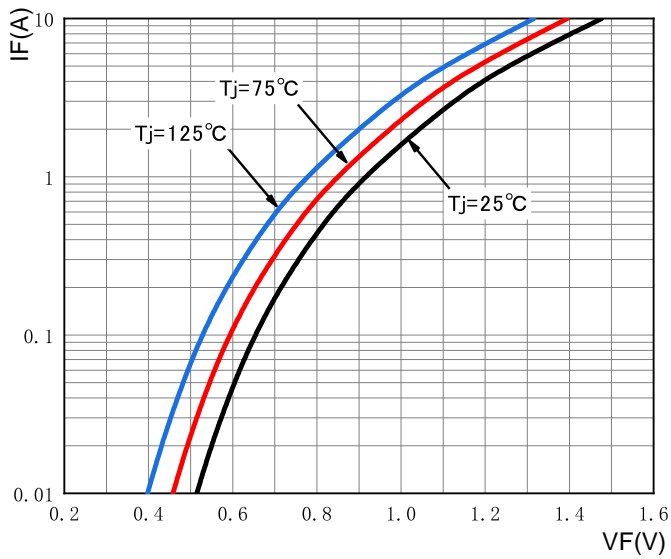

US3G

FIG.6 TYPICAL REVERSE CHARACTERISTICS

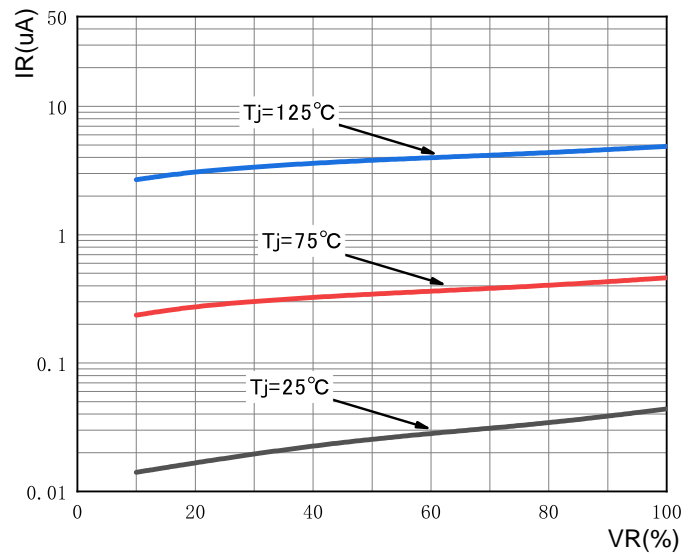

US3J-US3M

FIG.7 : TYPICAL FORWARD CHARACTERISTICS

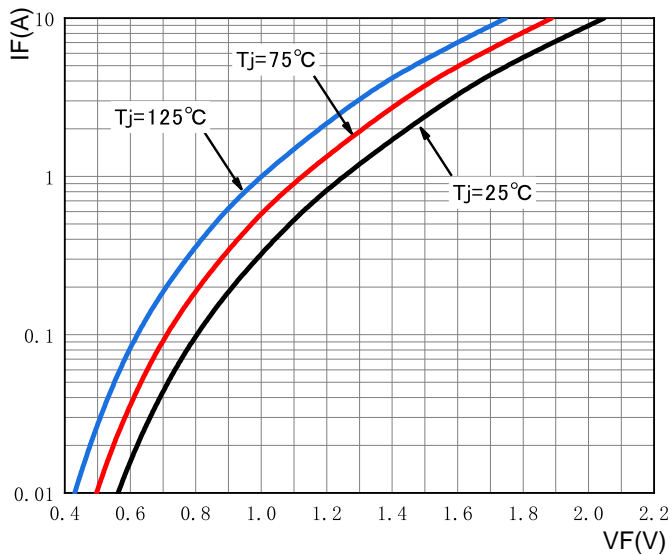

US3J-US3M

FIG.8 TYPICAL REVERSE CHARACTERISTICS

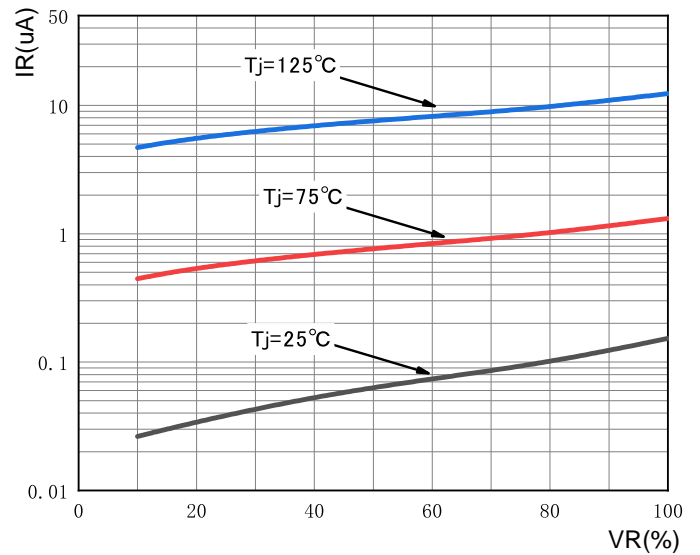

SMBG Package Outline Dimensions

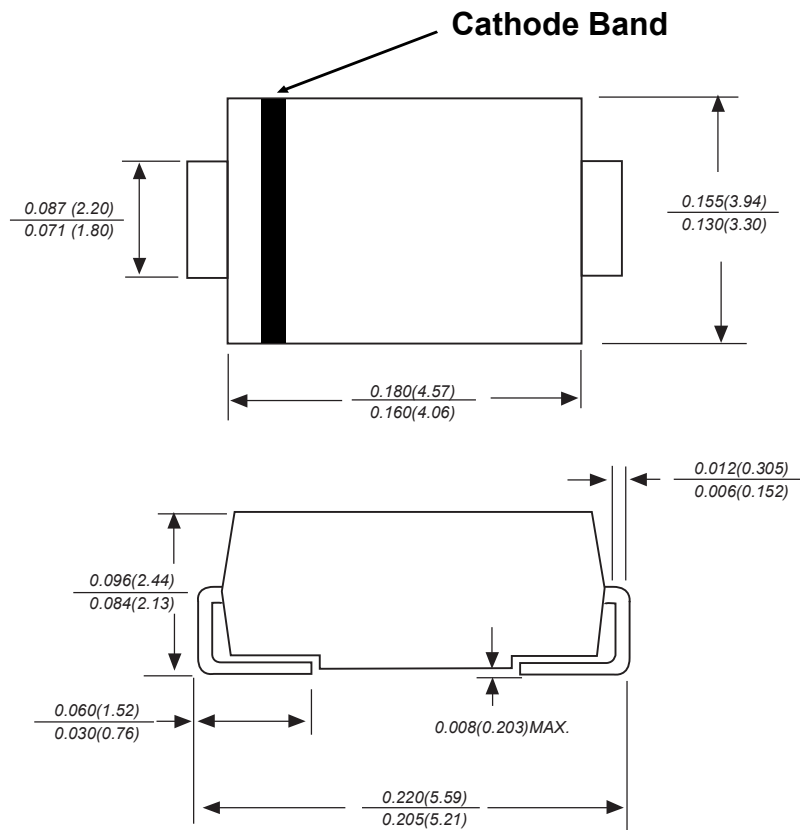

Dimensions in inches and (millimeters)

SMBG Suggested Pad Layout

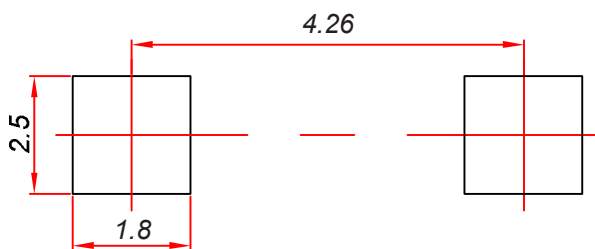

Note:

1. Controlling dimension: in millimeters.
2. General tolerance: ± 0.05 mm.
3. The pad layout is for reference purposes only.

NOTICE

JSCJ reserves the right to make modifications, enhancements, improvements, corrections or other changes without further notice to any product herein. JSCJ does not assume any liability arising out of the application or use of any product described herein.

Reel Taping Specifications For Surface Mount Devices–SMBG

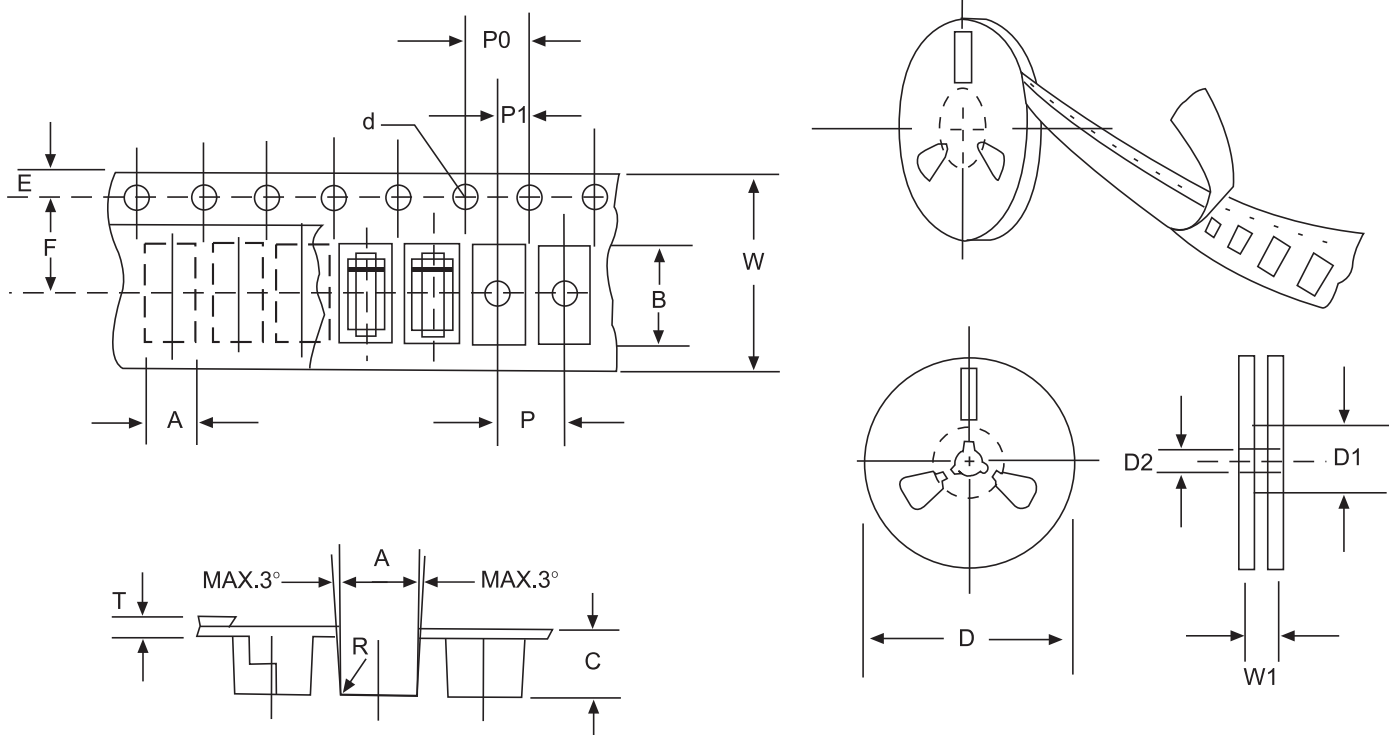

FIG: CONFIGURATION OF SURFACE MOUNTED DEVICES TAPING

ITEM	SYMBOL	SMBG mm(inch)
Carrier width	A	4.09±0.1(0.161±0.004)
Carrier length	B	5.82±0.1(0.229±0.004)
Carrier depth	C	2.50±0.1(0.100±0.004)
Sprocket hole	d	1.55±0.05 (0.061±0.002)
Reel outside diameter	D	330±2.0(13±0.079)
Reel inner diameter	D1	75 ±1.0 (2.95 ±0.039)
Feed hole diameter	D2	13±0.5(0.512±0.020)
Strocket hole position	E	1.75±0.1(0.069±0.004)
Punch hole position	F	5.65±0.05(0.222±0.002)
Punch hole pitch	P	8.0±0.1(0.315±0.004)
Sprocket hole pitch	P0	4.0±0.1(0.157±0.004)
Embossment center	P1	2.0±0.1(0.079±0.004)
Total tape thickness	T	0.32±0.1 (0.013±0.004)
Tape width	W	12.0±0.2(0.472±0.008)
Reel width	W1	16.8±2.0(0.661±0.079)

NOTE: Devices are packed in accordance with EIA standard RS-481-A and specification given above.