



## SMBG Plastic-Encapsulate Diodes

### RS3A THRU RS3M Fast Recovery Rectifier Diodes

#### Features

- $I_{F(AV)}$  3A
- $V_{RRM}$  50V-1000V
- High surge current capability
- Polarity: Color band denotes cathode

#### Applications

- Rectifier

#### Marking

- RS3X

X : From A To M

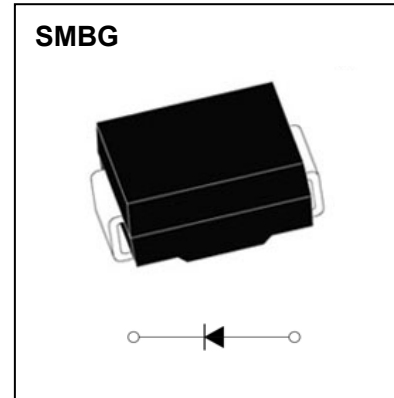

#### Limiting Values(Absolute Maximum Rating)

Item	Symbol	Unit	Test Conditions	RS3						
				A	B	D	G	J	K	M
Repetitive Peak Reverse Voltage	$V_{RRM}$	V		50	100	200	400	600	800	1000
Maximum RMS Voltage	$V_{RMS}$	V		35	70	140	280	420	560	700
Average Forward Current	$I_{F(AV)}$	A	60Hz Half-sine wave, Resistance load	3.0						
Surge(Non-repetitive)Forward Current	$I_{FSM}$	A	60Hz Half-sine wave, 1 cycle, $T_a=25^\circ\text{C}$	100						
Operation Junction and Storage Temperature Range	$T_J, T_{STG}$	$^\circ\text{C}$		-55 ~ +150						

#### Electrical Characteristics ( $T=25^\circ\text{C}$ Unless otherwise specified)

Item	Symbol	Unit	Test Condition	RS3						
				A	B	D	G	J	K	M
Peak Forward Voltage	$V_F$	V	$I_F=3.0\text{A}$	1.3						
Maximum reverse recovery time	$t_{rr}$	ns	$I_F=0.5\text{A}, I_R=1.0\text{A}, I_{tr}=0.25\text{A}$	150			250		500	
Peak Reverse Current	$I_{RRM1}$	$\mu\text{A}$	$V_{RM}=V_{RRM}$	$T_a=25^\circ\text{C}$						
	$I_{RRM2}$			$T_a=125^\circ\text{C}$						
Thermal Resistance(Typical)	$R_{\theta J-A}$	$^\circ\text{C}/\text{W}$	Between junction and ambient		65					
	$R_{\theta J-L}$		Between junction and terminal		13					
Juction Capacitance (Typical)	$C_j$	pF	Measured at 1MHZ and Applied Reverse Voltage of 4.0 V.D.C		20					

#### Notes:

Thermal resistance from junction to ambient and from junction to lead mounted on FR4 PCB double sided copper mini pad

# Typical Characteristics

FIG.1: FORWARD CURRENT DERATING CURVE

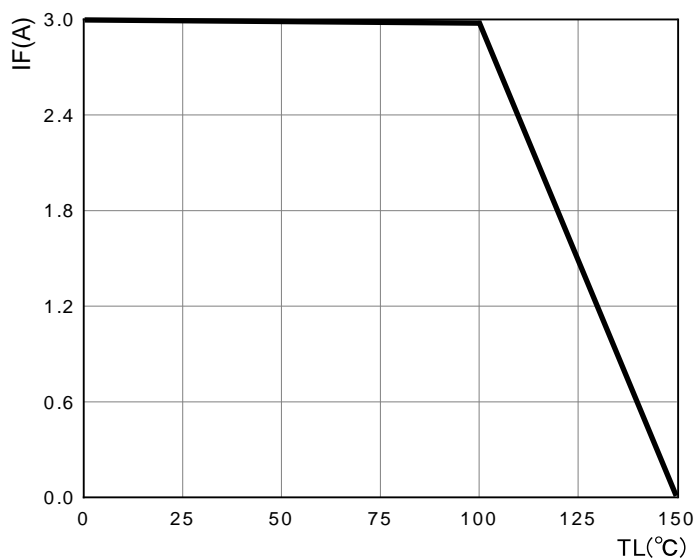

FIG.2: MAXIMUM NON-REPETITIVE FORWARD SURGE CURRENT



FIG.3 : TYPICAL FORWARD CHARACTERISTICS

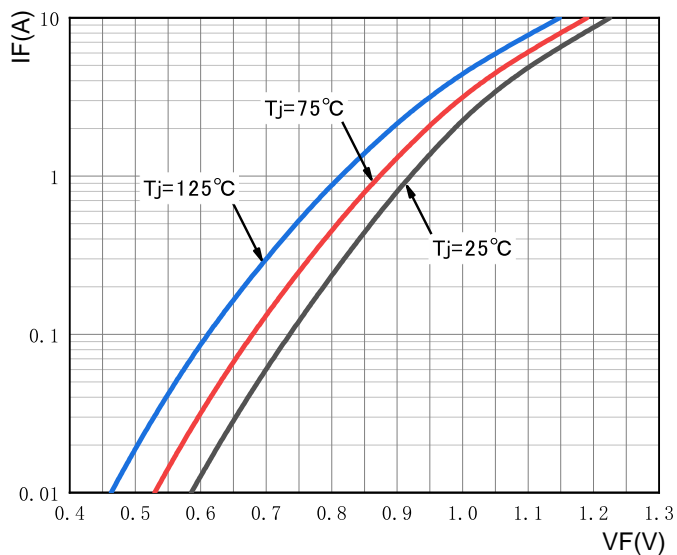
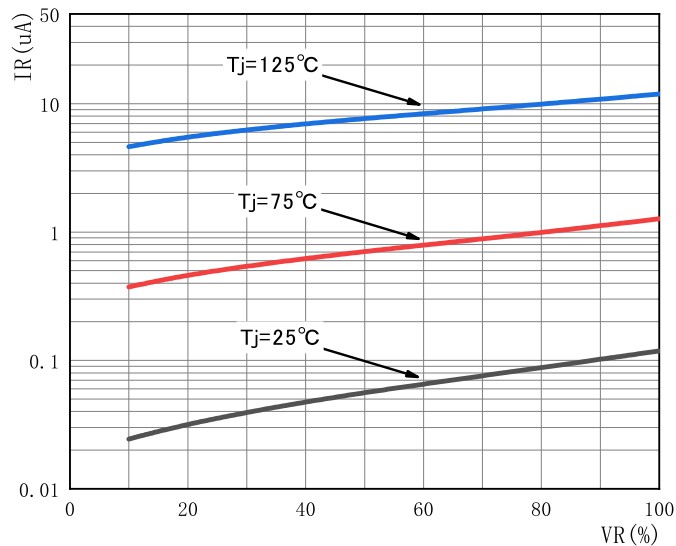
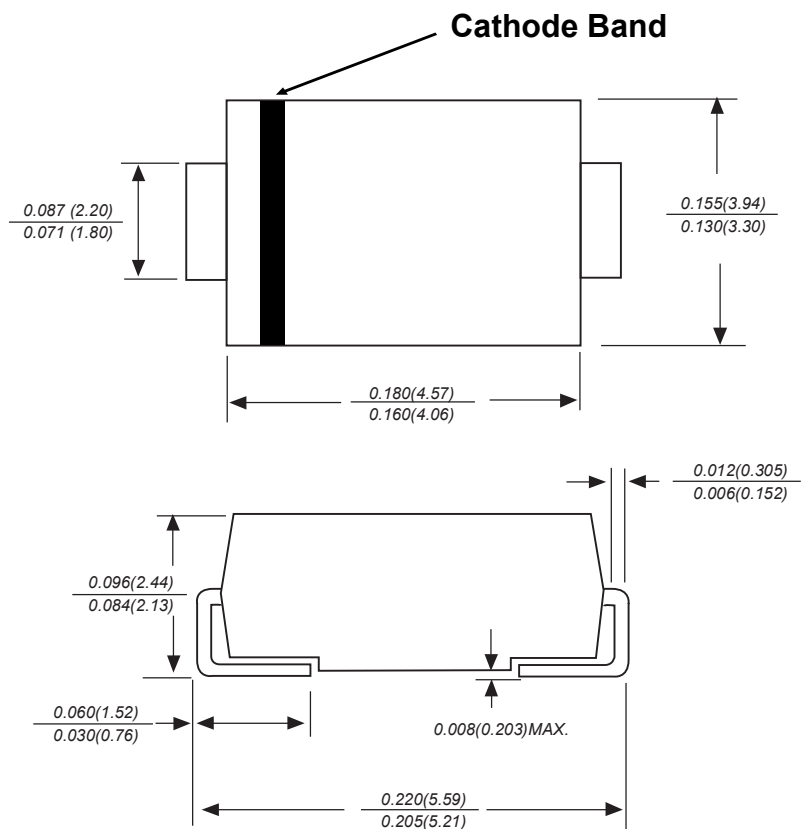

FIG.4 TYPICAL REVERSE CHARACTERISTICS



## SMBG Package Outline Dimensions



Dimensions in inches and (millimeters)

## SMBG Suggested Pad Layout

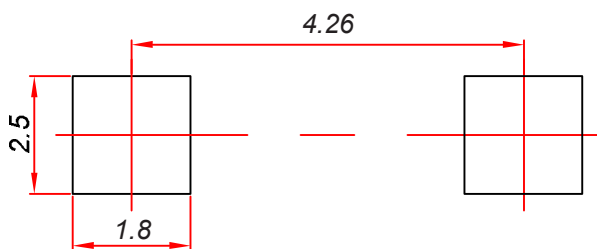

### Note:

1. Controlling dimension: in millimeters.
2. General tolerance:  $\pm 0.05$  mm.
3. The pad layout is for reference purposes only.

### NOTICE

JSCJ reserves the right to make modifications, enhancements, improvements, corrections or other changes without further notice to any product herein. JSCJ does not assume any liability arising out of the application or use of any product described herein.

# Reel Taping Specifications For Surface Mount Devices–SMBG

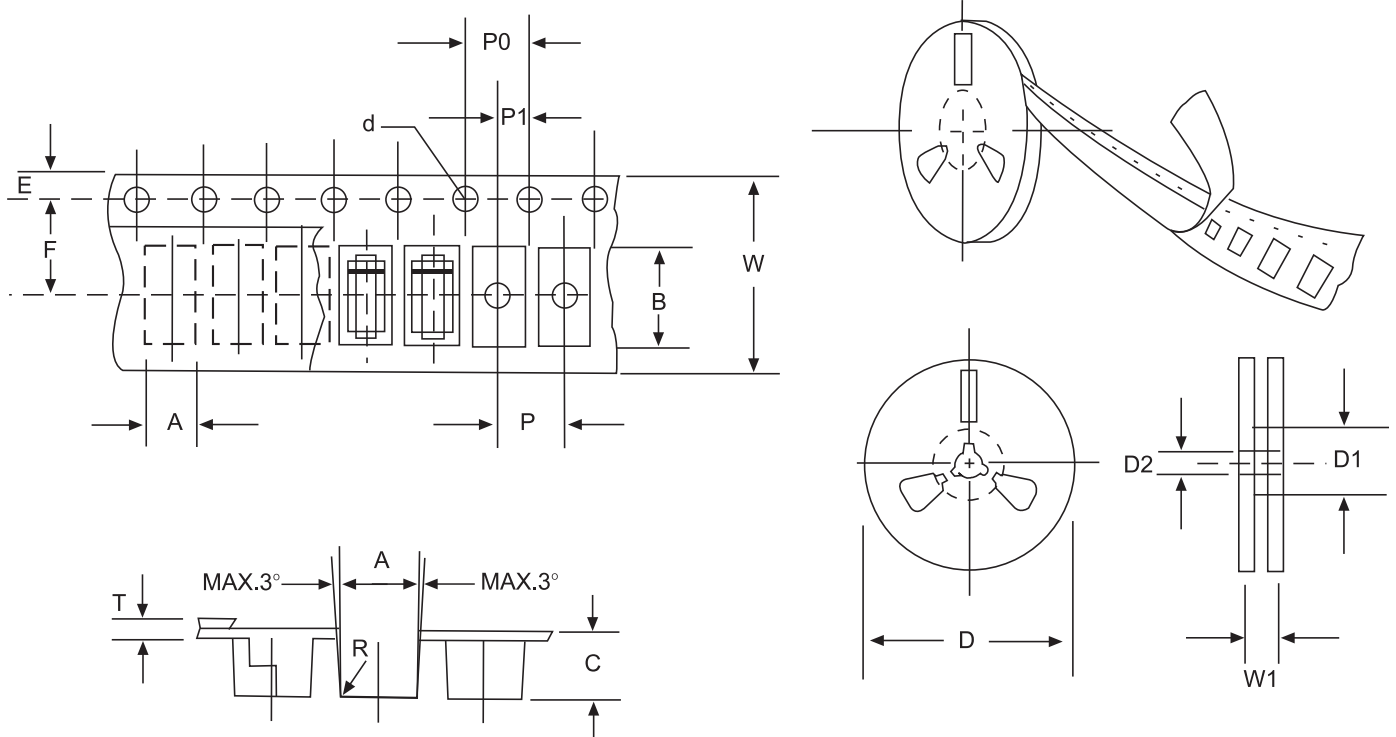

**FIG: CONFIGURATION OF SURFACE MOUNTED DEVICES TAPING**

ITEM	SYMBOL	SMBG mm(inch)
Carrier width	A	4.09±0.1(0.161±0.004)
Carrier length	B	5.82±0.1(0.229±0.004)
Carrier depth	C	2.50±0.1(0.100±0.004)
Sprocket hole	d	1.55±0.05 (0.061±0.002)
Reel outside diameter	D	330±2.0(13±0.079)
Reel inner diameter	D1	75 ±1.0 ( 2.95 ±0.039)
Feed hole diameter	D2	13±0.5(0.512±0.020)
Stroket hole position	E	1.75±0.1(0.069±0.004)
Punch hole position	F	5.65±0.05(0.222±0.002)
Punch hole pitch	P	8.0±0.1(0.315±0.004)
Sprocket hole pitch	P0	4.0±0.1(0.157±0.004)
Embossment center	P1	2.0±0.1(0.079±0.004)
Total tape thickness	T	0.32±0.1 (0.013±0.004)
Tape width	W	12.0±0.2(0.472±0.008)
Reel width	W1	16.8±2.0(0.661±0.079)

NOTE: Devices are packed in accordance with EIA standard RS-481-A and specification given above.