



TO-252-2L Plastic-Encapsulate Diode

MURD8H60 HYPERFAST RECTIFIER,FRED

MAIN CHARACTERISTICS

I_O	8A
V_{RRM}	600V
T_{rr}	25ns
T_j	175°C
$V_{F(typ)}$	1.06V(@$T_j=150^\circ\text{C}$)

FEATURES

- Ultrafast Recovery Times and Low Recovery Loss
- Low Forward Voltage
- Low Reverse Leakage Current

APPLICATIONS

Specifically designed to improve efficiency of PFC and output rectification stages of EV / HEV battery charging stations, booster stage of solar inverters and UPS applications, these devices are perfectly matched to operate with MOSFETs or high speed IGBTs.

MARKING

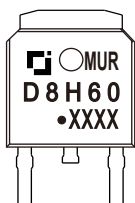

MURD8H60 = Device code
 Solid dot = Green molding compound device
 if none, the normal device
 XXXX = Code

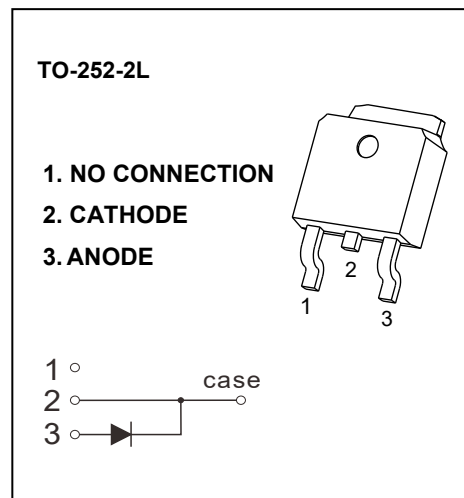

MAXIMUM RATINGS ($T_c=25^\circ\text{C}$ unless otherwise noted)

Symbol	Parameter	MURD8H60	Unit
V_{RRM}	Peak Repetitive Reverse Voltage	600	V
V_R	DC Blocking Voltage		
$I_{F(AV)}$	Average Forward Current($T_c=150^\circ\text{C}$)	8	A
$I_{F(RMS)}$	RMS Forward Current($T_c=150^\circ\text{C}$)	11	A
I_{FSM}	Non-Repetitive Surge Forward Current (8.3ms)	112	A
P_D	Power dissipation	77	W
$R_{\theta JC}$	Thermal Resistance From Junction to Case	1.95	$^\circ\text{C}/\text{W}$
T_j	Operating Junction Temperature Range	-55 ~ +175	$^\circ\text{C}$
T_{stg}	Storage Temperature Range	-55 ~ +175	$^\circ\text{C}$

Typical Characteristics

ELECTRICAL CHARACTERISTICS ($T_c=25^\circ\text{C}$ unless otherwise specified)

Symbol	Parameter	Test Conditions	Min.	Typ.	Max.	Unit
$V_{(BR)}$	Reverse Voltage	$I_R=100\mu\text{A}$	600			V
I_R	Reverse Current	$V_R=600\text{V}$	$T_j=25^\circ\text{C}$		10	μA
			$T_j=150^\circ\text{C}$		500	μA
V_F	Forward Voltage	$I_F=8\text{A}$	$T_j=25^\circ\text{C}$	1.25	1.6	V
			$T_j=150^\circ\text{C}$	1.06		V
C_{tot}	Total Capacitance	$V_R=200\text{V}, f=1\text{MHz}$		8		pF
trr	Reverse Recovery time	$I_F=0.5\text{A}, I_R=1\text{A}, I_{rr}=0.25\text{A}$		34		ns
		$I_F=1\text{A}, V_R=30\text{V}, di_F/dt=200\text{A}/\mu\text{s}$		25		ns

ELECTRICAL CHARACTERISTICS ($T_c=25^\circ\text{C}$ unless otherwise specified)

Symbol	Parameter	Test Conditions	Min.	Typ.	Max.	Unit
trr	Reverse Recovery Time	$I_F=8\text{A}, V_R=400\text{V}, di_F/dt=200\text{A}/\mu\text{s}$		68		ns
I_{RRM}	Max. Reverse Recovery Current			4.9		A
Qrr	Reverse Recovery Charge			185		nC
trr	Reverse Recovery Time	$I_F=8\text{A}, V_R=400\text{V}, di_F/dt=200\text{A}/\mu\text{s}, T_j=125^\circ\text{C}$		97		ns
I_{RRM}	Max. Reverse Recovery Current			8		A
Qrr	Reverse Recovery Charge			433		nC
trr	Reverse Recovery Time	$I_F=8\text{A}, V_R=400\text{V}, di_F/dt=500\text{A}/\mu\text{s}, T_j=125^\circ\text{C}$		74		ns
I_{RRM}	Max. Reverse Recovery Current			13		A
Qrr	Reverse Recovery Charge			562		nC

Typical Characteristics

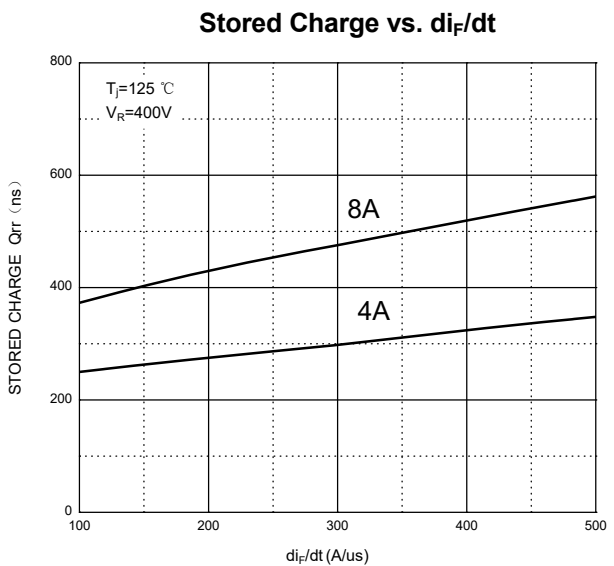
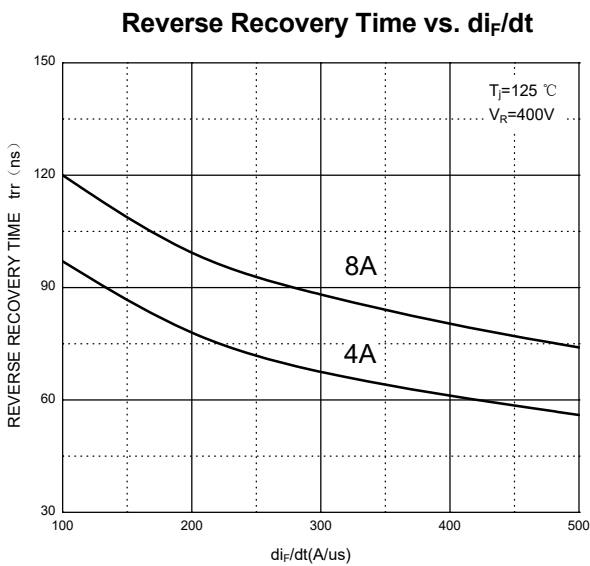
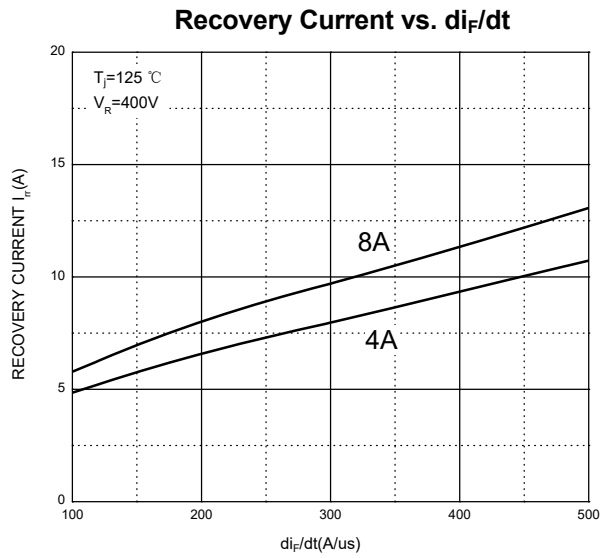
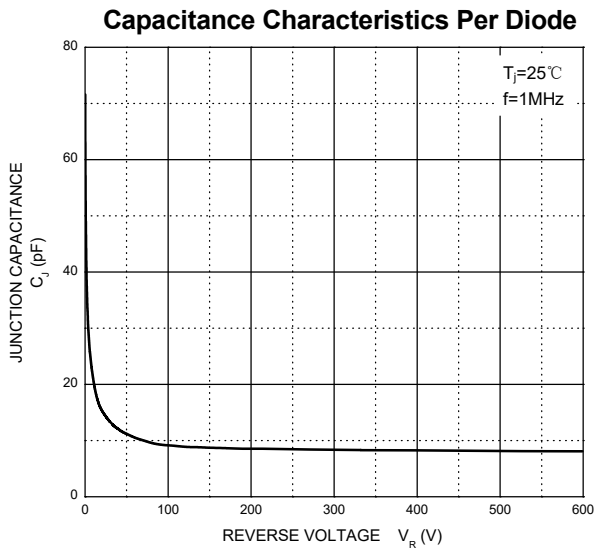
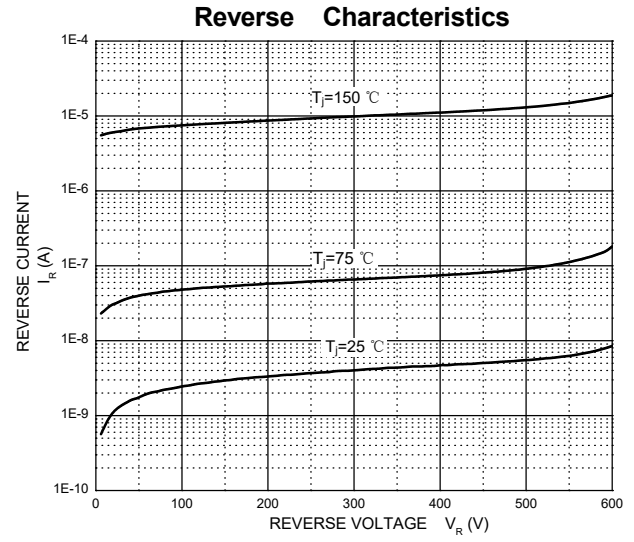
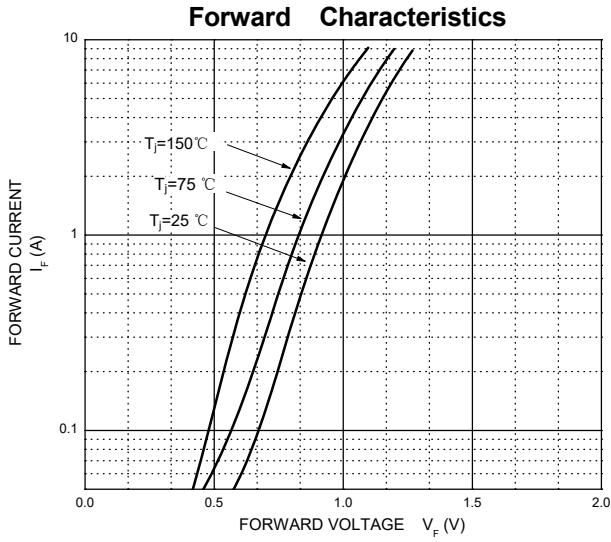

Typical Characteristics

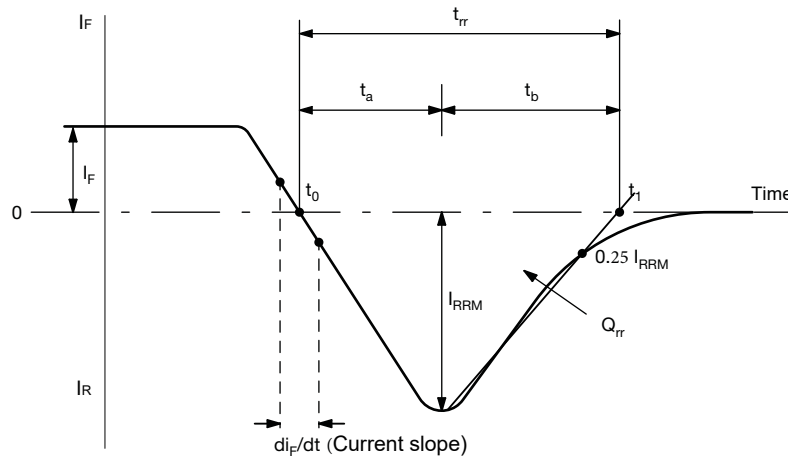

Reverse Recovery Waveform and Definitions

MURD8H60 Transient Thermal Impedance, Junction-Case

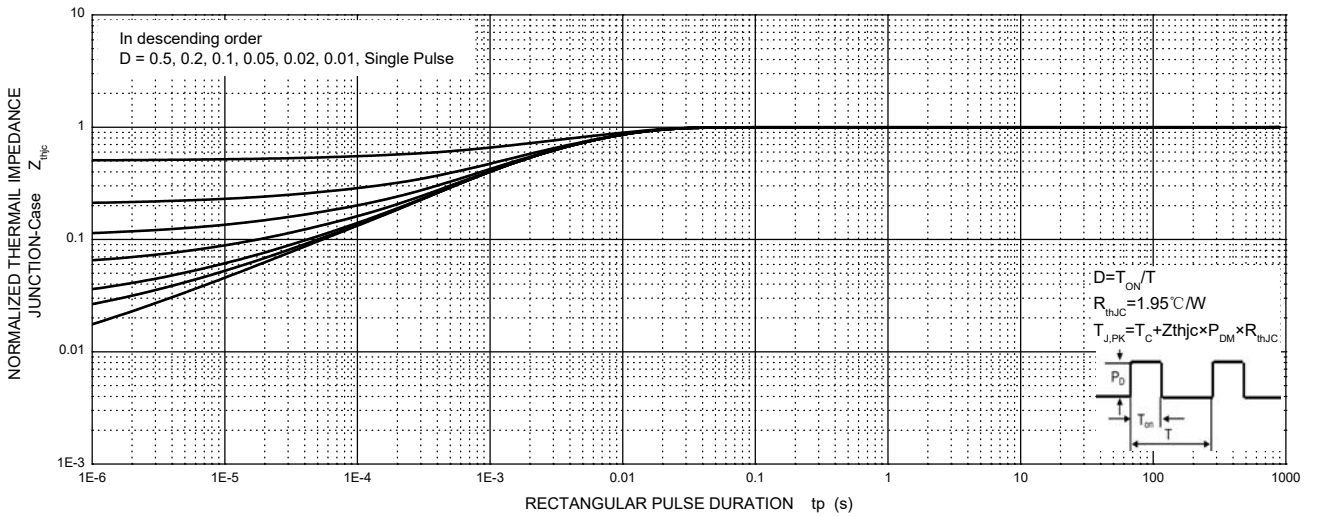

TO-252-2L Package Outline Dimensions

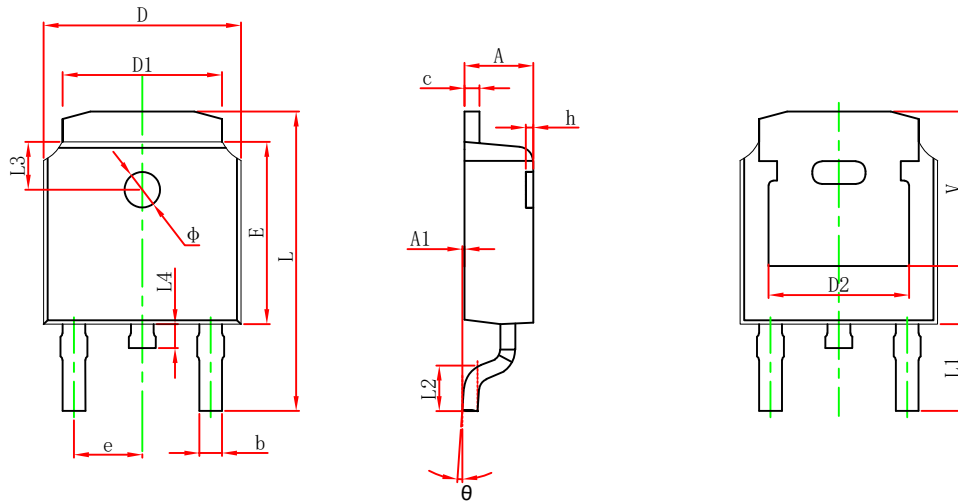

Symbol	Dimensions In Millimeters		Dimensions In Inches	
	Min.	Max.	Min.	Max.
A	2.200	2.400	0.087	0.094
A1	0.000	0.127	0.000	0.005
b	0.635	0.770	0.025	0.030
c	0.460	0.580	0.018	0.023
D	6.500	6.700	0.256	0.264
D1	5.100	5.460	0.201	0.215
D2	4.830 REF.		0.190 REF.	
E	6.000	6.200	0.236	0.244
e	2.186	2.386	0.086	0.094
L	9.712	10.312	0.382	0.406
L1	2.900 REF.		0.114 REF.	
L2	1.400	1.700	0.055	0.067
L3	1.600 REF.		0.063 REF.	
L4	0.600	1.000	0.024	0.039
phi	1.100	1.300	0.043	0.051
theta	0°	8°	0°	8°
h	0.000	0.300	0.000	0.012
V	5.250 REF.		0.207 REF.	

TO-252-2L Suggested Pad Layout

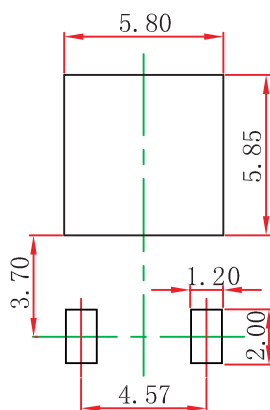

- Note:
1. Controlling dimension: in millimeters.
 2. General tolerance: ± 0.05 mm.
 3. The pad layout is for reference purposes only.

NOTICE

JSCJ reserves the right to make modifications, enhancements, improvements, corrections or other changes without further notice to any product herein. JSCJ does not assume any liability arising out of the application or use of any product described herein.

TO-252-2L Package Outline Dimensions

TO-252 Embossed Carrier Tape

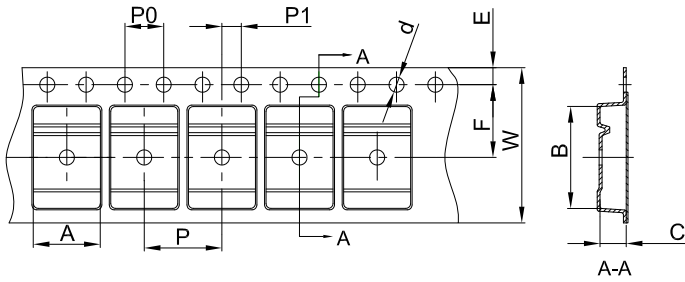

Packaging Description:

TO-252 parts are shipped in tape. The carrier tape is made from a dissipative (carbon filled) polycarbonate resin. The cover tape is a multilayer film (Heat Activated Adhesive in nature) primarily composed of polyester film, adhesive layer, sealant, and anti-static sprayed agent. These reeled parts in standard option are shipped with 25,00 units per 13" or 33.0 cm diameter reel. The reels are clear in color and is made of polystyrene plastic (anti-static coated).

Dimensions are in millimeter

Pkg type	A	B	C	d	E	F	P0	P	P1	W
TO-252	6.90	10.50	2.70	Ø1.55	1.75	7.50	4.00	8.00	2.00	16.00

TO-252 Tape Leader and Trailer

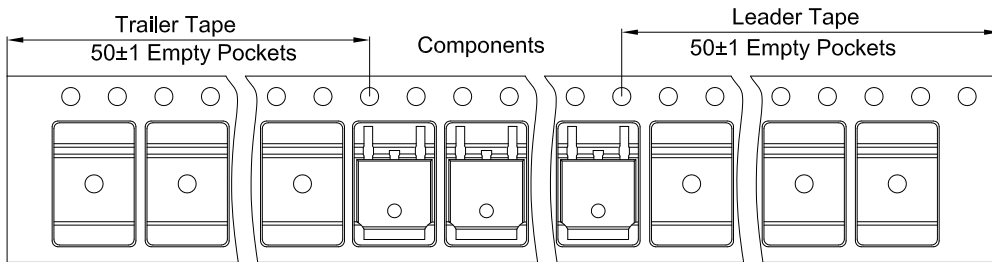

TO-252 Reel

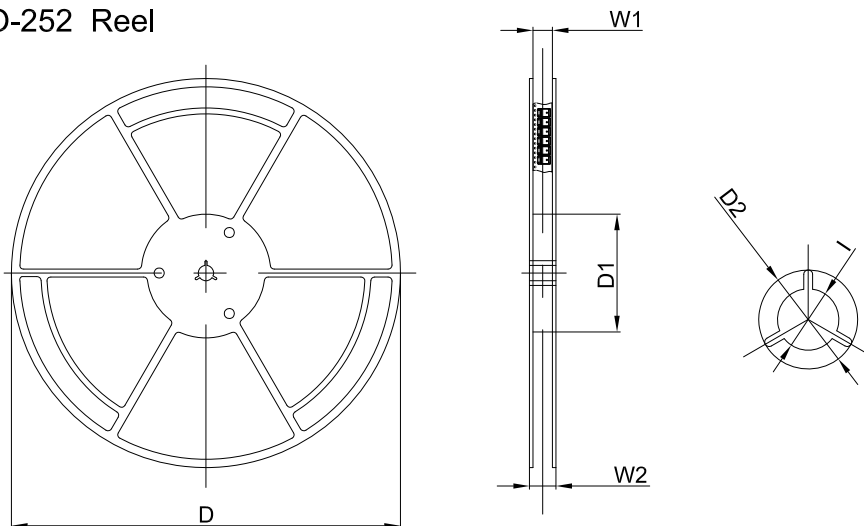

Dimensions are in millimeter

Reel Option	D	D1	D2	W1	W2	I
13" Dia	330.00	100.00	Ø21.00	16.40	21.00	Ø13.00

REEL	Reel Size	Box	Box Size(mm)	Carton	Carton Size(mm)	G.W.(kg)
2,500 pcs	13inch	2,500 pcs	340×336×29	25,000 pcs	353×346×365	