

## Specifications

Current rating:12.5A AC,DC

Voltage rating:600V AC,DC

Temperature range:-40°C~+105°C

Contact resistance:10mΩ Max.

Insulation resistance:1000MΩ Min.

Withstanding voltage:1500V AC/minute

\*Compliant with RoHS and REACH\*

\*Meet the HF/Halogen Free,GWT/Glow wire Test (IEC60335-1) request,need to customize\*

\*Contact CJT for details\*

## Standards



E326732



E326732

**Assembly layout**

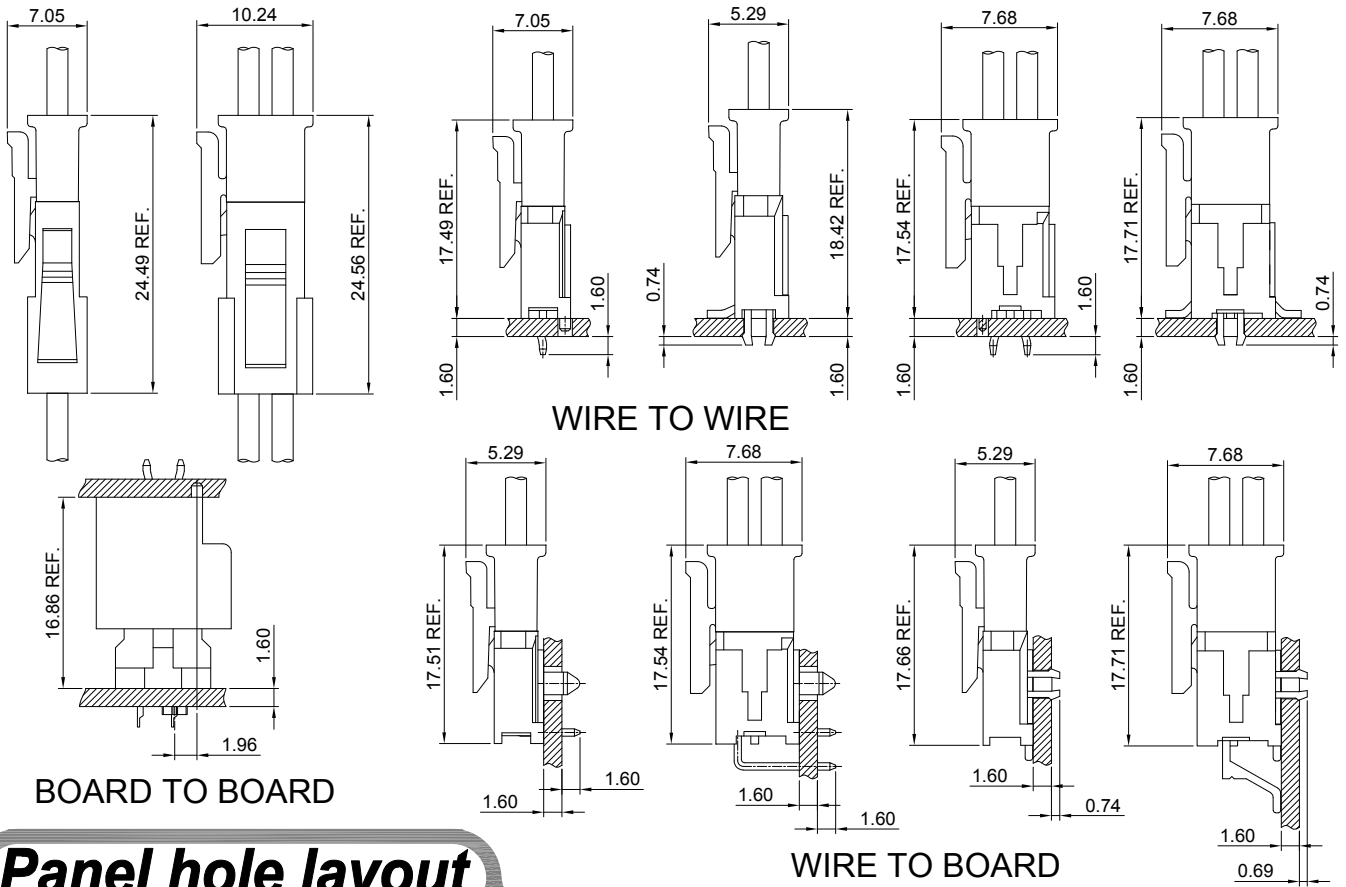

**Panel hole layout**

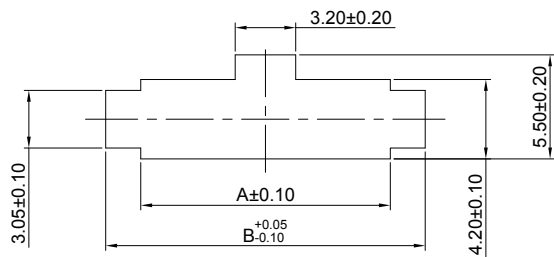

**SINGLE ROW**

**RECOMMENDED PANEL CUT-OUT**  
(DESIGNED FOR 1.57mm TO 2.30mm THICK STAMPED PANEL OR PRINTED CIRCUIT BOARD)

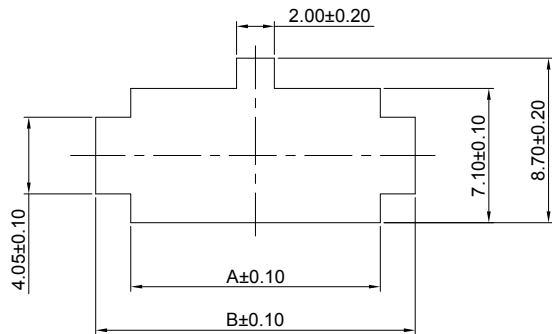

**DUAL ROW**

**RECOMMENDED PANEL CUT-OUT**  
(DESIGNED FOR 1.40mm TO 2.54mm THICK STAMPED PANEL OR PRINTED CIRCUIT BOARD)

PART NO.		Dimensions	
SINGLE ROW	DUAL ROW	A	B
-----	C3030HM-2X1P(-A)	4.20	7.90
C3030HM-2P	C3030HM-2X2P(-A)	7.20	10.90
C3030HM-3P	C3030HM-2X3P(-A)	10.20	13.90
C3030HM-4P	C3030HM-2X4P(-A)	13.20	16.90
C3030HM-5P	C3030HM-2X5P(-A)	16.20	19.90
C3030HM-6P	C3030HM-2X6P(-A)	19.20	22.90
C3030HM-7P	C3030HM-2X7P(-A)	22.20	25.90
C3030HM-8P	C3030HM-2X8P(-A)	25.20	28.90
C3030HM-9P	C3030HM-2X9P(-A)	28.20	31.90
C3030HM-10P	C3030HM-2X10P(-A)	31.20	34.90
C3030HM-11P	C3030HM-2X11P(-A)	34.20	37.90
C3030HM-12P	C3030HM-2X12P(-A)	37.20	40.90

Unit:mm

### C3030HF

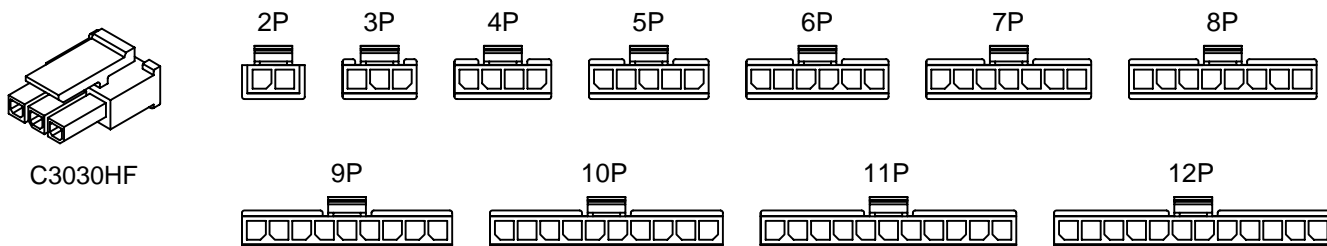

### C3030HM C3030HMA

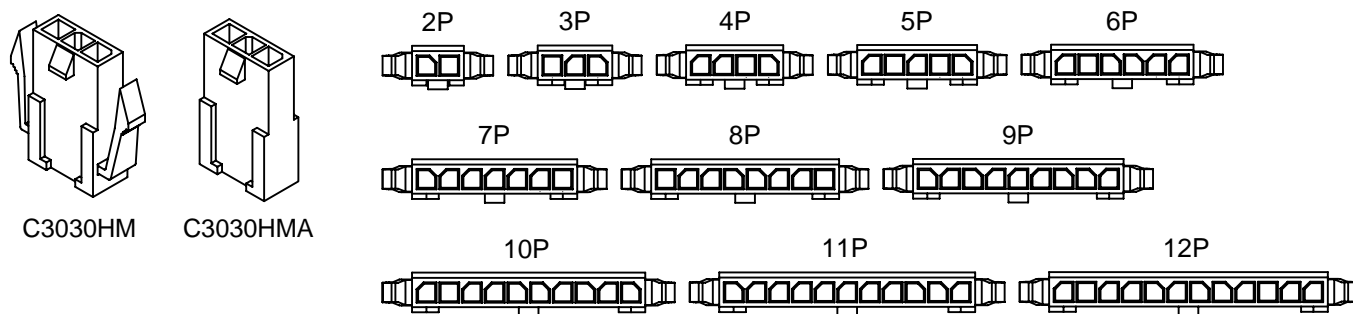

### C3030WV C3030WV-S C3030WV-S-F

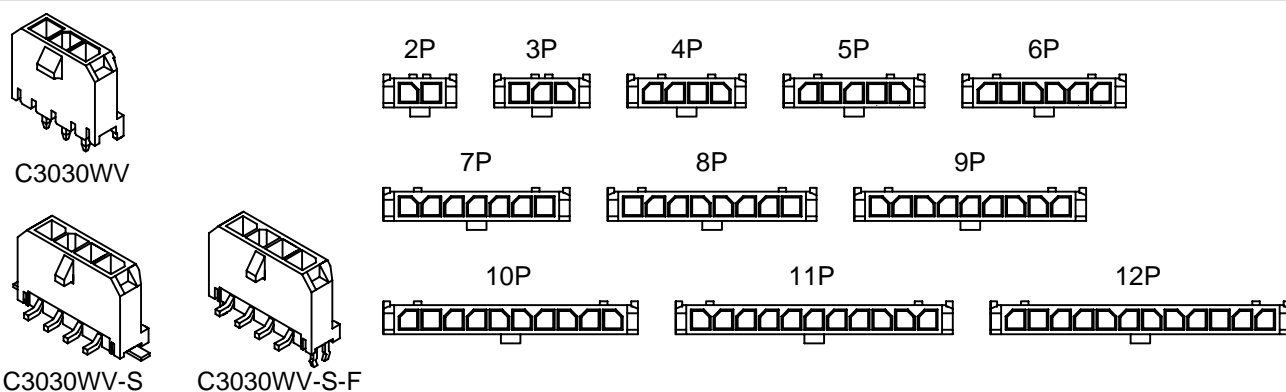

### C3030WR C3030WR-S C3030WR-S-F

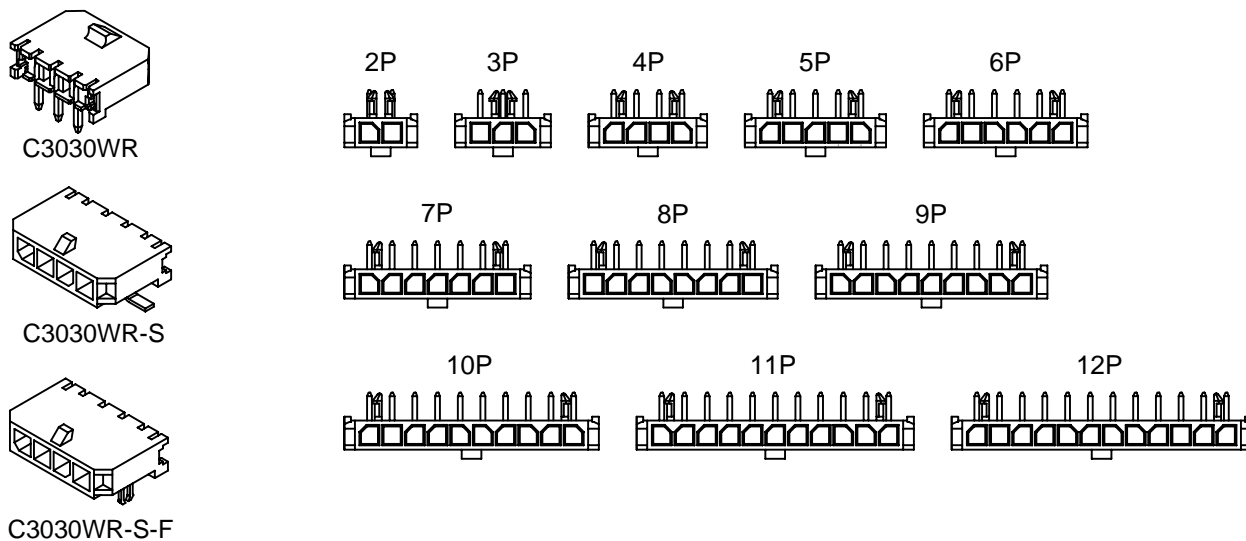

### C3030HF-2

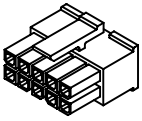

C3030HF-2

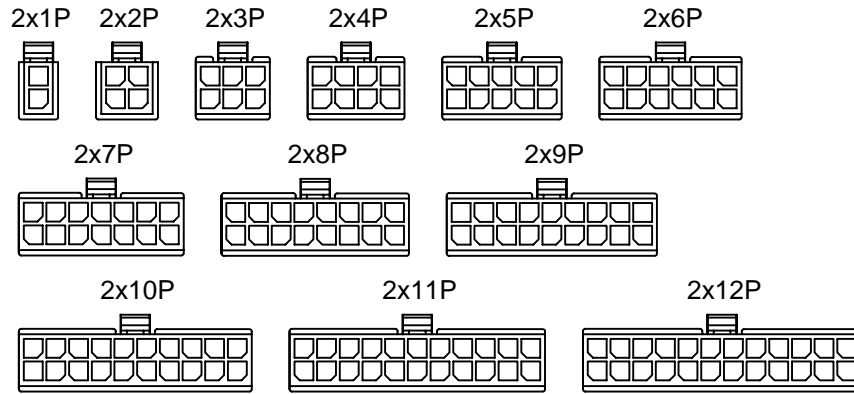

### C3030HM-2 C3030HMA-2 C3030HMC-2

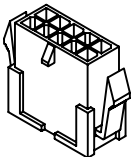

C3030HM-2

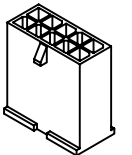

C3030HMC-2

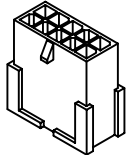

C3030HMA-2

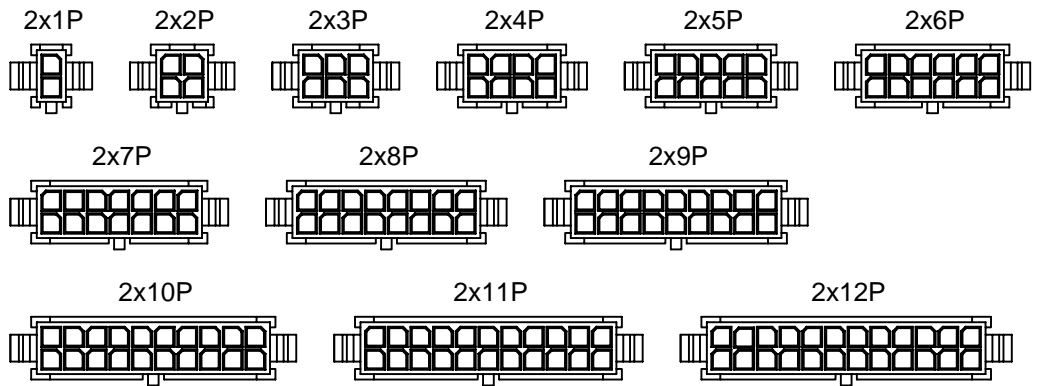

### C3030WV-2 C3030WV-S-2 C3030WV-S-F-2

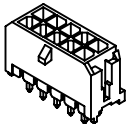

C3030WV-2

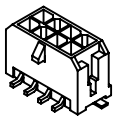

C3030WV-S-2

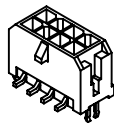

C3030WV-S-F-2

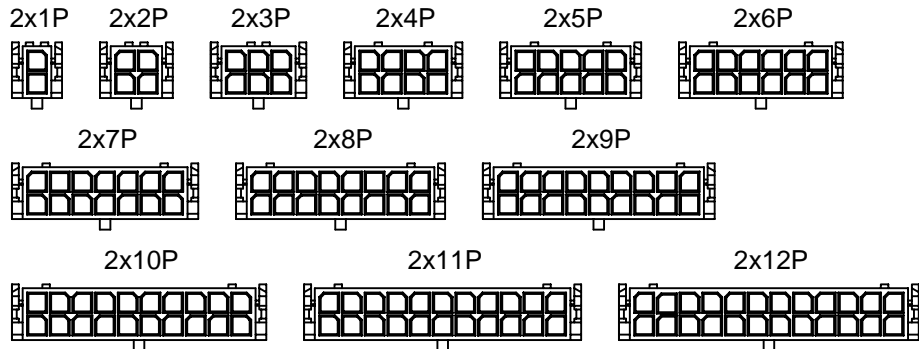

### C3030WR-2 C3030WRA-2 C3030WRA-F-2 C3030WR-S-2 C3030WR-S-F-2

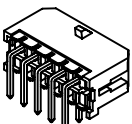

C3030WR-2

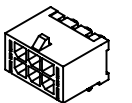

C3030WRA-2

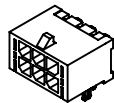

C3030WRA-F-2

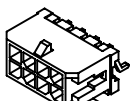

C3030WR-S-2

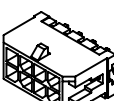

C3030WR-S-F-2

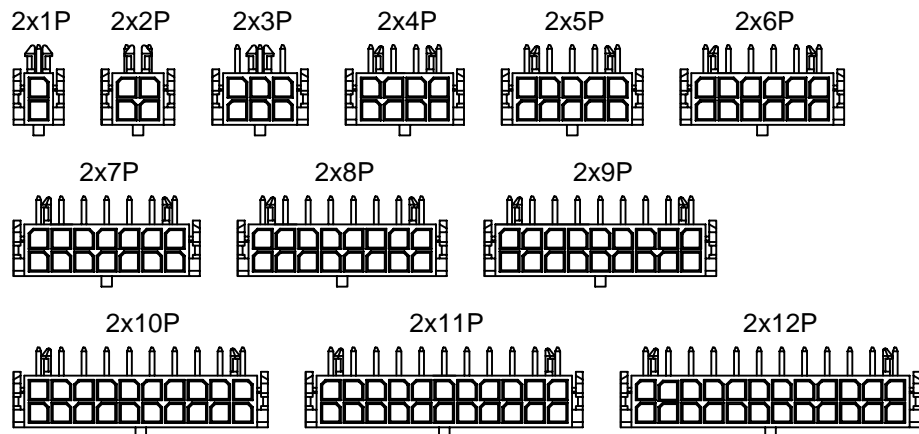

### C3030HFB-2

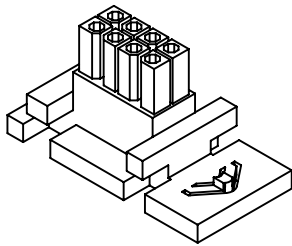

C3030HFB-2

2x1P			2x12P
2x2P			2x11P
2x3P			2x10P
2x4P			2x9P
2x5P			2x8P
2x6P			2x7P

### C3030HMB-2

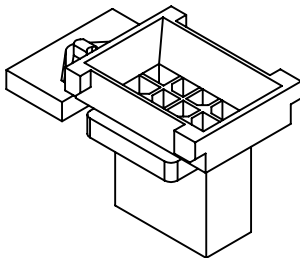

C3030HMB-2

2x1P			2x12P
2x2P			2x11P
2x3P			2x10P
2x4P			2x9P
2x5P			2x8P
2x6P			2x7P

### C3030F-T-A

3.00mm pitch Crimp Terminal

**Reference Informations:**

\*Used in CJT C3030HF-2P~12P, C3030HF-2x1P~2x6P series Housing

**Ordering Information:**

C3030F-GP-A(-L) - \*\*\*  
1 2

1.Part No.

2.Finish:

(blank): Gold-flash

100µin (2.54µm) MIN.Select Tin

G15:15µin (0.38µm) MIN.Select Gold

100µin (2.54µm) MIN.Select Tin

G30:30µin (0.76µm) MIN.Select Gold

100µin (2.54µm) MIN.Select Tin

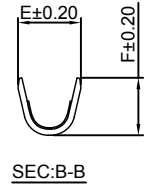
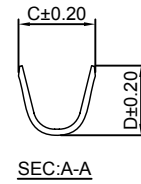
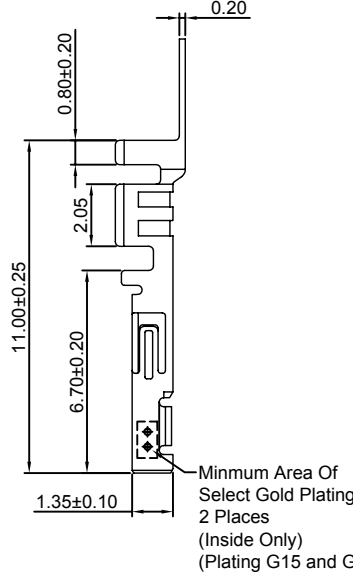
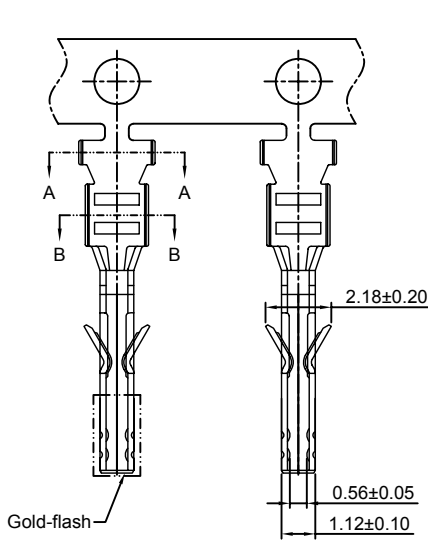

**Ordering information & Specifications:**

Unit:mm

Part NO.	Wire Range	Insulation O.D.	Material	Finish	C	D	E	F	Qty/reel
C3030F-TP-A	AWG#20-#24	1.85mm(max)	Phosphor Bronze	Tin over Nickel	2.54	2.30	2.08	1.90	10,000 PCS
C3030F-GP-A	AWG#20-#24	1.85mm(max)	Phosphor Bronze	Gold-flash	2.54	2.30	2.08	1.90	10,000 PCS
C3030F-TP-A-L	AWG#26-#30	1.27mm(max)	Phosphor Bronze	Tin over Nickel	2.10	1.90	1.65	1.46	10,000 PCS
C3030F-GP-A-L	AWG#26-#30	1.27mm(max)	Phosphor Bronze	Gold-flash	2.10	1.90	1.65	1.46	10,000 PCS

Optional Gold plating available but MOQ requested

### C3030F-T-C

3.00mm pitch Crimp Terminal

**Reference Informations:**

\*Used in CJT C3030HF-2x7P~2x12P, C3030HFB-2xXP series Housing

**Ordering Information:**

C3030F-GP-C - \*\*\*  
1 2

1.Part No.

2.Finish:

(blank): Gold-flash

100µin (2.54µm) MIN.Select Tin

G15:15µin (0.38µm) MIN.Select Gold

100µin (2.54µm) MIN.Select Tin

G30:30µin (0.76µm) MIN.Select Gold

100µin (2.54µm) MIN.Select Tin

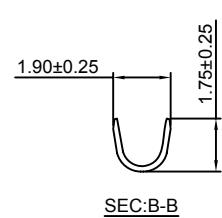
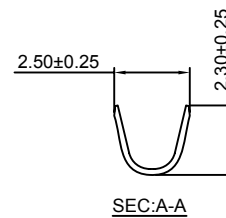
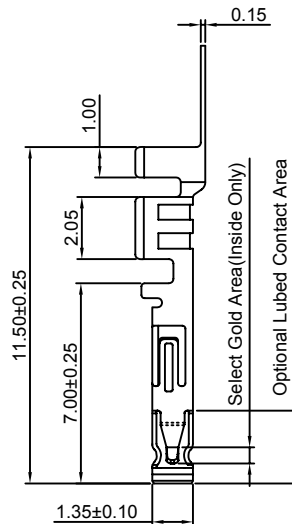
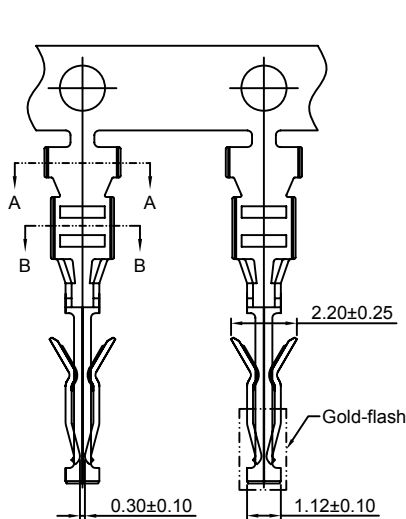

**Ordering information & Specifications:**

Unit:mm

Part NO.	Wire Range	Insulation O.D.	Material	Finish	Qty/reel
C3030F-TP-C	AWG#20-#24	1.85mm(max)	Phosphor Bronze	Tin over Nickel	10,000 PCS
C3030F-GP-C	AWG#20-#24	1.85mm(max)	Phosphor Bronze	Gold-flash	10,000 PCS

Optional Gold plating available but MOQ requested

### C3030M-T

3.00mm pitch Crimp Terminal

**Reference Informations:**

\*Used in CJT C3030HM, HMA-XP, C3030HM, HMA, HMC-2xXP, C3030HM-2xXP-A, C3030HMB-2xXP series Housing

**Ordering Information:**

C3030M-GP(-L) - \*\*\*  
 $\frac{1}{2}$

1. Part No.

2. Finish:

(blank): Gold-flash

100µin (2.54µm) MIN. Select Tin

G15: 15µin (0.38µm) MIN. Select Gold

100µin (2.54µm) MIN. Select Tin

G30: 30µin (0.76µm) MIN. Select Gold

100µin (2.54µm) MIN. Select Tin

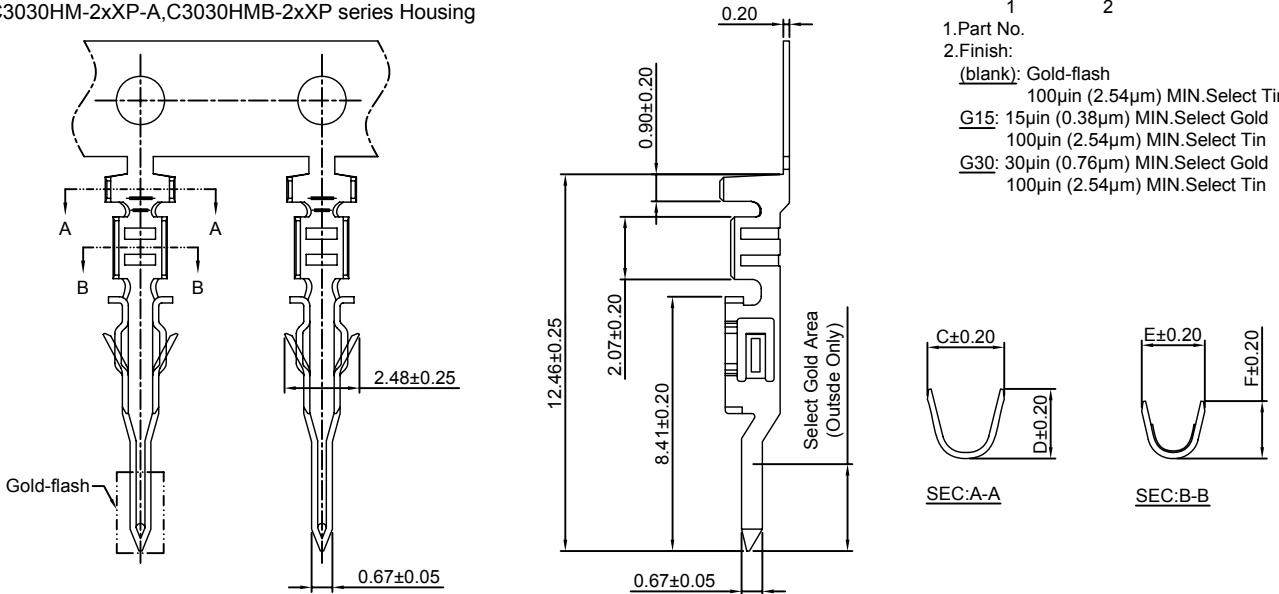

**Ordering information & Specifications:**

Unit:mm

Part NO.	Wire Range	Insulation O.D.	Material	Finish	C	D	E	F	Qty/reel
C3030M-TP	AWG#20-#24	1.85mm(max)	Phosphor Bronze	Tin over Nickel	2.54	2.30	2.08	1.90	10,000 PCS
C3030M-GP	AWG#20-#24	1.85mm(max)	Phosphor Bronze	Gold-flash	2.54	2.30	2.08	1.90	10,000 PCS
C3030M-TP-L	AWG#26-#30	1.27mm(max)	Phosphor Bronze	Tin over Nickel	2.10	1.90	1.65	1.46	10,000 PCS
C3030M-GP-L	AWG#26-#30	1.27mm(max)	Phosphor Bronze	Gold-flash	2.10	1.90	1.65	1.46	10,000 PCS

Optional Gold plating available but MOQ requested

### C3030HF-XP

3.00mm Pitch Single Row Housing

**Reference Informations:**

- \*Material:Nylon 66,UL94V-0
- \*Suitable CJT C3030F-T-A(-L) series Terminal
- \*Mates with CJT C3030HM,HMA-XP series Housing or C3030WV,WR-XP,C3030WV-S,WR-S-XP,C3030WV-F,WR-F-XP,C3030WV-S-F,WR-S-F-XP series Single Row Wafer
- \*Color:Black

Ordering Information:  
C3030HF-XP(-A) - \*\*\*  
1 2

- 1.Part No.
- 2.Material:  
(blank):Nylon 66,UL94V-0  
GWT:Nylon 66,UL94V-0,GWT 750 °C

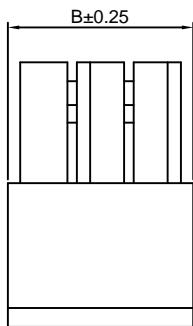
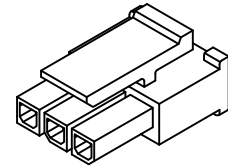
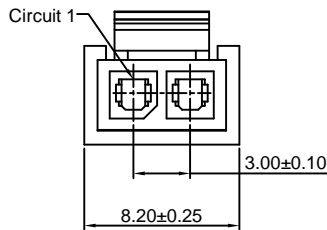
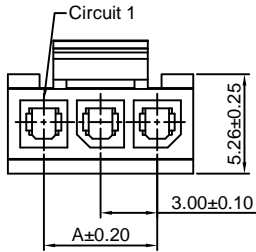

C3030HF-2P~12P

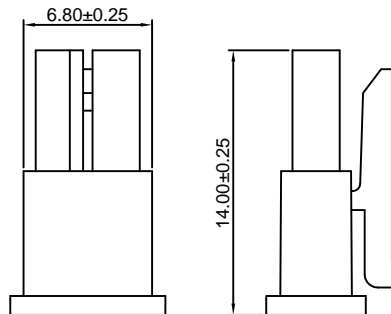

C3030HF-2P-A

Ordering Information & Dimensions:

PART NO.	Dimensions	
	A	B
2P	3.00	6.80
3P	6.00	9.80
4P	9.00	12.80
5P	12.00	15.80
6P	15.00	18.80
7P	18.00	21.80
8P	21.00	24.80
9P	24.00	27.80
10P	27.00	30.80
11P	30.00	33.80
12P	33.00	36.80

Unit: mm

### C3030HM-XP

3.00mm Pitch Single Row Housing

**Reference Informations:**

- \*Material:Nylon 66,UL94V-0
- \*Suitable CJT C3030M-T(-L) series Terminal
- \*Mates with CJT C3030HF-XP,C3030HF-2P-A series Housing
- \*Color:Black

Ordering Information:  
C3030HM-XP - \*\*\*  
1 2

- 1.Part No.
- 2.Material:  
(blank):Nylon 66,UL94V-0  
GWT:Nylon 66,UL94V-0,GWT 750 °C

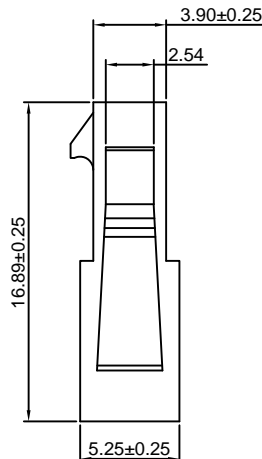
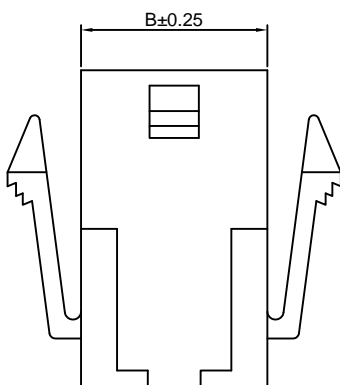
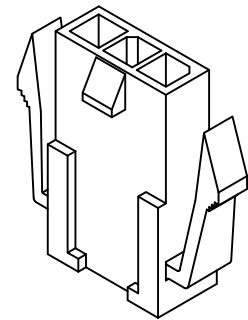
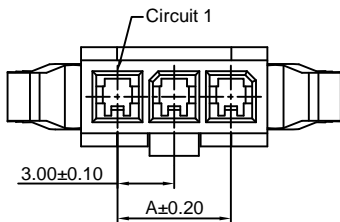

Ordering Information & Dimensions:

PART NO.	Dimensions	
	A	B
2P	3.00	6.85
3P	6.00	9.85
4P	9.00	12.85
5P	12.00	15.85
6P	15.00	18.85
7P	18.00	21.85
8P	21.00	24.85
9P	24.00	27.85
10P	27.00	30.85
11P	30.00	33.85
12P	33.00	36.85

Unit: mm



## C3030HMA-XP

3.00mm pitch Single Row Housing

**Reference Informations:**

- \*Material:Nylon 66,UL94V-0
- \*Suitable CJT C3030M-T(-L) series Terminal
- \*Mates with CJT C3030HF-XP,C3030HF-2P-A series Housing
- \*Color:Black

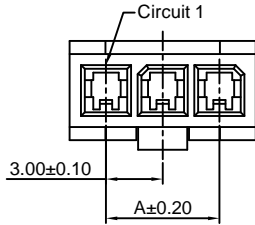

Ordering Information:  
C3030HMA-XP - \*\*\*  
1 2

- 1.Part No.
- 2.Material:  
(blank):Nylon 66,UL94V-0  
GWT:Nylon 66,UL94V-0,GWT 750 °C

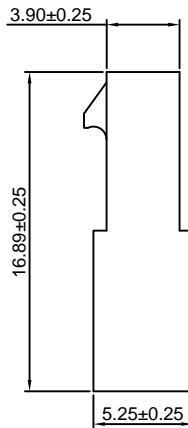
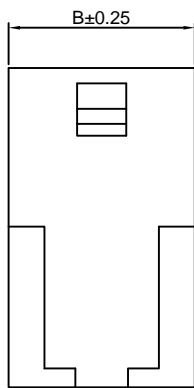
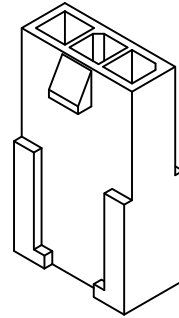

**Ordering Information & Dimensions:**

PART NO.	Dimensions	
	A	B
2P	3.00	6.85
3P	6.00	9.85
4P	9.00	12.85
5P	12.00	15.85
6P	15.00	18.85
7P	18.00	21.85
8P	21.00	24.85
9P	24.00	27.85
10P	27.00	30.85
11P	30.00	33.85
12P	33.00	36.85

Unit: mm

## C3030HF-2xXP

3.00mm pitch Dual Row Housing

**Reference Informations:**

- \*Material:Nylon 66,UL94V-0
- \*Suitable CJT C3030F-T-A(-L), C3030F-T-C series Terminal
- \*Mates with CJT C3030HM series Housing or C3030 series dual row Wafer
- \*Color:Black

Ordering Information:  
C3030HF-2xXP(-A) - \*\*\*  
1 2

- 1.Part No.
- 2.Material:  
(blank):Nylon 66,UL94V-0  
GWT:Nylon 66,UL94V-0,GWT 750 °C

Mates with CJT C3030 series Housing or Wafer :

Housing	C3030HM-2xXP,C3030HMA-2xXP,C3030HM-2xXP-A,C3030HMC-2xXP
Wafer	C3030WV-2xXP,C3030WV-S-2xXP,C3030WV-F-2xXP
	C3030WF-S-F-2xXP,C3030WR-2xXP,C3030WR-S-2xXP
	C3030WR-F-2xXP,C3030WR-S-F-2xXP,C3030WVA-2xXP
	C3030WVA-S-2xXP,C3030WRA-F-2xXP,C3030WRA-F1-2xXP
	C3030WRA-S-2xXP,C3030WRA-S-F-2xXP
	C3030WRA-S-F1-2xXP,C3030WVC-2xXP

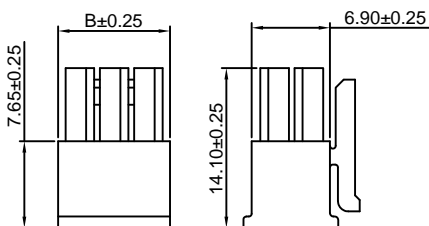
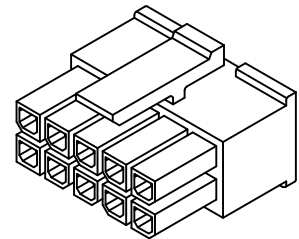
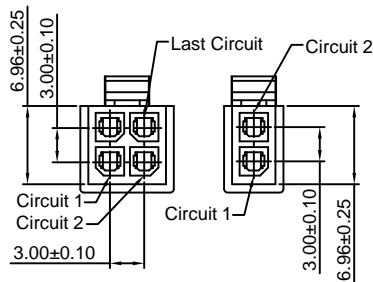
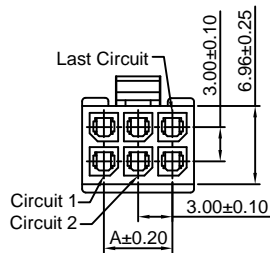

C3030HF-2x1P~2x12P

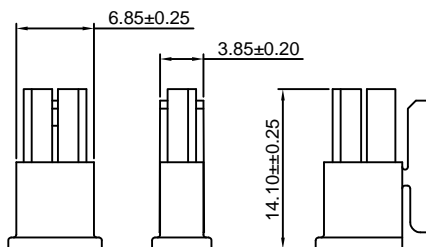

C3030HF-2x1P~2x2P-A

**Ordering Information & Dimensions:**

PART NO.	Dimensions	
	A	B
2x1P	----	3.85
2x2P	3.00	6.85
2x3P	6.00	9.85
2x4P	9.00	12.85
2x5P	12.00	15.85
2x6P	15.00	18.85
2x7P	18.00	21.85
2x8P	21.00	24.85
2x9P	24.00	27.85
2x10P	27.00	30.85
2x11P	30.00	33.85
2x12P	33.00	36.85

Unit: mm

### C3030HM-2xXP

3.00mm pitch Dual Row Housing

**Reference Informations:**

- \*Material:Nylon 66,UL94V-0
- \*Suitable CJT C3030M-T(-L) series Terminal
- \*Mates with CJT C3030HF-2xXP, C3030HF-2xXP-A series Housing
- \*Color:Black

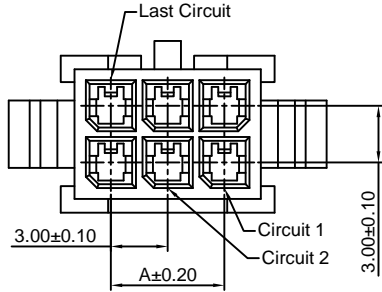

Ordering Information:  
C3030HM-2xXP - \*\*\*  
1 2

- 1.Part No.
- 2.Material:  
(blank):Nylon 66,UL94V-0  
GWT:Nylon 66,UL94V-0,GWT 750 °C

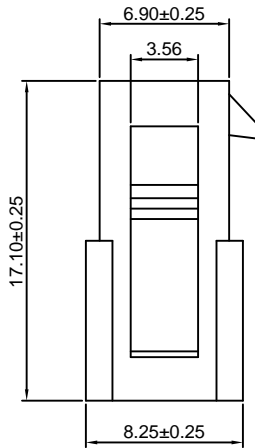
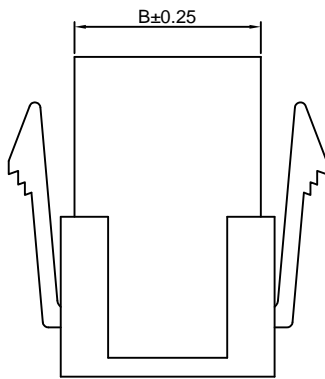
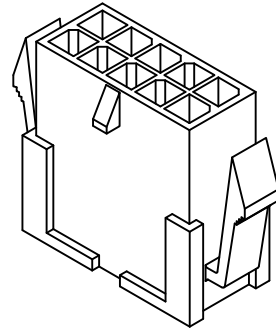

Ordering Information & Dimensions:

PART NO.	Dimensions	
	A	B
2x1P	----	3.85
2x2P	3.00	6.85
2x3P	6.00	9.85
2x4P	9.00	12.85
2x5P	12.00	15.85
2x6P	15.00	18.85
2x7P	18.00	21.85
2x8P	21.00	24.85
2x9P	24.00	27.85
2x10P	27.00	30.85
2x11P	30.00	33.85
2x12P	33.00	36.85

Unit: mm

### C3030HM-2xXP-A

3.00mm pitch Dual Row Housing

**Reference Informations:**

- \*Material:Nylon 66,UL94V-0
- \*Suitable CJT C3030M-T(-L) series Terminal
- \*Mates with CJT C3030HF-2xXP, C3030HF-2xXP-A series Housing
- \*Color:Black

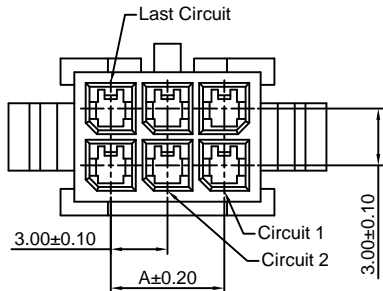

Ordering Information:  
C3030HM-2xXP-A - \*\*\*  
1 2

- 1.Part No.
- 2.Material:  
(blank):Nylon 66,UL94V-0  
GWT:Nylon 66,UL94V-0,GWT 750 °C

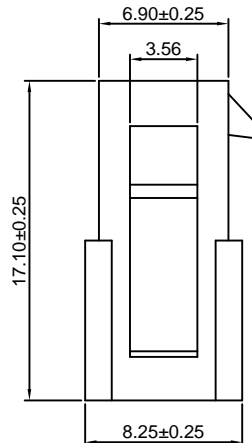
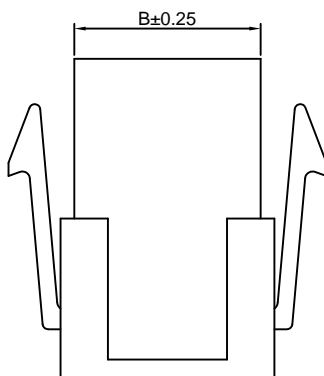
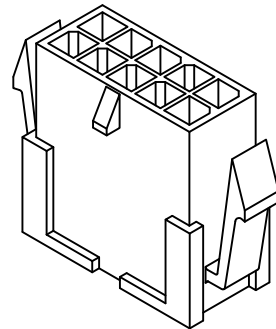

Ordering Information & Dimensions:

PART NO.	Dimensions	
	A	B
2x1P	----	3.85
2x2P	3.00	6.85
2x3P	6.00	9.85
2x4P	9.00	12.85
2x5P	12.00	15.85
2x6P	15.00	18.85
2x7P	18.00	21.85
2x8P	21.00	24.85
2x9P	24.00	27.85
2x10P	27.00	30.85
2x11P	30.00	33.85
2x12P	33.00	36.85

Unit: mm

### C3030HMA-2xXP

3.00mm pitch Dual Row Housing

**Reference Informations:**

- \*Material:Nylon 66,UL94V-0
- \*Suitable CJT C3030M-T(-L) series Terminal
- \*Mates with CJT C3030HF-2xXP, C3030HF-2xXP-A series Housing
- \*Color:Black

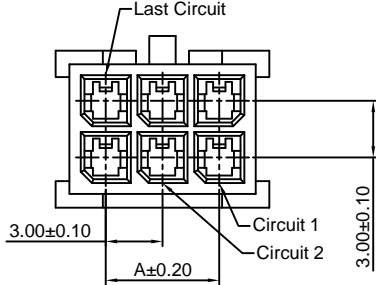

Ordering Information:  
C3030HMA-2xXP - \*\*\*  
1 2

- 1.Part No.
- 2.Material:  
(blank):Nylon 66,UL94V-0  
GWT:Nylon 66,UL94V-0,GWT 750 °C

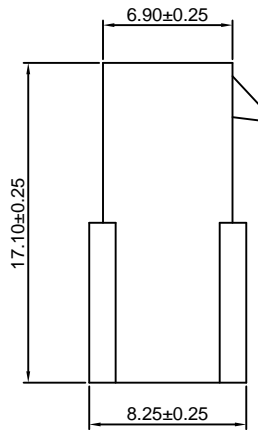
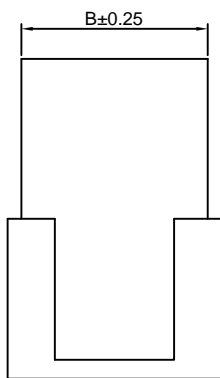
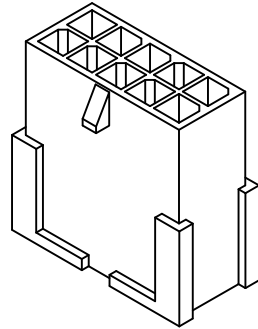

Ordering Information & Dimensions:

PART NO.	Dimensions	
	A	B
2x1P	----	3.85
2x2P	3.00	6.85
2x3P	6.00	9.85
2x4P	9.00	12.85
2x5P	12.00	15.85
2x6P	15.00	18.85
2x7P	18.00	21.85
2x8P	21.00	24.85
2x9P	24.00	27.85
2x10P	27.00	30.85
2x11P	30.00	33.85
2x12P	33.00	36.85

Unit: mm

### C3030HMC-2xXP

3.00mm pitch Dual Row Housing

**Reference Informations:**

- \*Material:Nylon 66,UL94V-0
- \*Suitable CJT C3030M-T(-L) series Terminal
- \*Mates with CJT C3030HF-2xXP, C3030HF-2xXP-A series Housing
- \*Color:Black

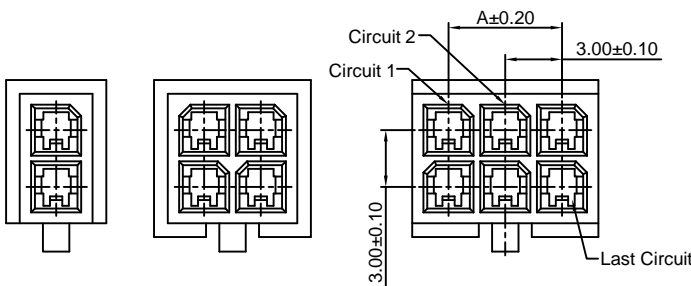

Ordering Information:  
C3030HMC-2xXP - \*\*\*  
1 2

- 1.Part No.
- 2.Material:  
(blank):Nylon 66,UL94V-0  
GWT:Nylon 66,UL94V-0,GWT 750 °C

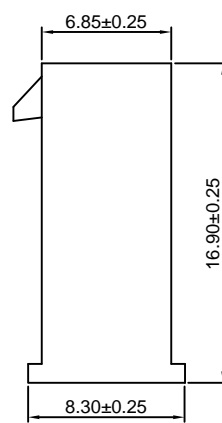
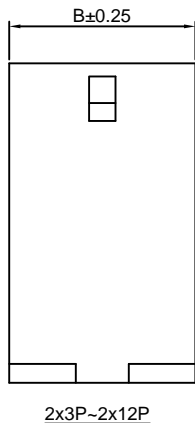
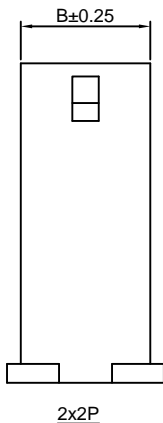
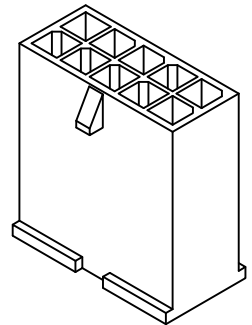

Ordering Information & Dimensions:

PART NO.	Dimensions	
	A	B
2x1P	----	3.85
2x2P	3.00	6.85
2x3P	6.00	9.85
2x4P	9.00	12.85
2x5P	12.00	15.85
2x6P	15.00	18.85
2x7P	18.00	21.85
2x8P	21.00	24.85
2x9P	24.00	27.85
2x10P	27.00	30.85
2x11P	30.00	33.85
2x12P	33.00	36.85

Unit: mm

### C3030HFB-2xXP

3.00mm pitch Dual Row Housing

**Reference Informations:**

- \*Material:Nylon 66,UL94V-0
- \*Suitable CJT C3030F-T-C series Terminal
- \*Mates with CJT C3030HMB-2xXP series Housing or C3030WVB,WRB-2xXP Series Wafer
- \*Color:Black

**Ordering Information:**

- C3030HFB-2xXP - \*\*\*
- |   |   |
|---|---|
| 1 | 2 |
|---|---|
- 1.Part No.
  - 2.Material:  
(blank):Nylon 66,UL94V-0  
GWT:Nylon 66,UL94V-0,GWT 750 °C

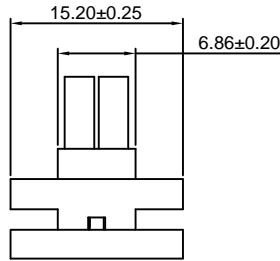
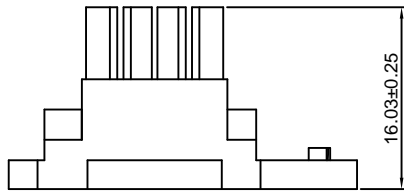
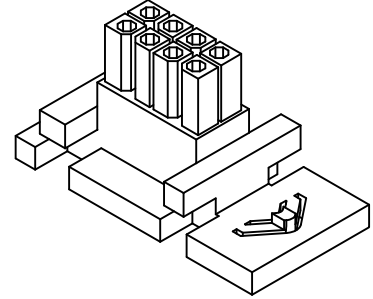
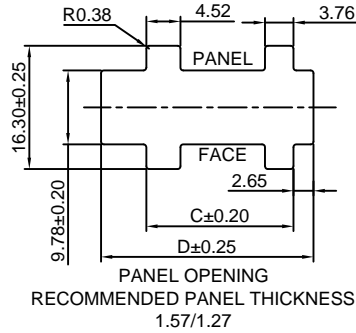
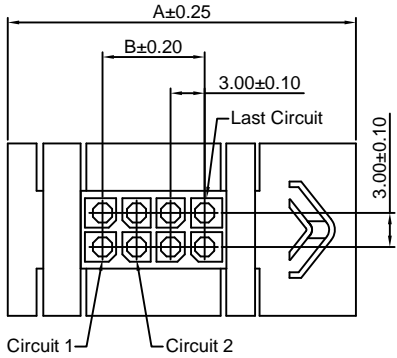

**Ordering Information & Dimensions:**

PART NO.	Dimensions			
	A	B	C	D
2x2P	24.70	3.00	13.46	22.10
2x3P	27.70	6.00	16.46	25.10
2x4P	30.70	9.00	19.46	28.10
2x5P	33.70	12.00	22.46	31.10
2x6P	36.70	15.00	25.46	34.10
2x7P	39.70	18.00	28.46	37.10
2x8P	42.70	21.00	31.46	40.10
2x9P	45.70	24.00	34.46	43.10
2x10P	48.70	27.00	37.46	46.10
2x11P	51.70	30.00	40.46	49.10
2x12P	54.70	33.00	43.46	52.10

Unit: mm

### C3030HMB-2xXP

3.00mm pitch Dual Row Housing

**Reference Informations:**

- \*Material:Nylon 66,UL94V-0
- \*Suitable CJT C3030M-T(-L) series Terminal
- \*Mates with CJT C3030HFB-2xXP series Housing or C3030HFWV,HFWR-2xXP Receptacle Header
- \*Color:Black

**Ordering Information:**

- C3030HMB-2xXP - \*\*\*
- |   |   |
|---|---|
| 1 | 2 |
|---|---|
- 1.Part No.
  - 2.Material:  
(blank):Nylon 66,UL94V-0  
GWT:Nylon 66,UL94V-0,GWT 750 °C

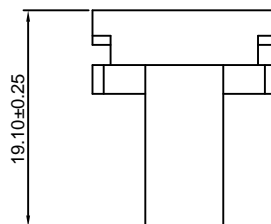
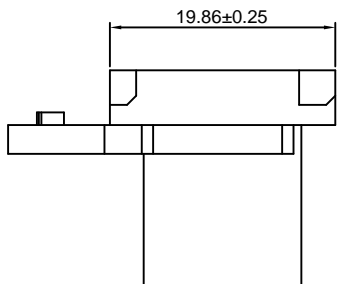
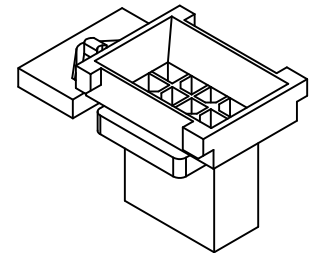
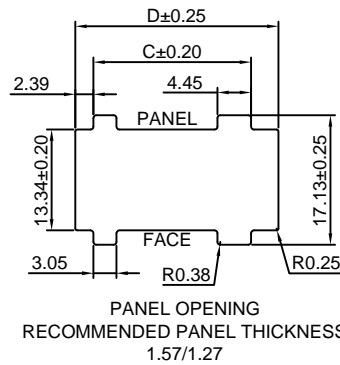
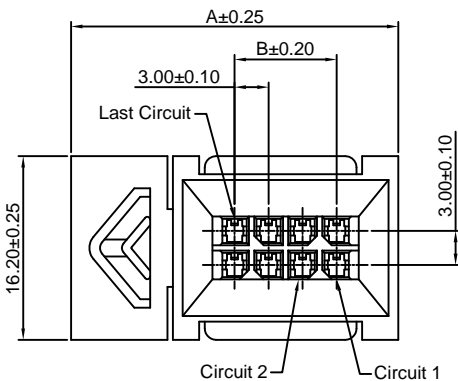

**Ordering Information & Dimensions:**

PART NO.	Dimensions			
	A	B	C	D
2x2P	22.84	3.00	14.85	20.85
2x3P	25.84	6.00	17.85	23.85
2x4P	28.84	9.00	20.85	26.85
2x5P	31.84	12.00	23.85	29.85
2x6P	34.84	15.00	26.85	32.85
2x7P	37.84	18.00	29.85	35.85
2x8P	40.84	21.00	32.85	38.85
2x9P	43.84	24.00	35.85	41.85
2x10P	46.84	27.00	38.85	44.85
2x11P	49.84	30.00	41.85	47.85
2x12P	52.84	33.00	44.85	50.85

Unit: mm

### C3030WV-XP

3.00mm pitch 180° Single Row Wafer

**Reference Informations:**

- \*Material:Pin:Brass/Tin over Nickel  
Insulator:Nylon 66,UL94V-0
- \*Mates with CJT C3030HF-XP,  
C3030HF-2P-A series Housing
- \*Color:Black

**Ordering Information:**

C3030WV-XP - \* - \*\*\* - \*\*\*  
1 2 3 4

- 1.Part No.
- 2.Style:  
(blank):Type 1  
2 :Type 2  
3 :Type 3
- 3.Material:  
(blank):Nylon 66,UL94V-0  
LCP:LCP,UL94V-0  
GWT:LCP,UL94V-0,GWT 750°C
- 4.Finish  
(blank):Tin over Nickel  
G:Gold-flash  
G15:15µm (0.38µm) MIN.Select Gold  
100µm (2.54µm) MIN.Select Tin  
G30:30µm (0.76µm) MIN.Select Gold  
100µm (2.54µm) MIN.Select Tin

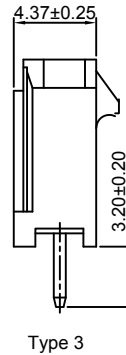
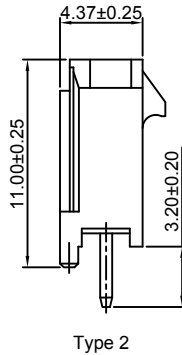
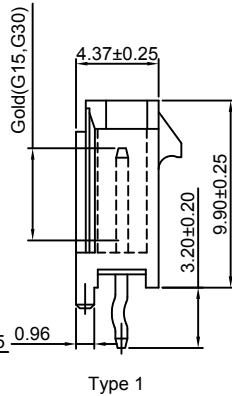
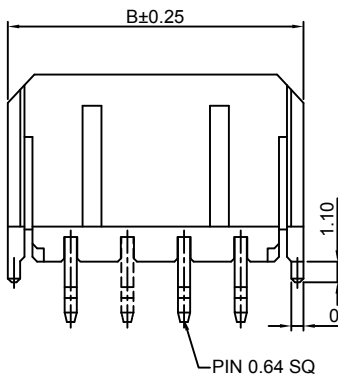
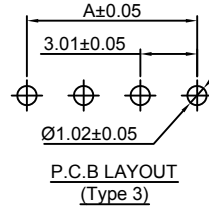
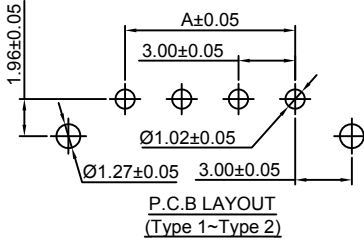
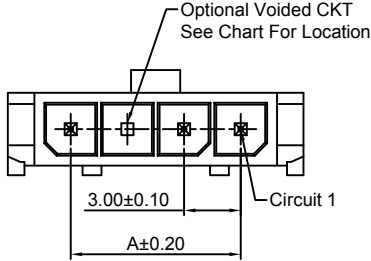
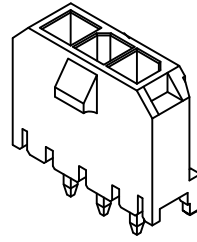

**Ordering Information & Dimensions:**

PART NO.	Dimensions	
	A	B
2P	3.00	9.65
3P	6.00	12.65
4P	9.00	15.65
5P	12.00	18.65
6P	15.00	21.65
7P	18.00	24.65
8P	21.00	27.65
9P	24.00	30.65
10P	27.00	33.65
11P	30.00	36.65
12P	33.00	39.65

Unit: mm

### C3030WR-XP

3.00mm pitch 90° Single Row Wafer

**Reference Informations:**

- \*Material:Pin:Brass/Tin over Nickel  
Insulator:Nylon 66,UL94V-0
- \*Mates with CJT C3030HF-XP,  
C3030HF-2P-A series Housing
- \*Color:Black

**Ordering Information:**

C3030WR-XP - \*\*\* - \*\*\*  
1 2 3

- 1.Part No.
- 2.Material:  
(blank):Nylon 66, UL94V-0  
LCP:LCP,UL94V-0  
GWT:LCP,UL94V-0,GWT 750°C
- 3.Finish  
(blank):Tin over Nickel  
G:Gold-flash  
G15:15µm (0.38µm) MIN.Select Gold  
100µm (2.54µm) MIN.Select Tin  
G30:30µm (0.76µm) MIN.Select Gold  
100µm (2.54µm) MIN.Select Tin

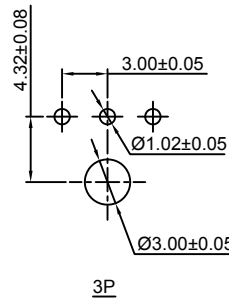
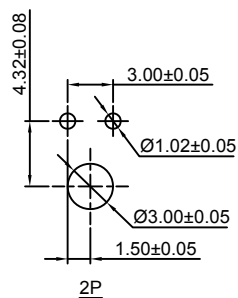
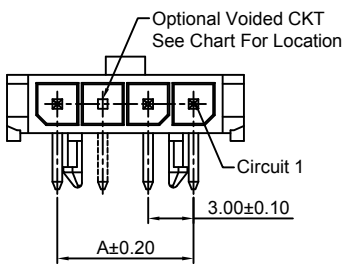
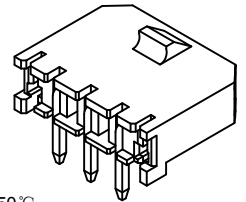

P.C.B LAYOUT

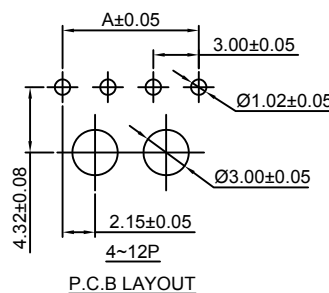
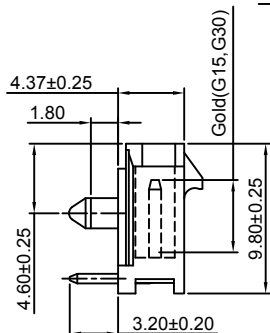
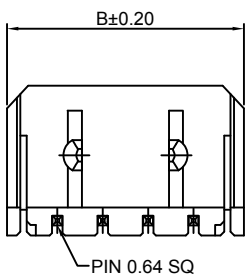

P.C.B LAYOUT

**Ordering Information & Dimensions:**

PART NO.	Dimensions	
	A	B
2P	3.00	9.65
3P	6.00	12.65
4P	9.00	15.65
5P	12.00	18.65
6P	15.00	21.65
7P	18.00	24.65
8P	21.00	27.65
9P	24.00	30.65
10P	27.00	33.65
11P	30.00	36.65
12P	33.00	39.65

Unit: mm

### C3030WV-F-XP

3.00mm pitch 180° Single Row Wafer

#### Reference Informations:

- \*Material: Pin: Brass/Tin over Nickel  
Insulator: Nylon 66, UL94V-0
- \*Mates with CJT C3030HF-XP, C3030HF-2P-A series Housing
- \*Color: Black

#### Ordering Information:

C3030WV-F-XP - \*\*\* - \*\*\*  
1 2 3

- Part No.
- Material:  
(blank): Nylon 66, UL94V-0  
LCP: LCP, UL94V-0  
GWT: LCP, UL94V-0, GWT 750 °C
- Finish  
(blank): Tin over Nickel  
G: Gold-flash  
G15: 15µin (0.38µm) MIN. Select Gold  
100µin (2.54µm) MIN. Select Tin  
G30: 30µin (0.76µm) MIN. Select Gold  
100µin (2.54µm) MIN. Select Tin

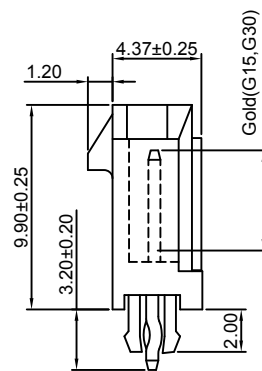
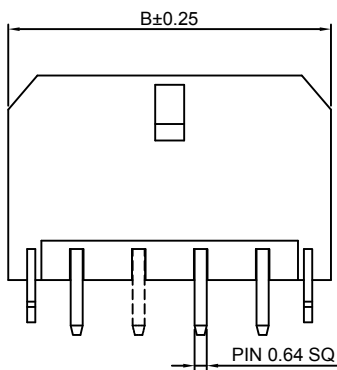
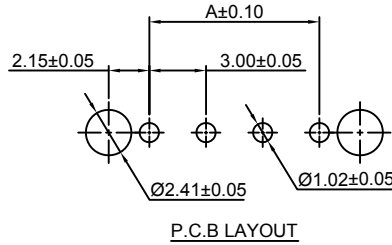
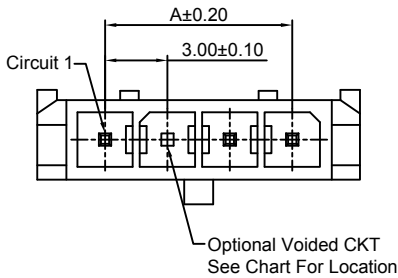

#### Ordering Information & Dimensions:

PART NO.	Dimensions	
	A	B
2P	3.00	9.65
3P	6.00	12.65
4P	9.00	15.65
5P	12.00	18.65
6P	15.00	21.65
7P	18.00	24.65
8P	21.00	27.65
9P	24.00	30.65
10P	27.00	33.65
11P	30.00	36.65
12P	33.00	39.65

Unit: mm

### C3030WR-F-XP

3.00mm pitch 90° Single Row Wafer

#### Reference Informations:

- \*Material: Pin: Brass/Tin over Nickel  
Insulator: Nylon 66, UL94V-0
- \*Mates with CJT C3030HF-XP, C3030HF-2P-A series Housing
- \*Color: Black

#### Ordering Information:

C3030WR-F-XP - \*\*\* - \*\*\*  
1 2 3

- Part No.
- Material:  
(blank): Nylon 66, UL94V-0  
LCP: LCP, UL94V-0  
GWT: LCP, UL94V-0, GWT 750 °C
- Finish  
(blank): Tin over Nickel  
G: Gold-flash  
G15: 15µin (0.38µm) MIN. Select Gold  
100µin (2.54µm) MIN. Select Tin  
G30: 30µin (0.76µm) MIN. Select Gold  
100µin (2.54µm) MIN. Select Tin

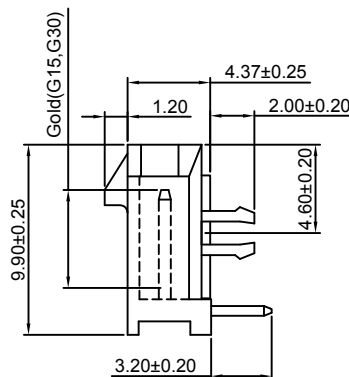
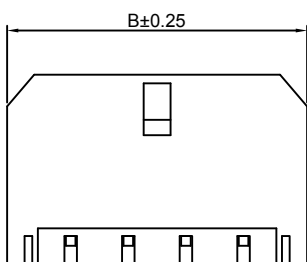
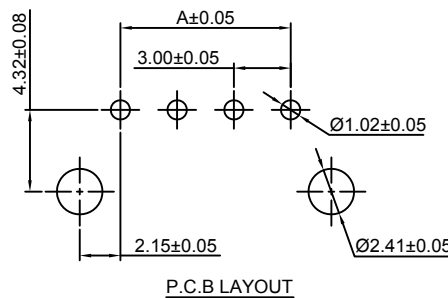
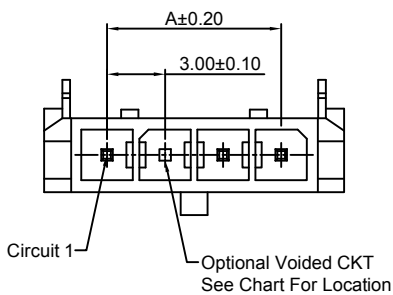

#### Ordering Information & Dimensions:

PART NO.	Dimensions	
	A	B
2P	3.00	9.65
3P	6.00	12.65
4P	9.00	15.65
5P	12.00	18.65
6P	15.00	21.65
7P	18.00	24.65
8P	21.00	27.65
9P	24.00	30.65
10P	27.00	33.65
11P	30.00	36.65
12P	33.00	39.65

Unit: mm

### C3030WV-S-XP

3.00mm pitch 180° Single Row Wafer-SMT TYPE

**Reference Informations:**

- \*Material:Pin:Brass/Tin over Nickel  
Insulator:LCP,UL94V-0
- \*Mates with CJT C3030HF-XP,  
C3030HF-2P-A series Housing
- \*Color:Black

**Ordering Information:**

C3030WV-S-XP - \*\*\* - \*\*\*  
1 2 3

- 1.Part No.
- 2.Material:  
(blank):LCP,UL94V-0  
GWT:LCP,UL94V-0,GWT 750°C
- 3.Finish  
(blank):Tin over Nickel  
G:Gold-flash  
G15:15µin (0.38µm) MIN.Select Gold  
100µin (2.54µm) MIN.Select Tin  
G30:30µin (0.76µm) MIN.Select Gold  
100µin (2.54µm) MIN.Select Tin

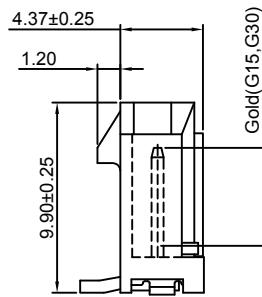
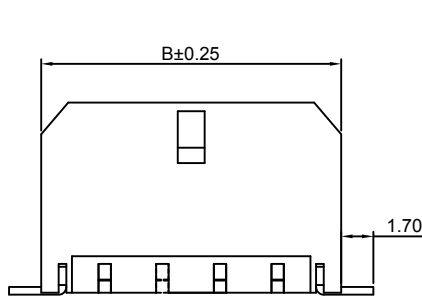
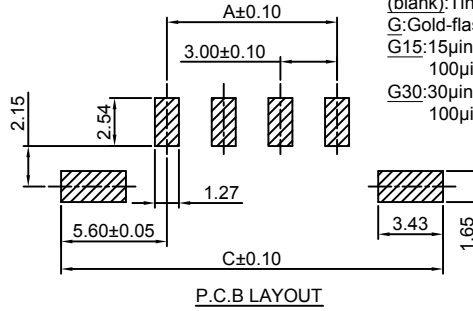
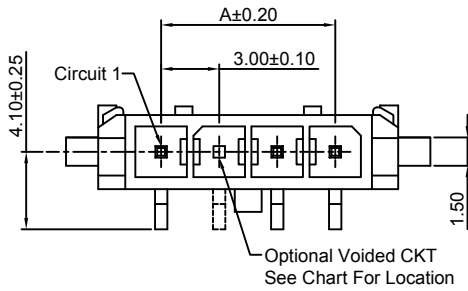
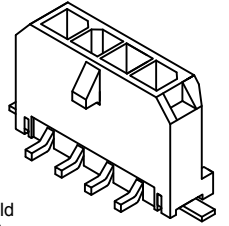

**Ordering Information & Dimensions:**

PART NO.	Dimensions		
	A	B	C
2P	3.00	9.65	14.20
3P	6.00	12.65	17.20
4P	9.00	15.65	20.20
5P	12.00	18.65	23.20
6P	15.00	21.65	26.20
7P	18.00	24.65	29.20
8P	21.00	27.65	32.20
9P	24.00	30.65	35.20
10P	27.00	33.65	38.20
11P	30.00	36.65	41.20
12P	33.00	39.65	44.20

Unit: mm

### C3030WR-S-XP

3.00mm pitch 90° Single Row Wafer-SMT TYPE

**Reference Informations:**

- \*Material:Pin:Brass/Tin over Nickel  
Insulator:LCP,UL94V-0
- \*Mates with CJT C3030HF-XP,  
C3030HF-2P-A series Housing
- \*Color:Black

**Ordering Information:**

C3030WR-S-XP - \*\*\* - \*\*\*  
1 2 3

- 1.Part No.
- 2.Material:  
(blank):LCP,UL94V-0  
GWT:LCP,UL94V-0,GWT 750°C
- 3.Finish  
(blank):Tin over Nickel  
G:Gold-flash  
G15:15µin (0.38µm) MIN.Select Gold  
100µin (2.54µm) MIN.Select Tin  
G30:30µin (0.76µm) MIN.Select Gold  
100µin (2.54µm) MIN.Select Tin

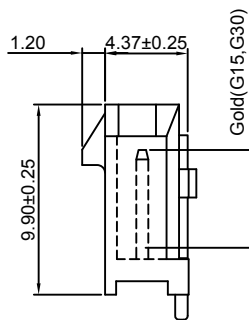
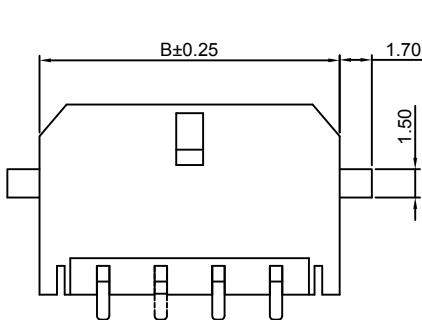
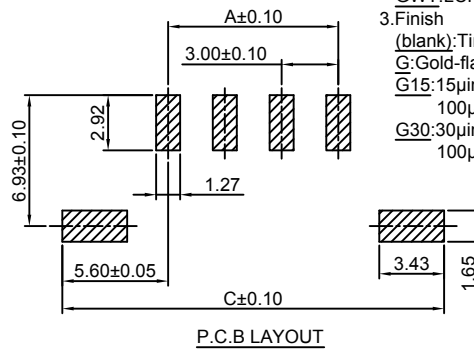
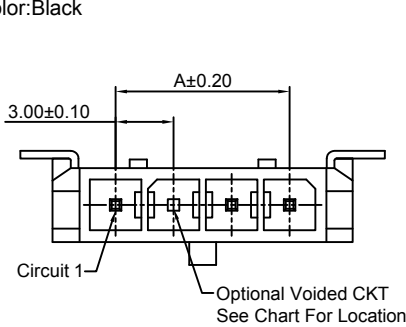
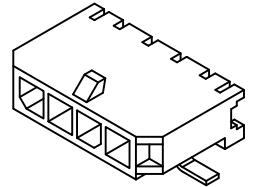

**Ordering Information & Dimensions:**

PART NO.	Dimensions		
	A	B	C
2P	3.00	9.65	14.20
3P	6.00	12.65	17.20
4P	9.00	15.65	20.20
5P	12.00	18.65	23.20
6P	15.00	21.65	26.20
7P	18.00	24.65	29.20
8P	21.00	27.65	32.20
9P	24.00	30.65	35.20
10P	27.00	33.65	38.20
11P	30.00	36.65	41.20
12P	33.00	39.65	44.20

Unit: mm

### C3030WV-S-F-XP

3.00mm pitch 180° Single Row Wafer-SMT TYPE

**Reference Informations:**

\*Material:Pin:Brass/Tin over Nickel  
Insulator:LCP,UL94V-0

\*Mates with CJT C3030HF-XP,  
C3030HF-2P-A series Housing

\*Color:Black

**Ordering Information:**

C3030WV-S-F-XP - \*\*\* - \*\*\*  
1 2 3

1.Part No.

2.Material:

(blank):LCP,UL94V-0

GWT:LCP,UL94V-0,GWT 750 °C

3.Finish

(blank):Tin over Nickel

G:Gold-flash

G15:15µin (0.38µm) MIN.Select Gold

100µin (2.54µm) MIN.Select Tin

G30:30µin (0.76µm) MIN.Select Gold

100µin (2.54µm) MIN.Select Tin

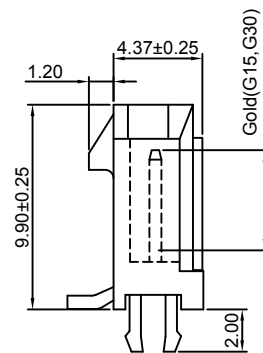
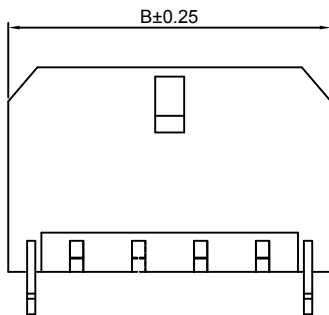
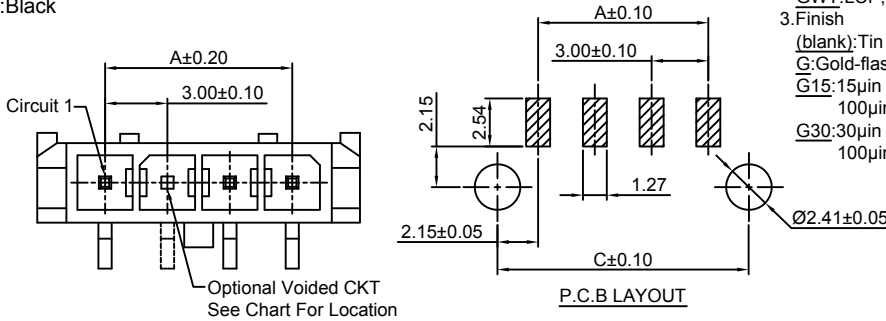
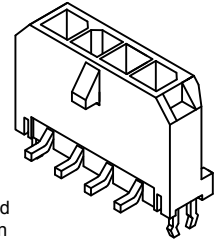

**Ordering Information & Dimensions:**

PART NO.	Dimensions		
	A	B	C
2P	3.00	9.65	7.30
3P	6.00	12.65	10.30
4P	9.00	15.65	13.30
5P	12.00	18.65	16.30
6P	15.00	21.65	19.30
7P	18.00	24.65	22.30
8P	21.00	27.65	25.30
9P	24.00	30.65	28.30
10P	27.00	33.65	31.30
11P	30.00	36.65	34.30
12P	33.00	39.65	37.30

Unit: mm

### C3030WR-S-F-XP

3.00mm pitch 90° Single Row Wafer-SMT TYPE

**Reference Informations:**

\*Material:Pin:Brass/Tin over Nickel  
Insulator:LCP,UL94V-0

\*Mates with CJT C3030HF-XP,  
C3030HF-2P-A series Housing

\*Color:Black

**Ordering Information:**

C3030WR-S-F-XP - \*\*\* - \*\*\*  
1 2 3

1.Part No.

2.Material:

(blank):LCP,UL94V-0

GWT:LCP,UL94V-0,GWT 750 °C

3.Finish

(blank):Tin over Nickel

G:Gold-flash

G15:15µin (0.38µm) MIN.Select Gold

100µin (2.54µm) MIN.Select Tin

G30:30µin (0.76µm) MIN.Select Gold

100µin (2.54µm) MIN.Select Tin

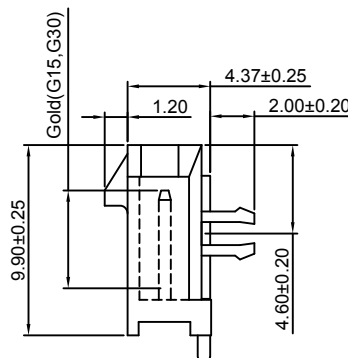
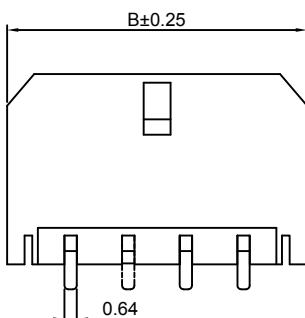
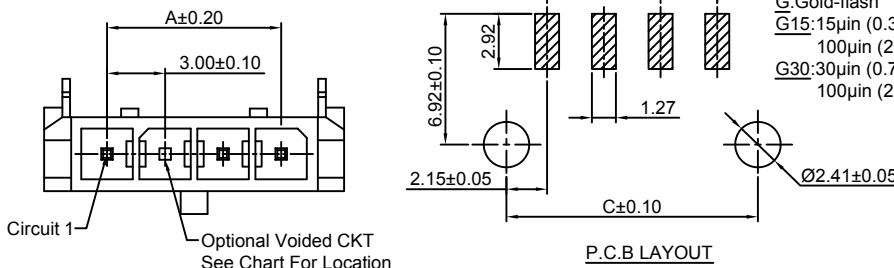
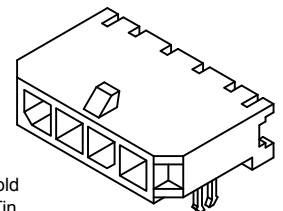

**Ordering Information & Dimensions:**

PART NO.	Dimensions		
	A	B	C
2P	3.00	9.65	7.30
3P	6.00	12.65	10.30
4P	9.00	15.65	13.30
5P	12.00	18.65	16.30
6P	15.00	21.65	19.30
7P	18.00	24.65	22.30
8P	21.00	27.65	25.30
9P	24.00	30.65	28.30
10P	27.00	33.65	31.30
11P	30.00	36.65	34.30
12P	33.00	39.65	37.30

Unit: mm



### C3030WV-2xXP

3.00mm pitch 180° Dual Row Wafer

#### Reference Informations:

- \*Material: Pin: Brass/Tin over Nickel  
Insulator: Nylon 66, UL94V-0
- \*Mates with CJT C3030HF-2xXP, C3030HF-2xXP-A series Housing
- \*Color: Black

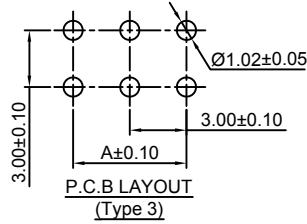
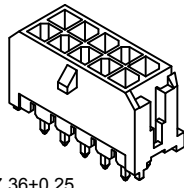
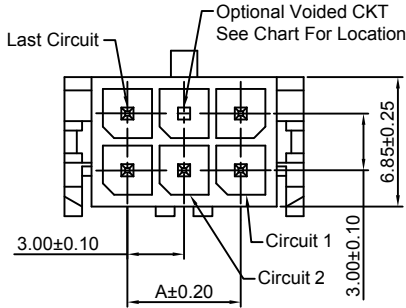

Ordering Information:  
C3030WV-2xXP - \* - \*\*\* - \*\*\*  
1 2 3 4

1. Part No.
2. Style:  
(blank) : Type 1  
2 : Type 2
3. Material:  
(blank) : Nylon 66, UL94V-0  
LCP: LCP, UL94V-0  
GWT: LCP, UL94V-0, GWT 750°C
4. Finish  
(blank) : Tin over Nickel  
G: Gold-flash  
G15: 15µm (0.38µm) MIN. Select Gold  
100µm (2.54µm) MIN. Select Tin  
G30: 30µm (0.76µm) MIN. Select Gold  
100µm (2.54µm) MIN. Select Tin

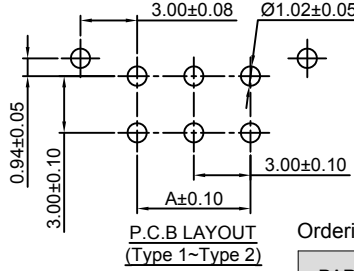
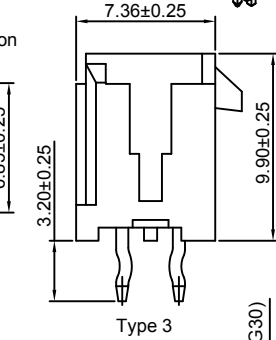
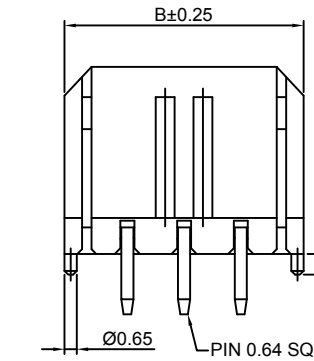

Ordering Information & Dimensions:

PART NO.	Dimensions	
	A	B
2x1P	----	6.65
2x2P	3.00	9.65
2x3P	6.00	12.65
2x4P	9.00	15.65
2x5P	12.00	18.65
2x6P	15.00	21.65
2x7P	18.00	24.65
2x8P	21.00	27.65
2x9P	24.00	30.65
2x10P	27.00	33.65
2x11P	30.00	36.65
2x12P	33.00	39.65

Unit: mm

### C3030WR-2xXP

3.00mm pitch 90° Dual Row Wafer With Foot

#### Reference Informations:

- \*Material: Pin: Brass/Tin over Nickel  
Insulator: Nylon 66, UL94V-0
- \*Mates with CJT C3030HF-2xXP, C3030HF-2xXP-A series Housing
- \*Color: Black

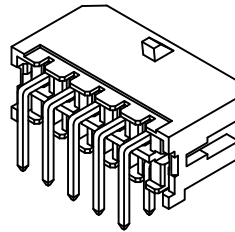
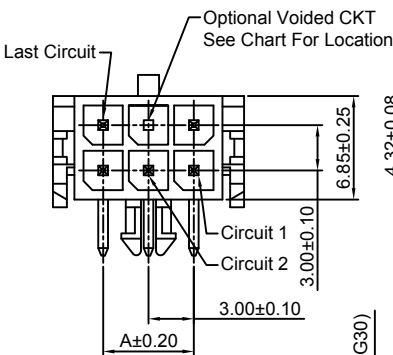

Ordering Information:  
C3030WR-2xXP - \*\*\* - \*\*\*  
1 2 3

1. Part No.
2. Material:  
(blank) : Nylon 66, UL94V-0  
LCP: LCP, UL94V-0  
GWT: LCP, UL94V-0, GWT 750°C
3. Finish  
(blank) : Tin over Nickel  
G: Gold-flash  
G15: 15µm (0.38µm) MIN. Select Gold  
100µm (2.54µm) MIN. Select Tin  
G30: 30µm (0.76µm) MIN. Select Gold  
100µm (2.54µm) MIN. Select Tin

Ordering Information & Dimensions:

PART NO.	Dimensions	
	A	B
2x1P	----	6.85
2x2P	3.00	9.85
2x3P	6.00	12.85
2x4P	9.00	15.85
2x5P	12.00	18.85
2x6P	15.00	21.85
2x7P	18.00	24.85
2x8P	21.00	27.85
2x9P	24.00	30.85
2x10P	27.00	33.85
2x11P	30.00	36.85
2x12P	33.00	39.85

Unit: mm

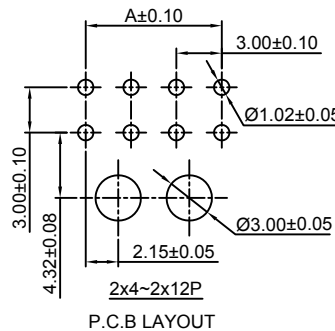
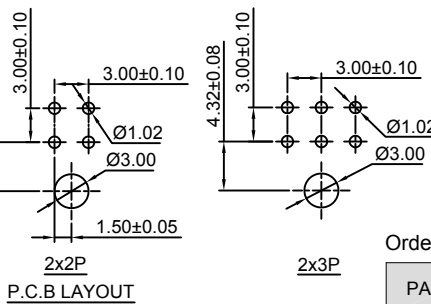
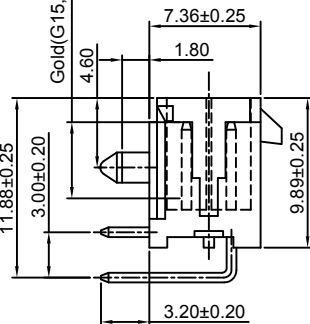
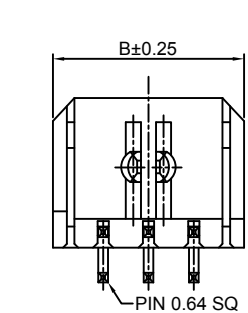

### C3030WVC-2xXP

3.00mm pitch Dual Row 180° Compliant Pin Interface Wafer

#### Reference Informations:

- \*Material: Pin: Brass/Tin over Nickel  
Insulator: LCP, UL94V-0
- \*Mates with CJT C3030HF-2xXP, C3030HF-2xXP-A series Housing
- \*Color: Black

#### Ordering Information:

C3030WVC-2xXP - \*\*\* - \*\*\*  
1 2 3

- Part No.
- Material:  
(blank): LCP, UL94V-0  
GWT: LCP, UL94V-0, GWT 750 °C
- Finish  
(blank): Tin over Nickel  
G: Gold-flash  
G15: 15µin (0.38µm) MIN. Select Gold  
100µin (2.54µm) MIN. Select Tin  
G30: 30µin (0.76µm) MIN. Select Gold  
100µin (2.54µm) MIN. Select Tin

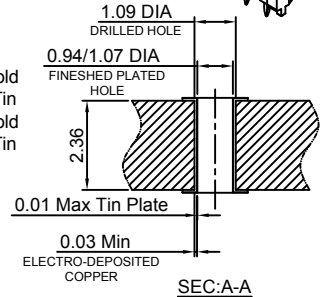
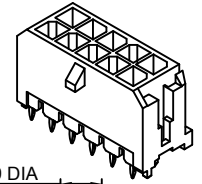

#### Ordering Information & Dimensions:

PART NO.	Dimensions	
	A	B
2x1P	---	6.65
2x2P	3.00	9.65
2x3P	6.00	12.65
2x4P	9.00	15.65
2x5P	12.00	18.65
2x6P	15.00	21.65
2x7P	18.00	24.65
2x8P	21.00	27.65
2x9P	24.00	30.65
2x10P	27.00	33.65
2x11P	30.00	36.65
2x12P	33.00	39.65

Unit: mm

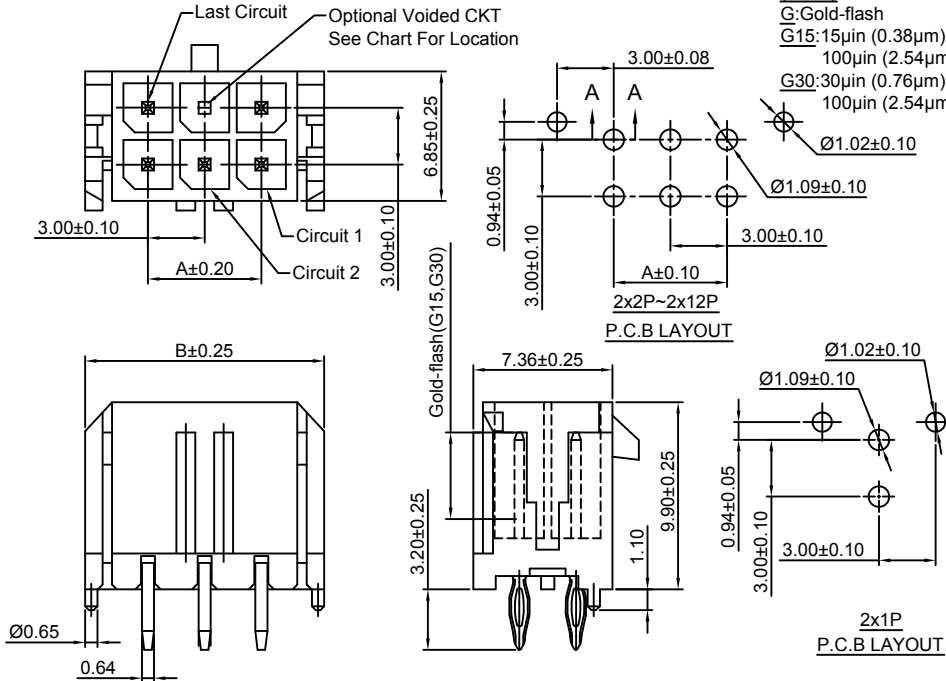

### C3030WV-S-2xXP

3.00mm pitch 180° Dual Row Wafer-SMT TYPE

#### Reference Informations:

- \*Material: Pin: Brass/Tin over Nickel  
Insulator: LCP, UL94V-0
- \*Mates with CJT C3030HF-2xXP, C3030HF-2xXP-A series Housing
- \*Color: Black

#### Ordering Information:

C3030WV-S-2xXP - \*\*\* - \*\*\*  
1 2 3

- Part No.
- Material:  
(blank): LCP, UL94V-0  
GWT: LCP, UL94V-0, GWT 750 °C
- Finish  
(blank): Tin over Nickel  
G: Gold-flash  
G15: 15µin (0.38µm) MIN. Select Gold  
100µin (2.54µm) MIN. Select Tin  
G30: 30µin (0.76µm) MIN. Select Gold  
100µin (2.54µm) MIN. Select Tin

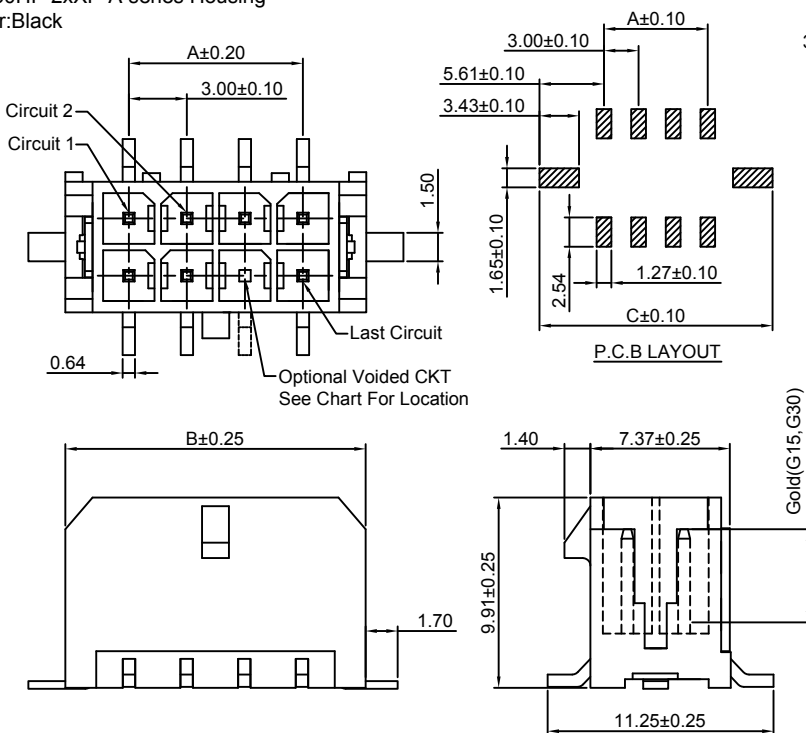
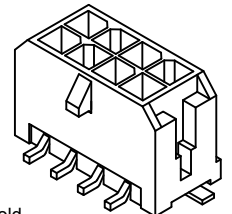

PART NO.	Dimensions		
	A	B	C
2x1P	---	6.65	11.20
2x2P	3.00	9.65	14.20
2x3P	6.00	12.65	17.20
2x4P	9.00	15.65	20.20
2x5P	12.00	18.65	23.20
2x6P	15.00	21.65	26.20
2x7P	18.00	24.65	29.20
2x8P	21.00	27.65	32.20
2x9P	24.00	30.65	35.20
2x10P	27.00	33.65	38.20
2x11P	30.00	36.65	41.20
2x12P	33.00	39.65	44.20

Unit: mm

### C3030WR-S-2xXP

3.00mm pitch 90° Dual Row Wafer-SMT TYPE

#### Reference Informations:

- \*Material: Pin: Brass/Tin over Nickel  
Insulator: LCP, UL94V-0
- \*Mates with CJT C3030HF-2xXP,  
C3030HF-2xXP-A series Housing
- \*Color: Black

Ordering Information:  
C3030WR-S-2xXP - \*\*\* - \*\*\*  
1 2 3

1. Part No.
2. Material:  
(blank): LCP, UL94V-0  
GWT: LCP, UL94V-0, GWT 750 °C
3. Finish  
(blank): Tin over Nickel  
G: Gold-flash  
G15: 15µin (0.38µm) MIN. Select Gold  
100µin (2.54µm) MIN. Select Tin  
G30: 30µin (0.76µm) MIN. Select Gold  
100µin (2.54µm) MIN. Select Tin

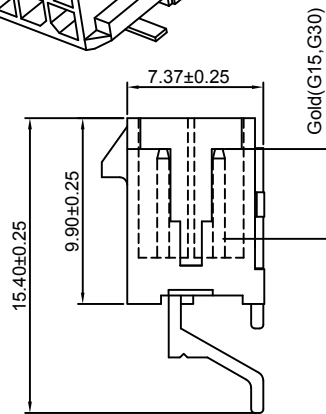
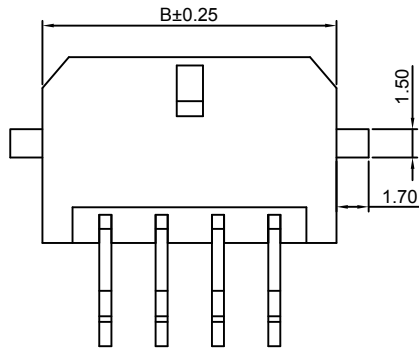
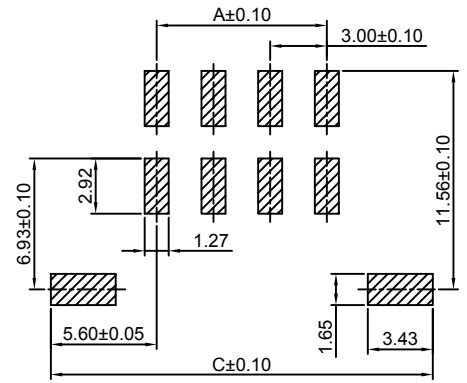
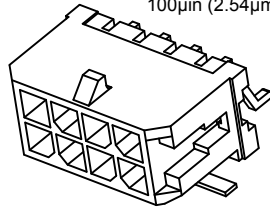
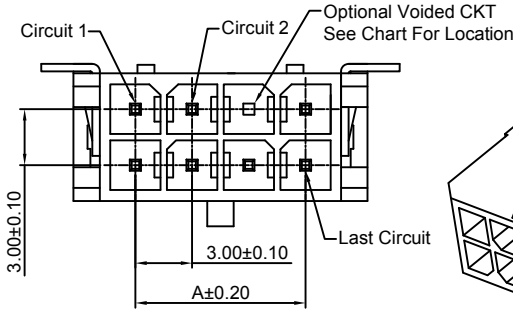

#### Ordering Information & Dimensions:

PART NO.	Dimensions		
	A	B	C
2x1P	----	6.65	11.20
2x2P	3.00	9.65	14.20
2x3P	6.00	12.65	17.20
2x4P	9.00	15.65	20.20
2x5P	12.00	18.65	23.20
2x6P	15.00	21.65	26.20
2x7P	18.00	24.65	29.20
2x8P	21.00	27.65	32.20
2x9P	24.00	30.65	35.20
2x10P	27.00	33.65	38.20
2x11P	30.00	36.65	41.20
2x12P	33.00	39.65	44.20

Unit: mm

### C3030WV-F-2xXP

3.00mm pitch 180° Dual Row Wafer With Foot

#### Reference Informations:

- \*Material: Pin: Brass/Tin over Nickel  
Insulator: Nylon 66, UL94V-0
- \*Mates with CJT C3030HF-2xXP,  
C3030HF-2xXP-A series Housing
- \*Color: Black

Ordering Information:  
C3030WV-F-2xXP - \*\*\* - \*\*\*  
1 2 3

1. Part No.
2. Material:  
(blank): Nylon 66, UL94V-0  
LCP: LCP, UL94V-0  
GWT: LCP, UL94V-0, GWT 750 °C
3. Finish  
(blank): Tin over Nickel  
G: Gold-flash  
G15: 15µin (0.38µm) MIN. Select Gold  
100µin (2.54µm) MIN. Select Tin  
G30: 30µin (0.76µm) MIN. Select Gold  
100µin (2.54µm) MIN. Select Tin

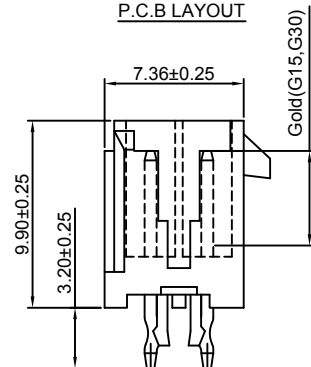
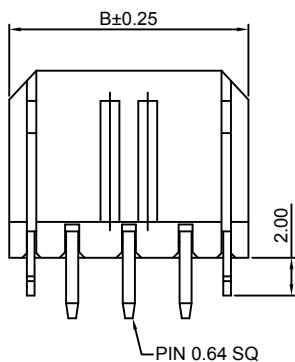
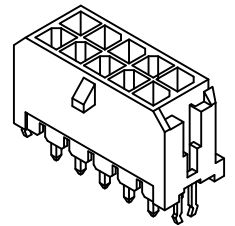
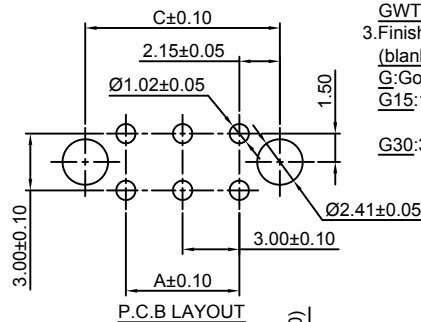
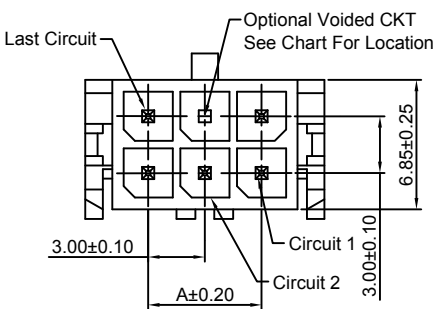

#### Ordering Information & Dimensions:

PART NO.	Dimensions		
	A	B	C
2x1P	----	6.65	4.30
2x2P	3.00	9.65	7.30
2x3P	6.00	12.65	10.30
2x4P	9.00	15.65	13.30
2x5P	12.00	18.65	16.30
2x6P	15.00	21.65	19.30
2x7P	18.00	24.65	22.30
2x8P	21.00	27.65	25.30
2x9P	24.00	30.65	28.30
2x10P	27.00	33.65	31.30
2x11P	30.00	36.65	34.30
2x12P	33.00	39.65	37.30

Unit: mm

### C3030WR-F-2xXP

3.00mm pitch 90° Dual Row Wafer With Foot

**Reference Informations:**

- \*Material: Pin: Brass/Tin over Nickel  
Insulator: Nylon 66, UL94V-0
- \*Mates with CJT C3030HF-2xXP, C3030HF-2xXP-A series Housing
- \*Color: Black

**Ordering Information:**

C3030WR-F-2xXP - \*\*\* - \*\*\*  
1 2 3

- Part No.
- Material:  
(blank): Nylon 66, UL94V-0  
LCP: LCP, UL94V-0  
GWT: LCP, UL94V-0, GWT 750°C
- Finish  
(blank): Tin over Nickel  
G: Gold-flash  
G15: 15µin (0.38µm) MIN. Select Gold  
100µin (2.54µm) MIN. Select Tin  
G30: 30µin (0.76µm) MIN. Select Gold  
100µin (2.54µm) MIN. Select Tin

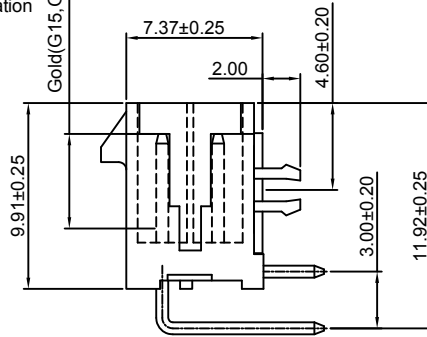
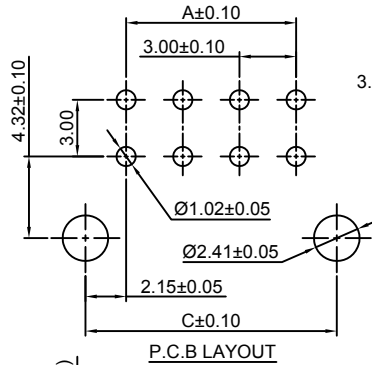
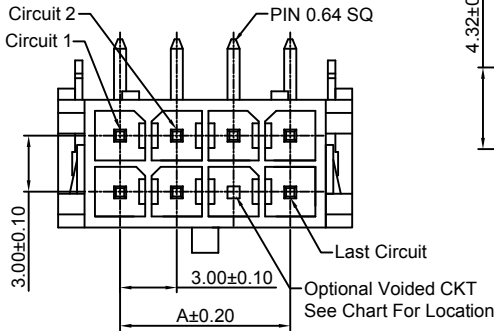
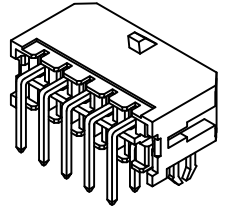

**Ordering Information & Dimensions:**

PART NO.	Dimensions		
	A	B	C
2x1P	----	6.65	4.30
2x2P	3.00	9.65	7.30
2x3P	6.00	12.65	10.30
2x4P	9.00	15.65	13.30
2x5P	12.00	18.65	16.30
2x6P	15.00	21.65	19.30
2x7P	18.00	24.65	22.30
2x8P	21.00	27.65	25.30
2x9P	24.00	30.65	28.30
2x10P	27.00	33.65	31.30
2x11P	30.00	36.65	34.30
2x12P	33.00	39.65	37.30

Unit: mm

### C3030WV-S-F-2xXP

3.00mm pitch 180° Dual Row Wafer-SMT TYPE

**Reference Informations:**

- \*Material: Pin: Brass/Tin over Nickel  
Insulator: LCP, UL94V-0
- \*Mates with CJT C3030HF-2xXP, C3030HF-2xXP-A series Housing
- \*Color: Black

**Ordering Information:**

C3030WV-S-F-2xXP - \*\*\* - \*\*\*  
1 2 3

- Part No.
- Material:  
(blank): LCP, UL94V-0  
GWT: LCP, UL94V-0, GWT 750°C
- Finish  
(blank): Tin over Nickel  
G: Gold-flash  
G15: 15µin (0.38µm) MIN. Select Gold  
100µin (2.54µm) MIN. Select Tin  
G30: 30µin (0.76µm) MIN. Select Gold  
100µin (2.54µm) MIN. Select Tin

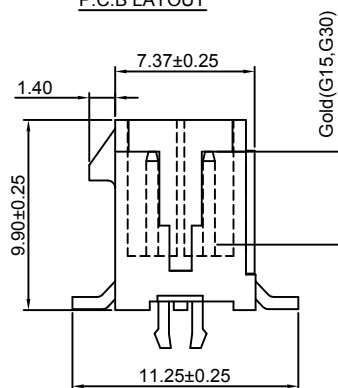
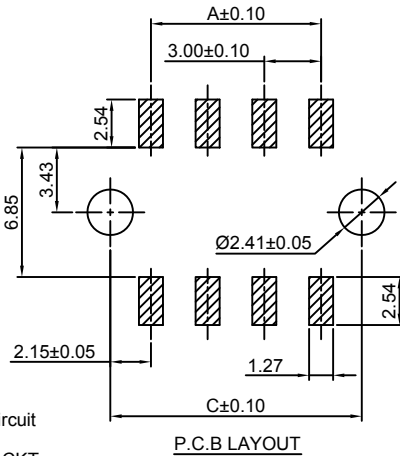
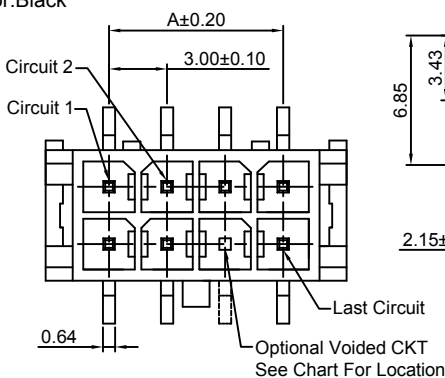
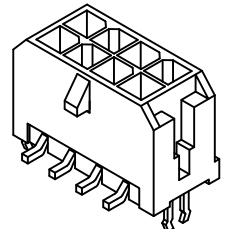

**Ordering Information & Dimensions:**

PART NO.	Dimensions		
	A	B	C
2x1P	----	6.65	4.30
2x2P	3.00	9.65	7.30
2x3P	6.00	12.65	10.30
2x4P	9.00	15.65	13.30
2x5P	12.00	18.65	16.30
2x6P	15.00	21.65	19.30
2x7P	18.00	24.65	22.30
2x8P	21.00	27.65	25.30
2x9P	24.00	30.65	28.30
2x10P	27.00	33.65	31.30
2x11P	30.00	36.65	34.30
2x12P	33.00	39.65	37.30

Unit: mm

### C3030WR-S-F-2xXP

3.00mm pitch 90° Dual Row Wafer-SMT TYPE

#### Reference Informations:

- \*Material: Pin: Brass/Tin over Nickel  
Insulator: LCP, UL94V-0
- \*Mates with CJT C3030HF-2xXP, C3030HF-2xXP-A series Housing
- \*Color: Black

#### Ordering Information:

C3030WR-S-F-2xXP - \*\*\* - \*\*\*  
1 2 3

1. Part No.
2. Material:  
(blank): LCP, UL94V-0  
GWT: LCP, UL94V-0, GWT 750°C
3. Finish  
(blank): Tin over Nickel  
G: Gold-flash  
G15: 15µin (0.38µm) MIN. Select Gold  
100µin (2.54µm) MIN. Select Tin  
G30: 30µin (0.76µm) MIN. Select Gold  
100µin (2.54µm) MIN. Select Tin

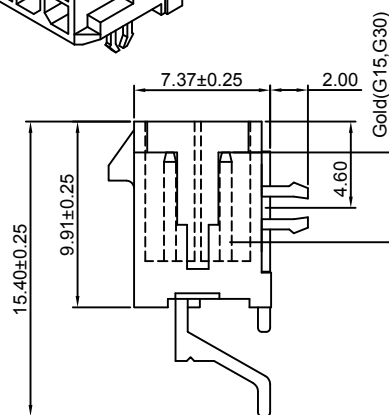
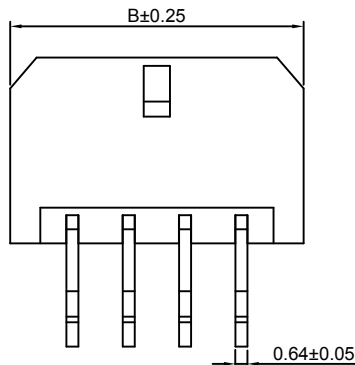
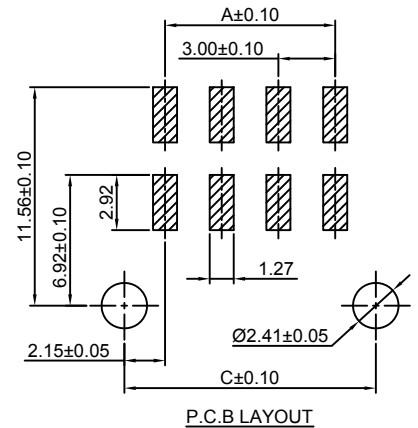
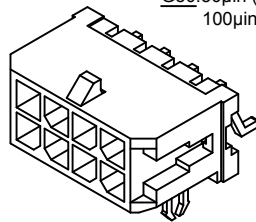
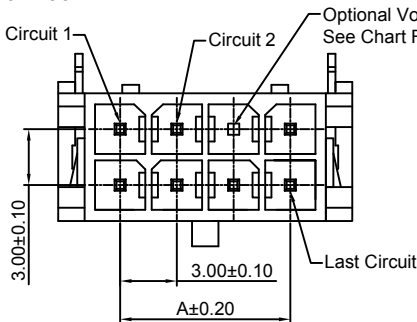

#### Ordering Information & Dimensions:

PART NO.	Dimensions		
	A	B	C
2x1P	---	6.65	4.30
2x2P	3.00	9.65	7.30
2x3P	6.00	12.65	10.30
2x4P	9.00	15.65	13.30
2x5P	12.00	18.65	16.30
2x6P	15.00	21.65	19.30
2x7P	18.00	24.65	22.30
2x8P	21.00	27.65	25.30
2x9P	24.00	30.65	28.30
2x10P	27.00	33.65	31.30
2x11P	30.00	36.65	34.30
2x12P	33.00	39.65	37.30

Unit: mm

### C3030WR-S-F1-2xXP

3.00mm pitch 90° Dual Row Wafer-SMT TYPE

#### Reference Informations:

- \*Material: Pin: Brass/Tin over Nickel  
Insulator: LCP, UL94V-0
- \*Mates with CJT C3030HF-2xXP, C3030HF-2xXP-A series Housing
- \*Color: Black

Ordering Information:  
C3030WR-S-F1-2xXP - \*\*\* - \*\*\*  
1 2 3

1. Part No.
2. Material:  
(blank): LCP, UL94V-0  
GWT: LCP, UL94V-0, GWT 750°C
3. Finish  
(blank): Tin over Nickel  
G: Gold-flash  
G15: 15µin (0.38µm) MIN. Select Gold  
100µin (2.54µm) MIN. Select Tin  
G30: 30µin (0.76µm) MIN. Select Gold  
100µin (2.54µm) MIN. Select Tin

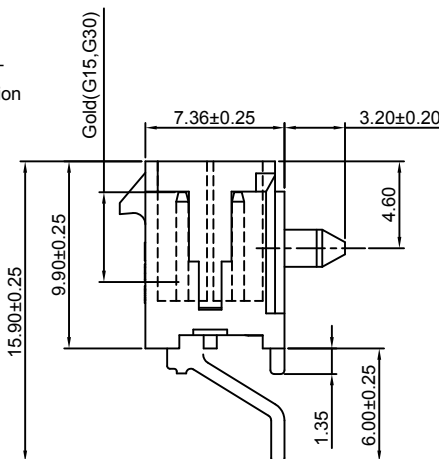
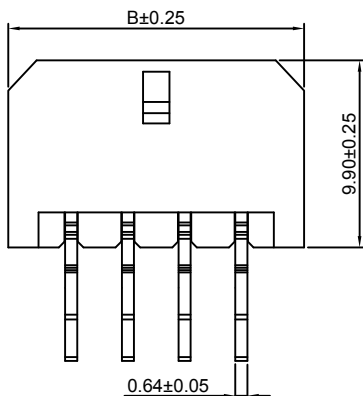
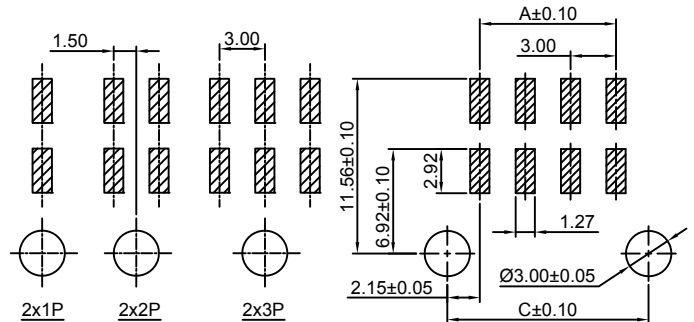
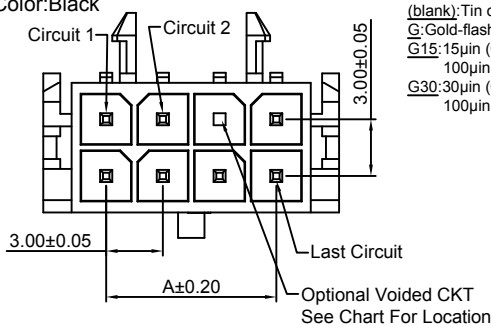

PART NO.	Dimensions		
	A	B	C
2x1P	---	6.65	4.30
2x2P	3.00	9.65	7.30
2x3P	6.00	12.65	10.30
2x4P	9.00	15.65	13.30
2x5P	12.00	18.65	16.30
2x6P	15.00	21.65	19.30
2x7P	18.00	24.65	22.30
2x8P	21.00	27.65	25.30
2x9P	24.00	30.65	28.30
2x10P	27.00	33.65	31.30
2x11P	30.00	36.65	34.30
2x12P	33.00	39.65	37.30

Unit: mm

### C3030WVA-2xXP

3.00mm pitch 180° Dual Row Wafer

#### Reference Informations:

- \*Material: Pin: Brass/Tin over Nickel  
Insulator: Nylon 66, UL94V-0
- \*Mates with CJT C3030HF-2xXP, C3030HF-2xXP-A series Housing
- \*Color: Black

#### Ordering Information:

C3030WVA-2xXP - <sup>\*</sup> - <sup>\*\*\*</sup> - <sup>\*\*\*</sup>  
1 2 3 4

1. Part No.
2. Style:  
(blank): Type 1  
3: Type 3
3. Material:  
(blank): Nylon 66, UL94V-0  
GWT: Nylon 66, UL94V-0, GWT 750°C
4. Finish:  
(blank): Tin over Nickel  
G: Gold-flash  
G15: 15µm (0.38µm) MIN. Select Gold  
100µm (2.54µm) MIN. Select Tin  
G30: 30µm (0.76µm) MIN. Select Gold  
100µm (2.54µm) MIN. Select Tin

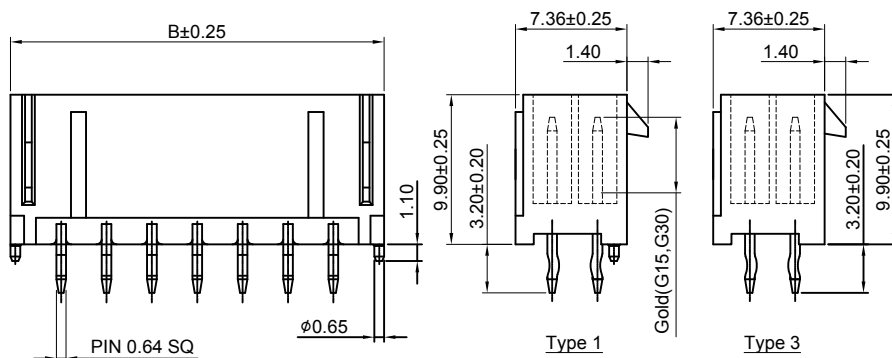
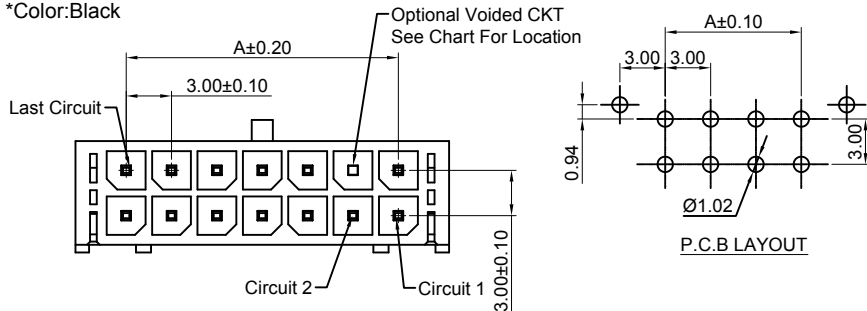
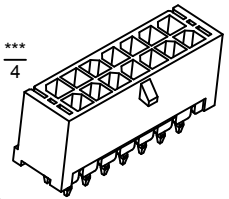

#### Ordering Information & Dimensions:

PART NO.	Dimensions	
	A	B
2x1P	----	6.70
2x2P	3.00	9.70
2x3P	6.00	12.70
2x4P	9.00	15.70
2x5P	12.00	18.70
2x6P	15.00	21.70
2x7P	18.00	24.70
2x8P	21.00	27.70
2x9P	24.00	30.70
2x10P	27.00	33.70
2x11P	30.00	36.70
2x12P	33.00	39.70

Unit: mm

### C3030WVA-S-2xXP

3.00mm pitch 180° Dual Row Wafer - SMT TYPE

#### Reference Informations:

- \*Material: Pin: Brass/Tin over Nickel  
Insulator: LCP, UL94V-0
- \*Mates with CJT C3030HF-2xXP, C3030HF-2xXP-A series Housing
- \*Color: Black

#### Ordering Information:

C3030WVA-S-2xXP - <sup>\*\*\*</sup> - <sup>\*\*\*</sup>  
1 2 3

1. Part No.
2. Material:  
(blank): LCP, UL94V-0  
GWT: LCP, UL94V-0, GWT 750°C
3. Finish:  
(blank): Tin over Nickel  
G: Gold-flash  
G15: 15µm (0.38µm) MIN. Select Gold  
100µm (2.54µm) MIN. Select Tin  
G30: 30µm (0.76µm) MIN. Select Gold  
100µm (2.54µm) MIN. Select Tin

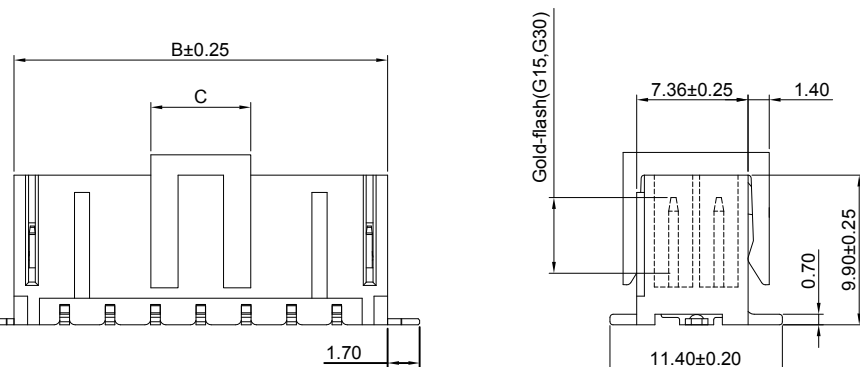
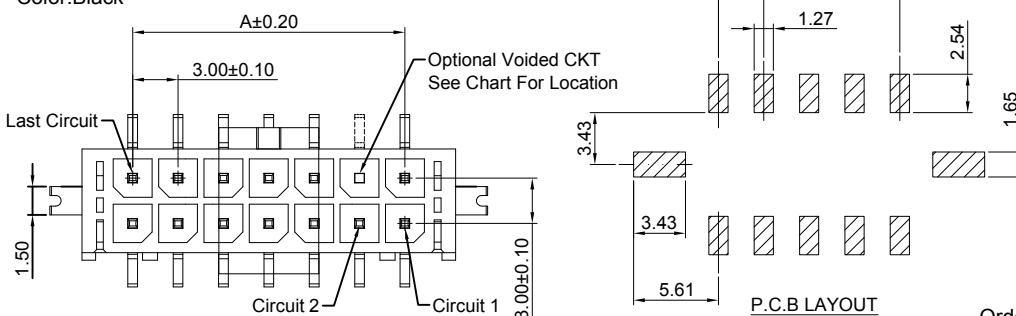

#### Ordering Information & Dimensions:

PART NO.	Dimensions		
	A	B	C
2x1P	----	6.70	6.60
2x2P	3.00	9.70	6.60
2x3P	6.00	12.70	6.60
2x4P	9.00	15.70	6.60
2x5P	12.00	18.70	6.60
2x6P	15.00	21.70	6.60
2x7P	18.00	24.70	6.60
2x8P	21.00	27.70	12.00
2x9P	24.00	30.70	12.00
2x10P	27.00	33.70	12.00
2x11P	30.00	36.70	12.00
2x12P	33.00	39.70	12.00

Unit: mm

### C3030WVA-F-2xXP

3.00mm pitch 180° Dual Row Wafer

#### Reference Informations:

- \*Material: Pin: Brass/Tin over Nickel  
Insulator: LCP, UL94V-0
- \*Mates with CJT C3030HF-2xXP, C3030HF-2xXP-A series Housing
- \*Color: Black

Ordering Information:  
C3030WVA-F-2xXP - <sup>\*\*\*</sup>/<sub>2</sub> - <sup>\*\*\*</sup>/<sub>3</sub>

- Part No.
- Material:  
(blank): LCP, UL94V-0  
GWT: LCP, UL94V-0, GWT 750°C
- Finish  
(blank): Tin over Nickel  
G: Gold-flash  
G15: 15µm (0.38µm) MIN. Select Gold  
100µm (2.54µm) MIN. Select Tin  
G30: 30µm (0.76µm) MIN. Select Gold  
100µm (2.54µm) MIN. Select Tin

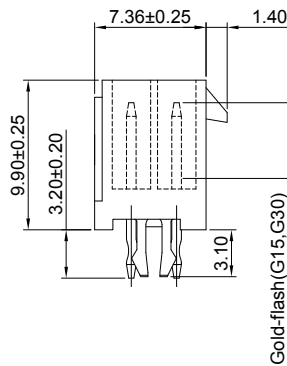
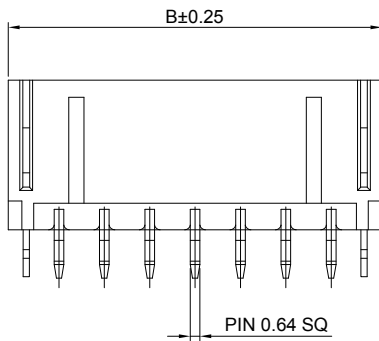
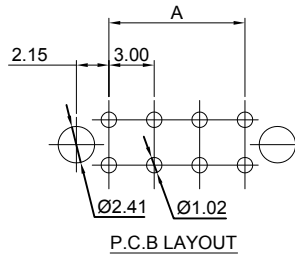
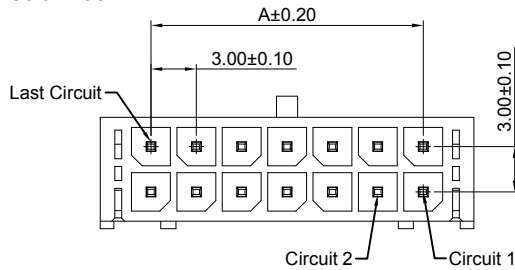

#### Ordering Information & Dimensions:

PART NO.	Dimensions	
	A	B
2x1P	----	6.70
2x2P	3.00	9.70
2x3P	6.00	12.70
2x4P	9.00	15.70
2x5P	12.00	18.70
2x6P	15.00	21.70
2x7P	18.00	24.70
2x8P	21.00	27.70
2x9P	24.00	30.70
2x10P	27.00	33.70
2x11P	30.00	36.70
2x12P	33.00	39.70

Unit: mm

### C3030WVA-S-F-2xXP

3.00mm pitch 180° Dual Row Wafer - SMT TYPE

#### Reference Informations:

- \*Material: Pin: Brass/Tin over Nickel  
Insulator: LCP, UL94V-0
- \*Mates with CJT C3030HF-2xXP, C3030HF-2xXP-A series Housing
- \*Color: Black

Ordering Information:  
C3030WVA-S-F-2xXP - <sup>\*\*\*</sup>/<sub>2</sub> - <sup>\*\*\*</sup>/<sub>3</sub>

- Part No.
- Material:  
(blank): LCP, UL94V-0  
GWT: LCP, UL94V-0, GWT 750°C
- Finish  
(blank): Tin over Nickel  
G: Gold-flash  
G15: 15µm (0.38µm) MIN. Select Gold  
100µm (2.54µm) MIN. Select Tin  
G30: 30µm (0.76µm) MIN. Select Gold  
100µm (2.54µm) MIN. Select Tin

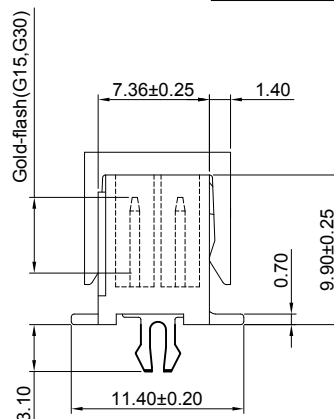
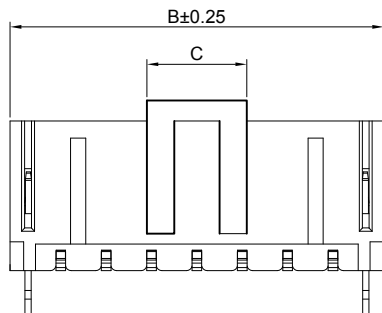
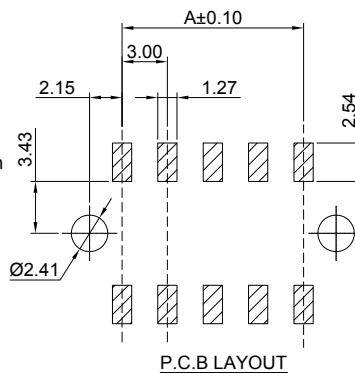
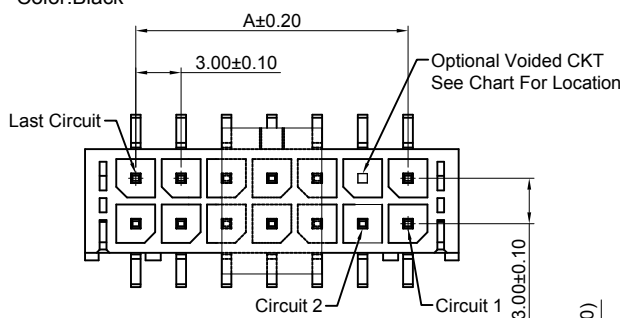

#### Ordering Information & Dimensions:

PART NO.	Dimensions		
	A	B	C
2x1P	----	6.70	6.60
2x2P	3.00	9.70	6.60
2x3P	6.00	12.70	6.60
2x4P	9.00	15.70	6.60
2x5P	12.00	18.70	6.60
2x6P	15.00	21.70	6.60
2x7P	18.00	24.70	6.60
2x8P	21.00	27.70	12.00
2x9P	24.00	30.70	12.00
2x10P	27.00	33.70	12.00
2x11P	30.00	36.70	12.00
2x12P	33.00	39.70	12.00

Unit: mm

### C3030WRA-F-2xXP

3.00mm pitch 90° Dual Row Wafer

#### Reference Informations:

- \*Material: Pin: Brass/Tin over Nickel  
Insulator: Nylon 66, UL94V-0
- \*Mates with CJT C3030HF-2xXP, C3030HF-2xXP-A series Housing
- \*Color: Black

Ordering Information:  
C3030WRA-F-2xXP - <sup>\*\*\*</sup>/<sub>2</sub> - <sup>\*\*\*</sup>/<sub>3</sub>

1. Part No.
2. Material:  
(blank): Nylon 66, UL94V-0  
GWT: Nylon 66, UL94V-0, GWT 750°C
3. Finish  
(blank): Tin over Nickel  
G: Gold-flash  
G15: 15µin (0.38µm) MIN. Select Gold  
100µin (2.54µm) MIN. Select Tin  
G30: 30µin (0.76µm) MIN. Select Gold  
100µin (2.54µm) MIN. Select Tin

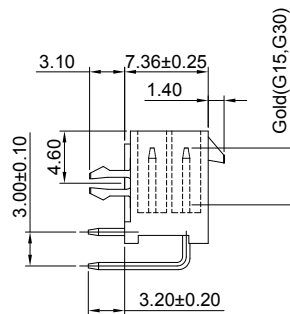
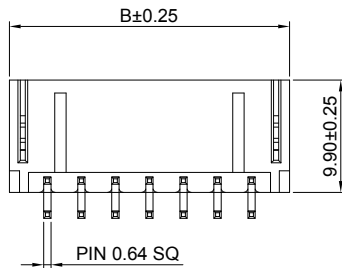
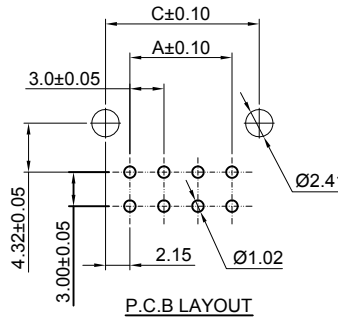
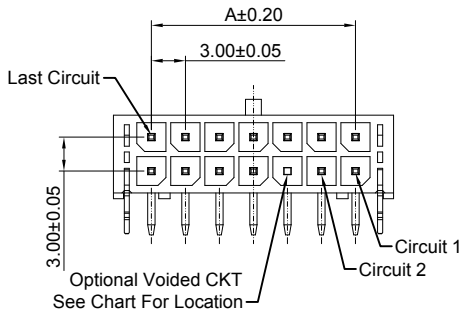

#### Ordering Information & Dimensions:

PART NO.	Dimensions		
	A	B	C
2x1P	----	6.65	4.30
2x2P	3.00	9.65	7.30
2x3P	6.00	12.65	10.30
2x4P	9.00	15.65	13.30
2x5P	12.00	18.65	16.30
2x6P	15.00	21.65	19.30
2x7P	18.00	24.65	22.30
2x8P	21.00	27.65	25.30
2x9P	24.00	30.65	28.30
2x10P	27.00	33.65	31.30
2x11P	30.00	36.65	34.30
2x12P	33.00	39.65	37.30

Unit: mm

### C3030WRA-F1-2xXP

3.00mm pitch 90° Dual Row Wafer

#### Reference Informations:

- \*Material: Pin: Brass/Tin over Nickel  
Insulator: Nylon 66, UL94V-0
- \*Mates with CJT C3030HF-2xXP, C3030HF-2xXP-A series Housing
- \*Color: Black

Ordering Information:  
C3030WRA-F1-2xXP - <sup>\*\*\*</sup>/<sub>2</sub> - <sup>\*\*\*</sup>/<sub>3</sub>

1. Part No.
2. Material:  
(blank): Nylon 66, UL94V-0  
GWT: Nylon 66, UL94V-0, GWT 750°C
3. Finish  
(blank): Tin over Nickel  
G: Gold-flash  
G15: 15µin (0.38µm) MIN. Select Gold  
100µin (2.54µm) MIN. Select Tin  
G30: 30µin (0.76µm) MIN. Select Gold  
100µin (2.54µm) MIN. Select Tin

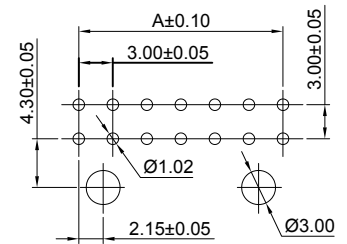
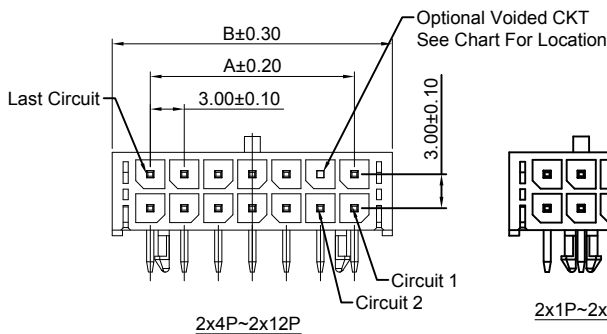

P.C.B LAYOUT  
2x4P~2x12P

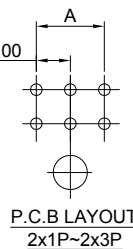
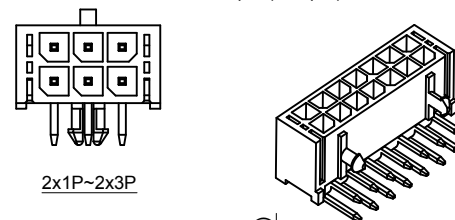
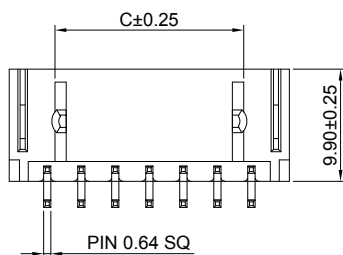

P.C.B LAYOUT  
2x1P~2x3P

#### Ordering Information & Dimensions:

PART NO.	Dimensions		
	A	B	C
2x1P	----	6.65	2.90
2x2P	3.00	9.65	2.90
2x3P	6.00	12.65	2.90
2x4P	9.00	15.65	7.60
2x5P	12.00	18.65	10.60
2x6P	15.00	21.65	13.60
2x7P	18.00	24.65	16.60
2x8P	21.00	27.65	19.60
2x9P	24.00	30.65	22.60
2x10P	27.00	33.65	25.60
2x11P	30.00	36.65	28.60
2x12P	33.00	39.65	31.60

Unit: mm



### C3030WRA-S-2xXP

3.00mm pitch 90° Dual Row Wafer - SMT TYPE

**Reference Informations:**

- \*Material: Pin: Brass/Tin over Nickel  
Insulator: LCP, UL94V-0
- \*Mates with CJT C3030HF-2xXP, C3030HF-2xXP-A series Housing
- \*Color: Black

**Ordering Information:**

C3030WRA-S-2xXP - \*\*\* - \*\*\*  
1 2 3

- Part No.
- Material:  
(blank): LCP, UL94V-0  
GWT: LCP, UL94V-0, GWT 750°C
- Finish  
(blank): Tin over Nickel  
G: Gold-flash  
G15: 15µin (0.38µm) MIN. Select Gold  
100µin (2.54µm) MIN. Select Tin  
G30: 30µin (0.76µm) MIN. Select Gold  
100µin (2.54µm) MIN. Select Tin

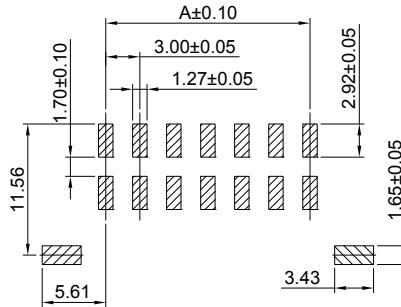
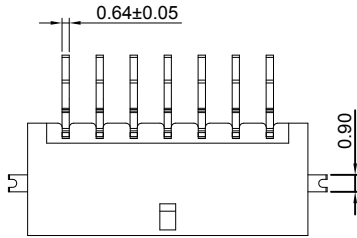

P.C.B LAYOUT

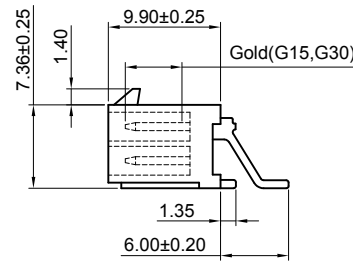
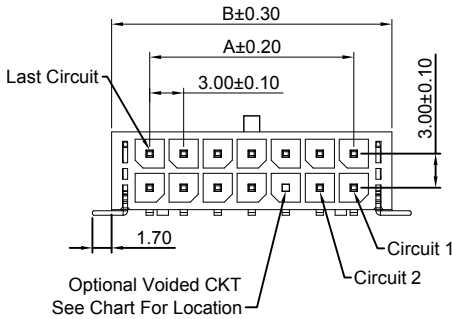

**Ordering Information & Dimensions:**

PART NO.	Dimensions	
	A	B
2x1P	----	6.70
2x2P	3.00	9.70
2x3P	6.00	12.70
2x4P	9.00	15.70
2x5P	12.00	18.70
2x6P	15.00	21.70
2x7P	18.00	24.70
2x8P	21.00	27.70
2x9P	24.00	30.70
2x10P	27.00	33.70
2x11P	30.00	36.70
2x12P	33.00	39.70

Unit: mm

### C3030WRA-S-F-2xXP

3.00mm pitch 90° Dual Row Wafer - SMT TYPE

**Reference Informations:**

- \*Material: Pin: Brass/Tin over Nickel  
Insulator: LCP, UL94V-0
- \*Mates with CJT C3030HF-2xXP, C3030HF-2xXP-A series Housing
- \*Color: Black

**Ordering Information:**

C3030WRA-S-F-2xXP - \*\*\* - \*\*\*  
1 2 3

- Part No.
- Material:  
(blank): LCP, UL94V-0  
GWT: LCP, UL94V-0, GWT 750°C
- Finish  
(blank): Tin over Nickel  
G: Gold-flash  
G15: 15µin (0.38µm) MIN. Select Gold  
100µin (2.54µm) MIN. Select Tin  
G30: 30µin (0.76µm) MIN. Select Gold  
100µin (2.54µm) MIN. Select Tin

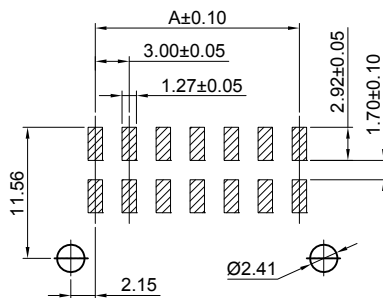
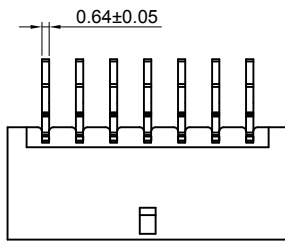

P.C.B LAYOUT

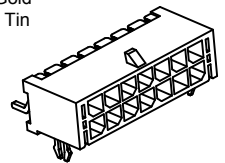
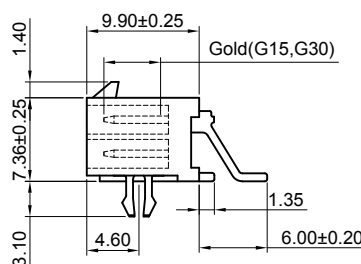
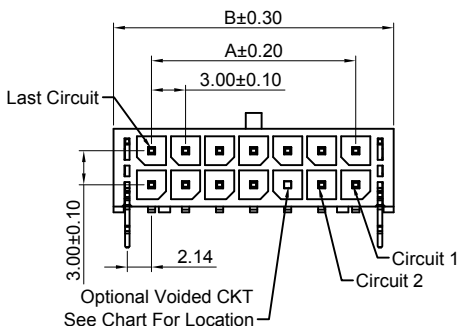

**Ordering Information & Dimensions:**

PART NO.	Dimensions	
	A	B
2x1P	----	6.70
2x2P	3.00	9.70
2x3P	6.00	12.70
2x4P	9.00	15.70
2x5P	12.00	18.70
2x6P	15.00	21.70
2x7P	18.00	24.70
2x8P	21.00	27.70
2x9P	24.00	30.70
2x10P	27.00	33.70
2x11P	30.00	36.70
2x12P	33.00	39.70

Unit: mm

### C3030WRA-S-F1-2xXP

3.00mm pitch 90° Dual Row Wafer - SMT TYPE

#### Reference Informations:

- \*Material: Pin: Brass/Tin over Nickel  
Insulator: LCP, UL94V-0
- \*Mates with CJT C3030HF-2xXP, C3030HF-2xXP-A series Housing
- \*Color: Black

#### Ordering Information:

C3030WRA-S-F1-2xXP - \*\*\* - \*\*\*  
1 2 3

1. Part No.
2. Material:  
(blank): LCP, UL94V-0  
GWT: LCP, UL94V-0, GWT 750°C
3. Finish  
(blank): Tin over Nickel  
G: Gold-flash  
G15: 15µm (0.38µm) MIN. Select Gold  
100µm (2.54µm) MIN. Select Tin  
G30: 30µm (0.76µm) MIN. Select Gold  
100µm (2.54µm) MIN. Select Tin

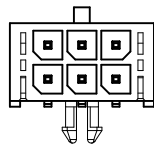
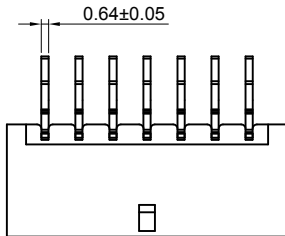

2x1P~2x3P

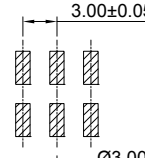

P.C.B LAYOUT  
(2x1P~2x3P)

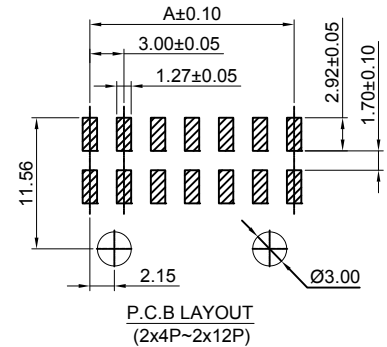

P.C.B LAYOUT  
(2x4P~2x12P)

#### Ordering Information & Dimensions:

PART NO.	Dimensions	
	A	B
2x1P	---	6.70
2x2P	3.00	9.70
2x3P	6.00	12.70
2x4P	9.00	15.70
2x5P	12.00	18.70
2x6P	15.00	21.70
2x7P	18.00	24.70
2x8P	21.00	27.70
2x9P	24.00	30.70
2x10P	27.00	33.70
2x11P	30.00	36.70
2x12P	33.00	39.70

Unit: mm

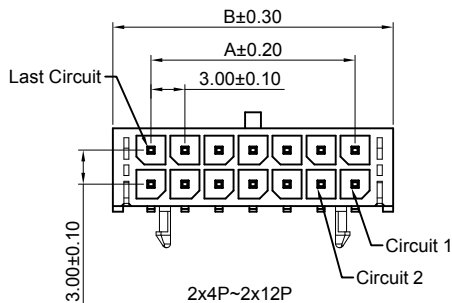

2x4P~2x12P

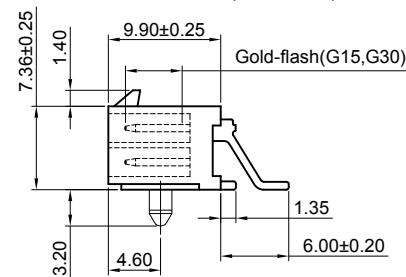

### C3030HFWV-2xXP

3.00mm pitch Dual Row Receptacle Header

#### Reference Informations:

- \*Material: LCP, UL94V-0
- \*Mates with CJT C3030HMB-2xXP series Housing or C3030WVB, WRB-2xXP Series Wafer
- \*Color: Black

#### Ordering Information:

C3030HFWV-2xXP - \*\*\* - \*\*\*  
1 2 3

1. Part No.
2. Material:  
(blank): LCP, UL94V-0  
GWT: LCP, UL94V-0, GWT 750°C
3. Finish:  
(blank): Tin over Nickel  
G: Gold-flash  
G15: 15µm (0.38µm) MIN. Select Gold  
100µm (2.54µm) MIN. Select Tin  
G30: 30µm (0.76µm) MIN. Select Gold  
100µm (2.54µm) MIN. Select Tin

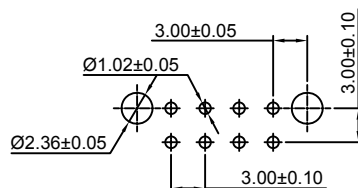
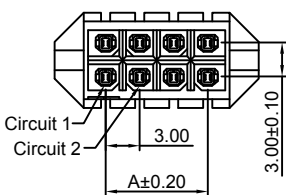

P.C.B LAYOUT

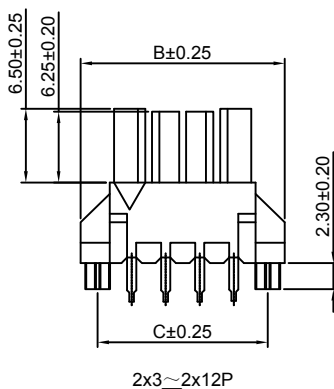
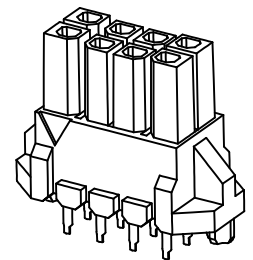

2x3~2x12P

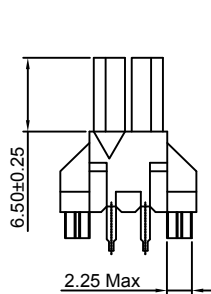

2x2P

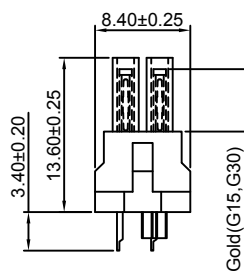

#### Ordering Information & Dimensions:

PART NO.	Dimensions		
	A	B	C
2x2P	3.00	12.00	9.00
2x3P	6.00	15.00	12.00
2x4P	9.00	18.00	15.00
2x5P	12.00	21.00	18.00
2x6P	15.00	24.00	21.00
2x7P	18.00	27.00	24.00
2x8P	21.00	30.00	27.00
2x9P	24.00	33.00	30.00
2x10P	27.00	36.00	33.00
2x11P	30.00	39.00	36.00
2x12P	33.00	42.00	39.00

Unit: mm

### C3030HFWR-2xXP

3.00mm pitch Dual Row Receptacle Header

**Reference Informations:**

- \*Material:LCP,UL94V-0
- \*Mates with CJT C3030HMB-2xXP series Housing or C3030WVB,WRB-2xXP Series Wafer
- \*Color:Black

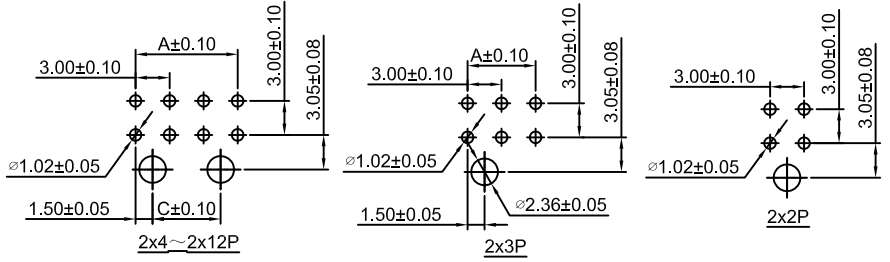

Ordering Information:

C3030HFWR-2xXP - \*\*\* - \*\*\*  
1 2 3

- Part No.
- Material:  
(blank):LCP,UL94V-0  
GWT:LCP,UL94V-0,GWT 750°C
- Finish:  
(blank):Tin over Nickel  
G:Gold-flash  
G15:15µin (0.38µm) MIN.Select Gold  
100µin (2.54µm) MIN.Select Tin  
G30:30µin (0.76µm) MIN.Select Gold  
100µin (2.54µm) MIN.Select Tin

P.C.B LAYOUT

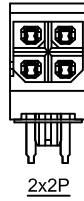
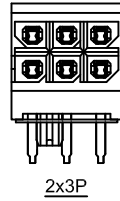
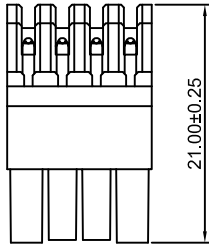
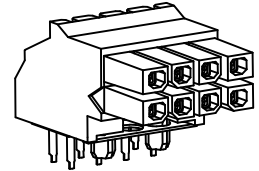

**Ordering Information & Dimensions:**

PART NO.	Dimensions		
	A	B	C
2x2P	3.00	6.70	----
2x3P	6.00	9.70	----
2x4P	9.00	12.70	6.00
2x5P	12.00	15.70	9.00
2x6P	15.00	18.70	12.00
2x7P	18.00	21.70	15.00
2x8P	21.00	24.70	18.00
2x9P	24.00	27.70	21.00
2x10P	27.00	30.70	24.00
2x11P	30.00	33.70	27.00
2x12P	33.00	36.70	30.00

Unit: mm

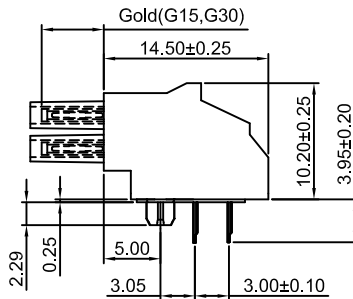
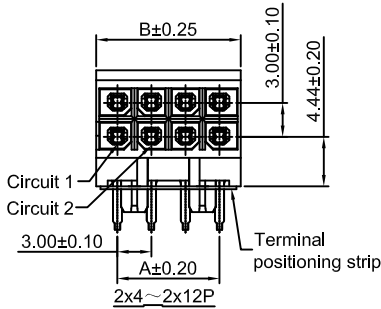

### C3030WVB-2xXP

3.00mm pitch Dual Row 180° Wafer

**Reference Informations:**

- \*Material:Pin:Brass/Tin over Nickel  
Insulator:LCP,UL94-V0
- \*Mates with CJT C3030HFB-2xXP Series Housing or C3030HFVW,HFWR-2xXP Receptacle Header
- \*Color:Black

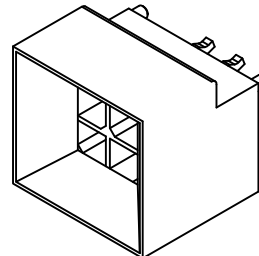

Ordering Information:

C3030WVB-2xXP - \*\*\* - \*\*\*  
1 2 3

- Part No.
- Material:  
(blank): LCP,UL94V-0  
6T: Nylon 6T,UL94V-0  
9T: Nylon 9T,UL94V-0
- Finish:  
(blank): Tin over Nickel  
G: Gold-flash  
G15: 15µin (0.38µm) MIN.Select Gold  
100µin (2.54µm) MIN.Select Tin  
G30: 30µin (0.76µm) MIN.Select Gold  
100µin (2.54µm) MIN.Select Tin

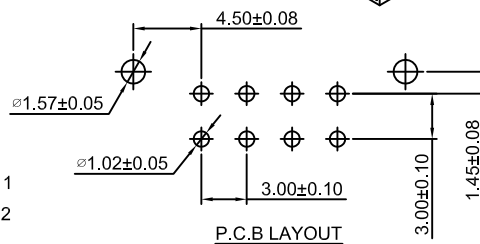
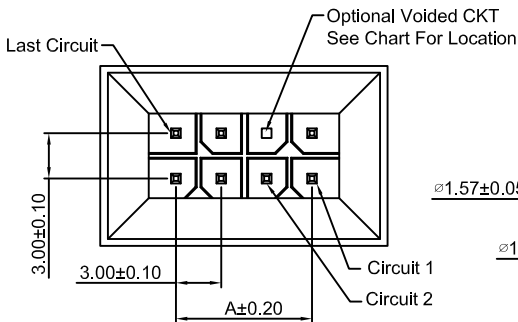

P.C.B LAYOUT

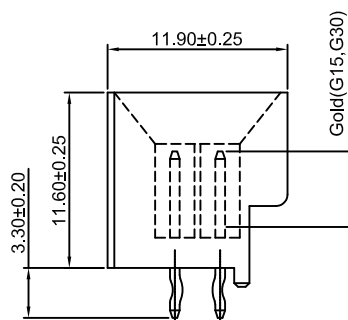
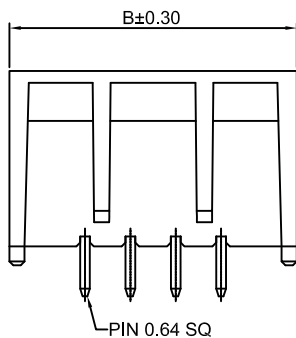

**Ordering Information & Dimensions:**

PART NO.	Dimensions	
	A	B
2x2P	3.00	13.00
2x3P	6.00	16.00
2x4P	9.00	19.00
2x5P	12.00	22.00
2x6P	15.00	25.00
2x7P	18.00	28.00
2x8P	21.00	31.00
2x9P	24.00	34.00
2x10P	27.00	37.00
2x11P	30.00	40.00
2x12P	33.00	43.00

Unit: mm

