

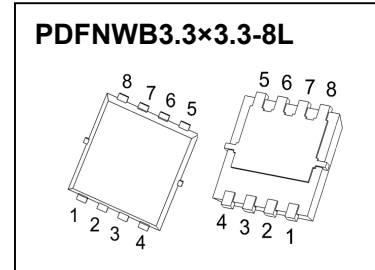

**JIANGSU CHANGJING ELECTRONICS TECHNOLOGY CO., LTD**  
**PDFNWB3.3×3.3-8L Plastic-Encapsulate MOSFETS**

**CJAB55P03A P-Channel Power MOSFET**

$V_{(BR)DSS}$	$R_{DS(on)TYP}$	$I_D$
-30V	6.5mΩ@-10V	-55A
	8.4mΩ@-4.5V	



**DESCRIPTION**

The CJAB55P03A uses advanced trench technology and design to provide excellent  $R_{DS(ON)}$  with low gate charge. It can be used in a wide variety of applications

**FEATURES**

- High density cell design for ultra low  $R_{DS(ON)}$
- Fully characterized avalanche voltage and current
- Excellent package for good heat dissipation
- Special process technology for high ESD capability

**APPLICATIONS**

- Battery and loading switching

**MARKING**

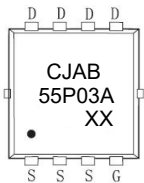

CJAB55P03A = Part No.  
 Solid dot=Pin1 indicator.  
 XX=Code.

**EQUIVALENT CIRCUIT**

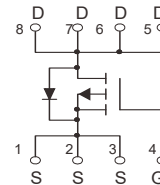

**MAXIMUM RATINGS (  $T_a=25^\circ\text{C}$  unless otherwise noted )**

Parameter	Symbol	Limit	Unit
Drain-Source Voltage	$V_{DS}$	-30	V
Gate-Source Voltage	$V_{GS}$	±20	V
Continuous Drain Current	$I_D$ ①	-55	A
Pulsed Drain Current	$I_{DM}$ ②	-200	A
Single Pulsed Avalanche Energy	$E_{AS}$ ③	150	mJ
Power Dissipation	$P_D$ ①	50	W
Thermal Resistance from Junction to Ambient	$R_{\theta JA}$ ⑥	83.3	°CW
Thermal Resistance from Junction to Case	$R_{\theta JC}$ ①	2.5	°CW
Operating Junction and Storage Temperature Range	$T_J, T_{stg}$	-55~+150	°C

# MOSFET ELECTRICAL CHARACTERISTICS

$T_a=25^\circ\text{C}$  unless otherwise specified

Parameter	Symbol	Test Condition	Min	Typ	Max	Unit
<b>Off characteristics</b>						
Drain-source breakdown voltage	$V_{(BR)DSS}$	$V_{GS} = 0V, I_D = -1mA$	-30			V
Zero gate voltage drain current	$I_{DSS}$	$V_{DS} = -24V, V_{GS} = 0V$	$T_J = 25^\circ\text{C}$		-1.0	$\mu\text{A}$
			$T_J = 125^\circ\text{C}$		-100	
Gate-body leakage current	$I_{GSS}$	$V_{DS} = 0V, V_{GS} = \pm 20V$			$\pm 100$	nA
<b>On characteristics</b> <sup>④</sup>						
Gate-threshold voltage	$V_{GS(th)}$	$V_{DS} = V_{GS}, I_D = -250\mu\text{A}$	-1.0	-1.5	-2.5	V
Static drain-source on-state resistance	$R_{DS(on)}$	$V_{GS} = -10V, I_D = -15A$		6.5	8.2	$\text{m}\Omega$
		$V_{GS} = -4.5V, I_D = -10A$		8.4	13.0	$\text{m}\Omega$
<b>Dynamic characteristics</b> <sup>④ ⑤</sup>						
Input capacitance	$C_{iss}$	$V_{DS} = -15V, V_{GS} = 0V, f = 1\text{MHz}$		3259		$\text{pF}$
Output capacitance	$C_{oss}$			404		
Reverse transfer capacitance	$C_{rss}$			282		
<b>Switching characteristics</b> <sup>④ ⑤</sup>						
Total gate charge	$Q_g$	$V_{DS} = -10V, I_D = -10A, V_{GS} = -4.5V$		30		$\text{nC}$
Gate-source charge	$Q_{gs}$			8.7		
Gate-drain charge	$Q_{gd}$			8.3		
<b>Drain-Source Diode Characteristics</b>						
Drain-source diode forward voltage	$V_{SD}$ <sup>④</sup>	$V_{GS} = 0V, I_S = -10A$			-1.2	V
Continuous drain-source diode forward current	$I_S$ <sup>①</sup>				-55	A
Pulsed drain-source diode forward current	$I_{SM}$ <sup>②</sup>				-200	A

Notes:

1.  $T_C = 25^\circ\text{C}$  Limited only by maximum temperature allowed.

2.  $P_W \leq 10\mu\text{s}$ , Duty cycle  $\leq 1\%$ .

3. EAS condition:  $V_{DD} = -15V, V_{GS} = -10V, L = 0.5\text{mH}, R_g = 25\Omega$  Starting  $T_J = 25^\circ\text{C}$ .

4. Pulse Test : Pulse Width  $\leq 300\mu\text{s}$ , duty cycle  $\leq 2\%$ .

5. Guaranteed by design, not subject to production.

6. The value of  $R_{\theta JA}$  is measured with the device mounted on 1 in<sup>2</sup> FR-4 board with 2oz. Copper, in a still air environment with  $T_a = 25^\circ\text{C}$ .

# Typical Characteristics

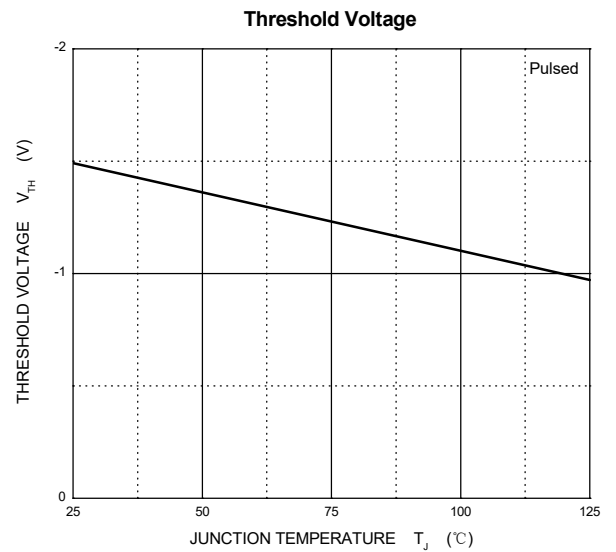
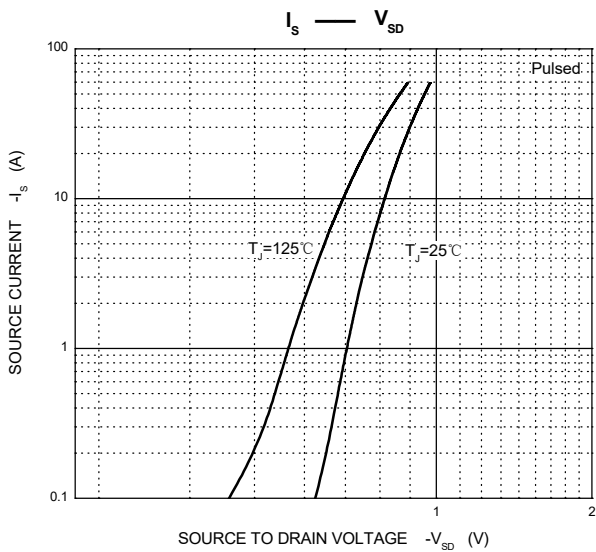
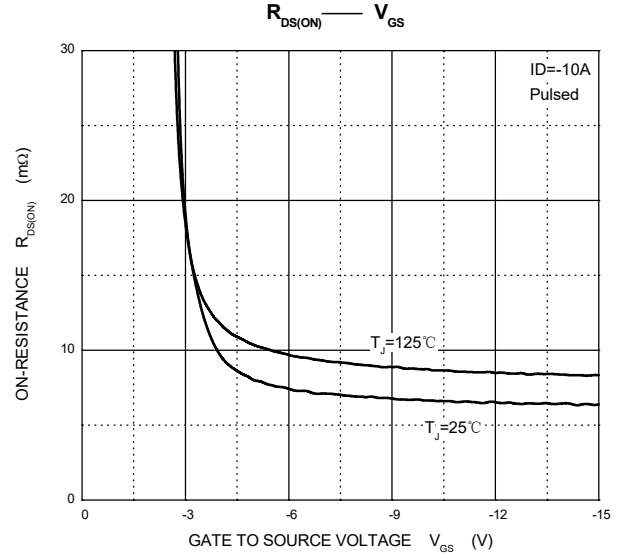
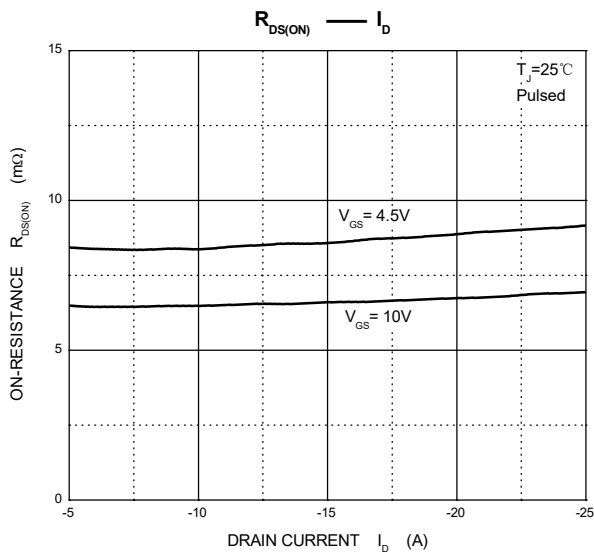
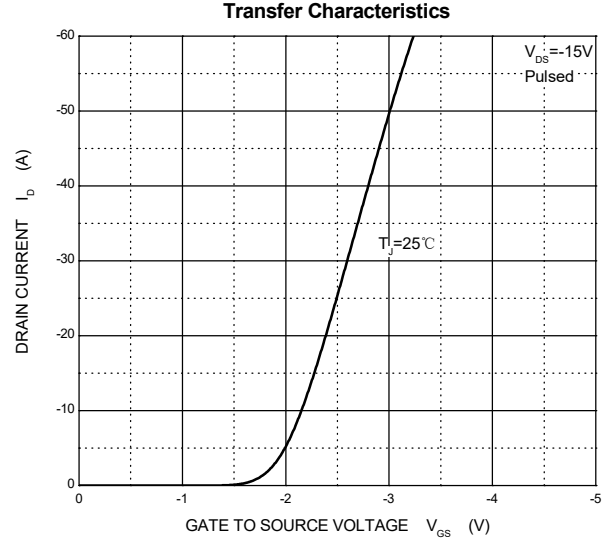
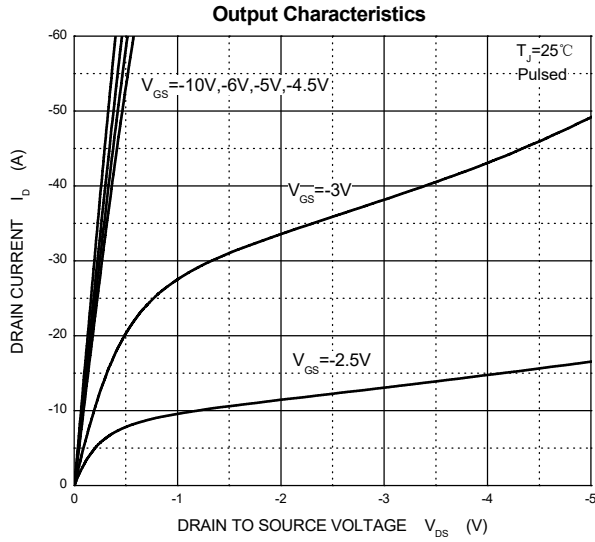

# Typical Characteristics

Capacitances

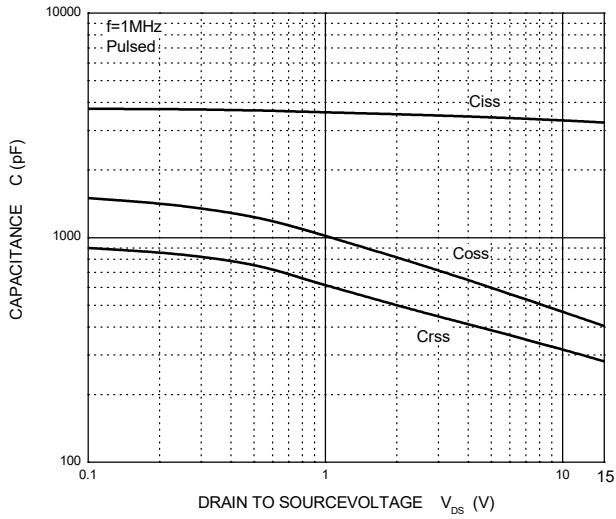

Maximum Forward Biased Safe Operating Area

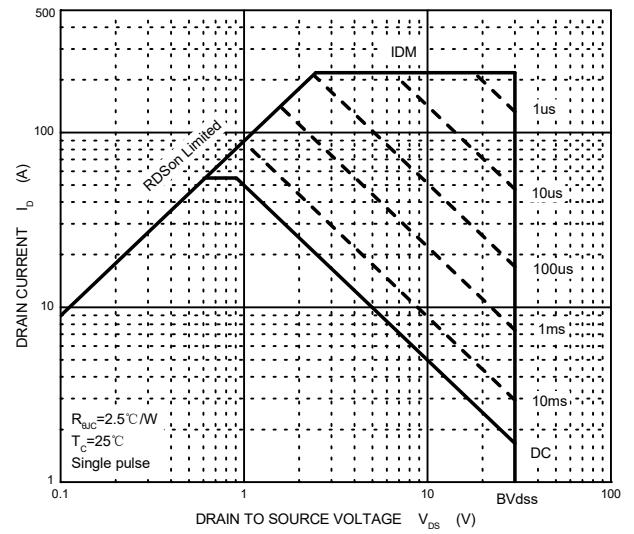

Normalized Transient Thermal Impedance

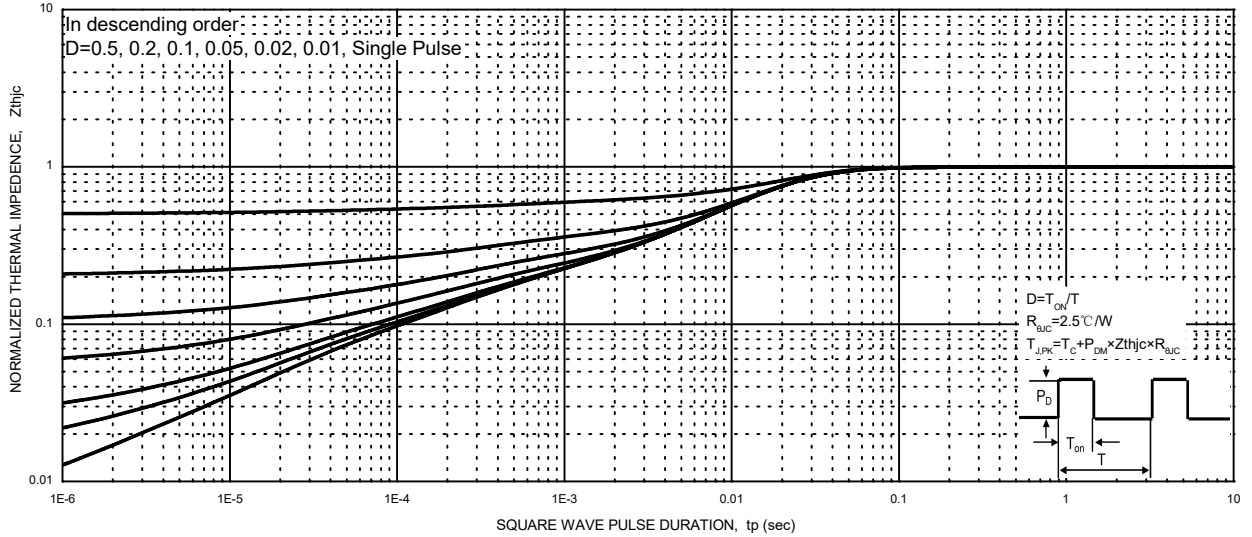

## PDFNWB3.3x3.3-8L-D Package Outline Dimensions

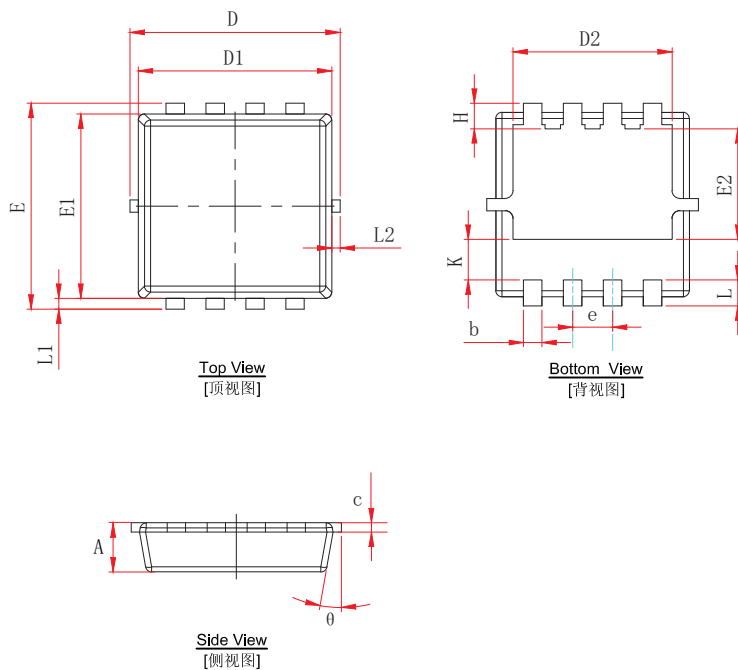

Symbol	Dimensions In Millimeters		Dimensions In Inches	
	Min.	Max.	Min.	Max.
A	0.700	0.900	0.028	0.035
b	0.200	0.400	0.008	0.016
c	0.140	0.250	0.006	0.010
D	3.200	3.400	0.126	0.134
D1	3.000	3.300	0.118	0.130
D2	2.490	2.690	0.098	0.106
e	0.650 BSC		0.026 BSC	
E	3.250	3.450	0.128	0.136
E1	2.850	3.150	0.112	0.124
E2	1.700	1.900	0.067	0.075
H	0.265	0.565	0.010	0.022
K	0.546	0.746	0.021	0.029
L	0.300	0.500	0.012	0.020
L1	0.050	0.250	0.002	0.010
L2	—	0.150	—	0.006
$\theta$	8°	12°	8°	12°

## PDFNWB3.3x3.3-8L Suggested Pad Layout

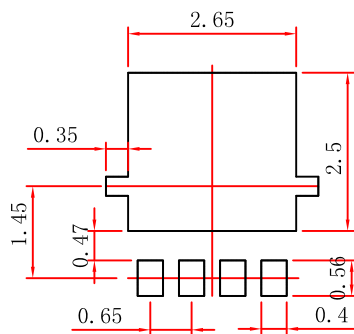

Note:

1. Controlling dimension: in millimeters.
2. General tolerance:  $\pm 0.05\text{mm}$ .
3. The pad layout is for reference purposes only.

### NOTICE

JSCJ reserves the right to make modifications, enhancements, improvements, corrections or other changes without further notice to any product herein. JSCJ does not assume any liability arising out of the application or use of any product described herein.

# PDFNWB3.3×3.3-8L Tape and Reel

## PDFNWB3.3×3.3-8L Embossed Carrier Tape

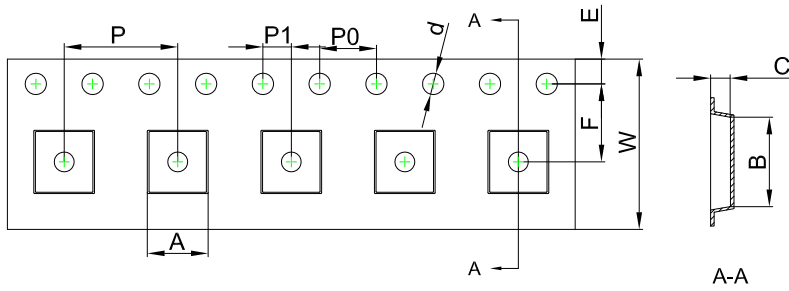

### Packaging Description:

**PDFNWB3.3×3.3-8L** parts are shipped in tape. The carrier tape is made from a dissipative (carbon filled) polycarbonate resin. The cover tape is a multilayer film (Heat Activated Adhesive in nature) primarily composed of polyester film, adhesive layer, sealant, and anti-static sprayed agent. These reeled parts in standard option are shipped with 5,000 units per 13" or 33.0 cm diameter reel. The reels are clear in color and is made of polystyrene plastic (anti-static coated).

Dimensions are in millimeter										
Pkg type	A	B	C	d	E	F	P0	P	P1	W
PDFNWB3.3×3.3-8L	3.55	3.55	1.10	Ø1.50	1.75	5.50	4.00	8.00	2.00	12.00

## PDFNWB3.3×3.3-8L Tape Leader and Trailer

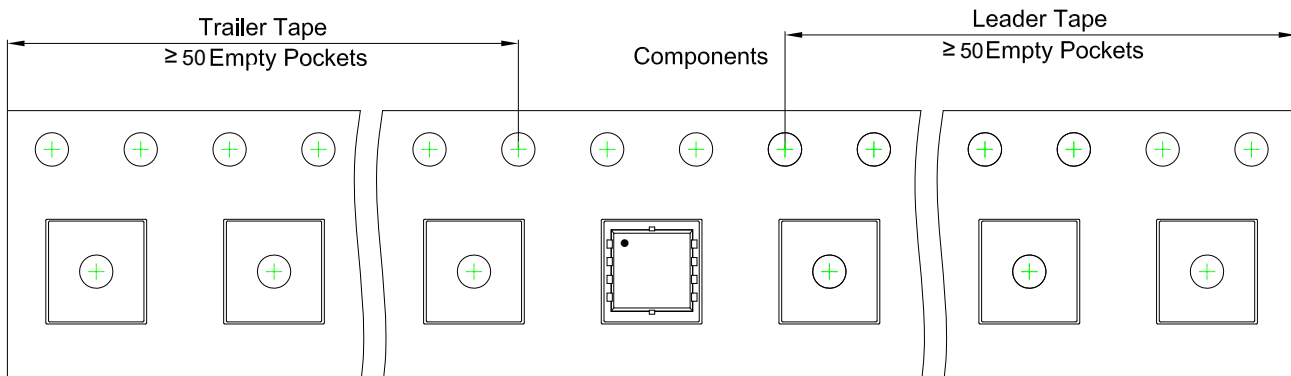

## PDFNWB3.3×3.3-8L Reel

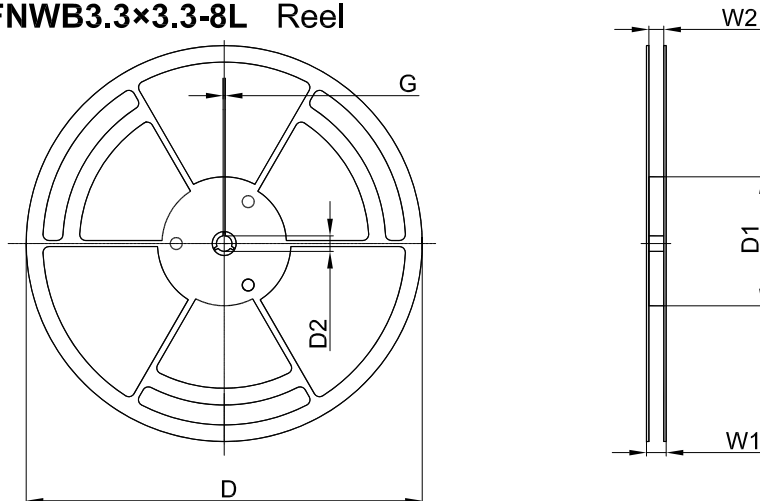

Dimensions are in millimeter						
Reel Option	D	D1	D2	G	W1	W2
13" Dia	Ø330.00	100.00	13.00	1.90	17.60	12.40

REEL	Reel Size	Box	Box Size(mm)	Carton	Carton Size(mm)
5,000 pcs	13 inch	5,000 pcs	340×336×29	50,000 pcs	353×346×365