

TO-220F Plastic-Encapsulate Transistors

KTD2058 TRANSISTOR (NPN)

FEATURES

- Low Collector Saturation Voltage

$$V_{CE(SAT)} = 1.0V(MAX)$$

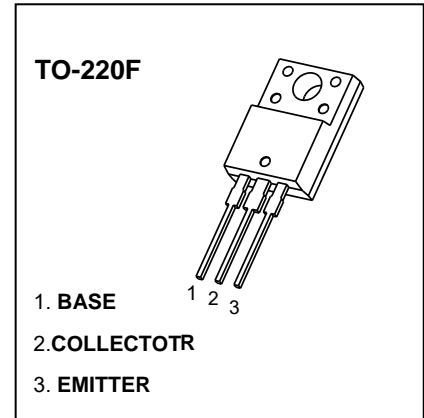

MARKING

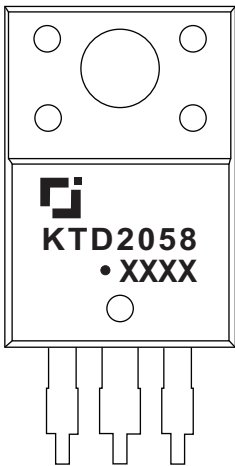

KTD2058=Device code
Solid dot=Green moldinn compound device,
if none,the normal device
XXXX=Code

Equivalent Circuit

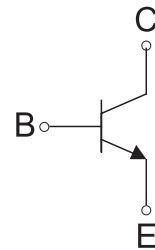

MAXIMUM RATINGS*(T_A=25°C unless otherwise noted)

Symbol	Parameter	Value	Unit
V _{CB0}	Collector-Base Voltage	60	V
V _{CEO}	Collector-Emitter Voltage	60	V
V _{EBO}	Emitter-Base Voltage	7	V
I _C	Collector Current -Continuous	3	A
P _C	Collector Power Dissipation	2	W
T _J , T _{stg}	Operation Junction and Storage Temperature Range	-55~+150	°C

*These ratings are limiting values above which the serviceability of any semiconductor device may be impaired.

ELECTRICAL CHARACTERISTICS (Ta=25°C unless otherwise specified)

Parameter	Symbol	Test conditions	Min	Typ	Max	Unit
Collector-base breakdown voltage	$V_{(BR)CBO}$	$I_C=100\mu A, I_E=0$	60			V
Collector-emitter breakdown voltage	$V_{(BR)CEO}$	$I_C=50mA, I_B=0$	60			V
Emitter-base breakdown voltage	$V_{(BR)EBO}$	$I_E=100\mu A, I_C=0$	7			V
Collector cut-off current	I_{CBO}	$V_{CB}=60V, I_E=0$			100	μA
Emitter cut-off current	I_{EBO}	$V_{EB}=7V, I_C=0$			100	μA
DC current gain	$h_{FE(1)}$	$V_{CE}=5V, I_C=0.5A$	60		200	
Collector-emitter saturation voltage	$V_{CE(sat)}$	$I_C=2A, I_B=0.2A$			1	V
Base-emitter voltage	$V_{BE(on)}$	$V_{CE}=5V, I_C=0.5A$			1	V
Transition frequency	f_T	$V_{CE}=5V, I_C=0.5A$		3		MHz
Collector output capacitance	C_{ob}	$V_{CB}=10V, I_E=0, f=1MHz$		35		pF
Switching time	Turn-on Time	t_{on}		0.65		us
	Storage Time	t_{stg}		1.3		
	Fall Time	t_f		0.65		

CLASSIFICATION of $h_{FE(1)}$

Rank	O	Y
Range	60-120	100-200

Typical Characteristics

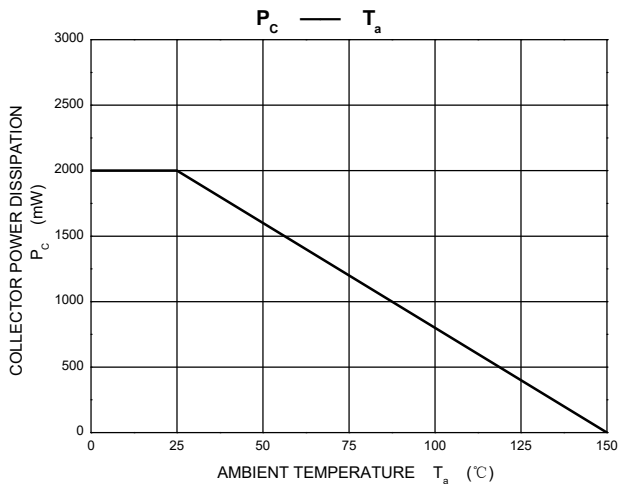
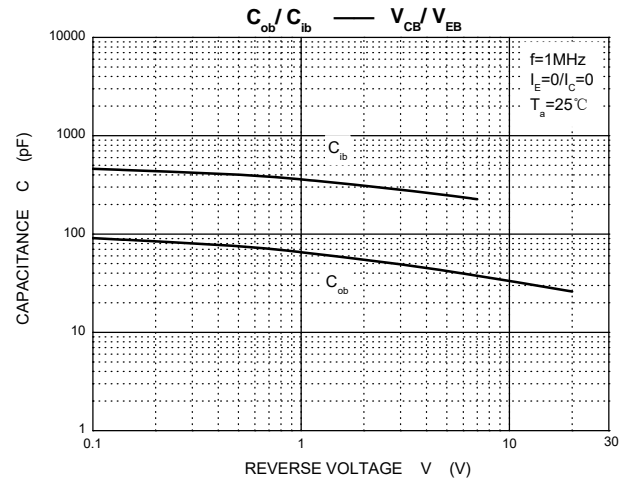
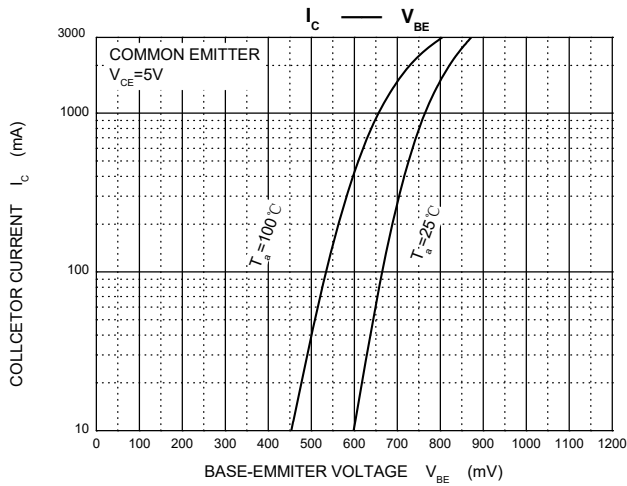
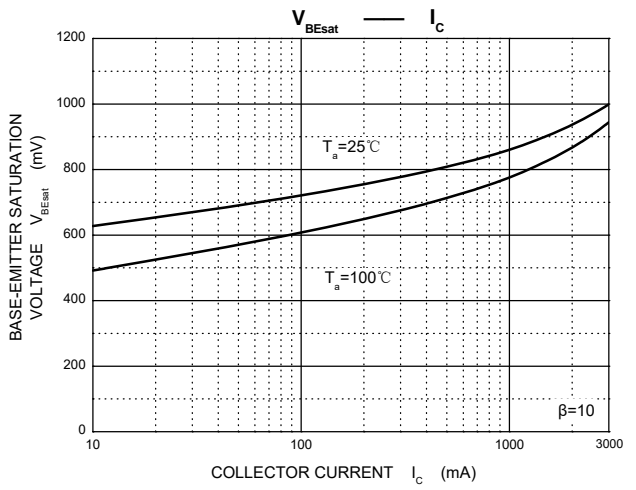
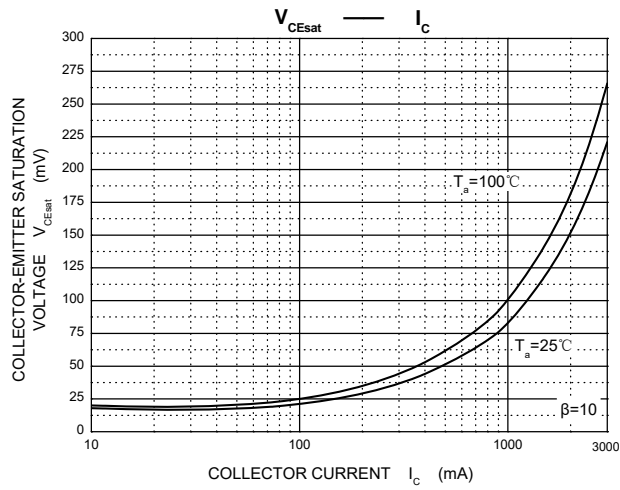
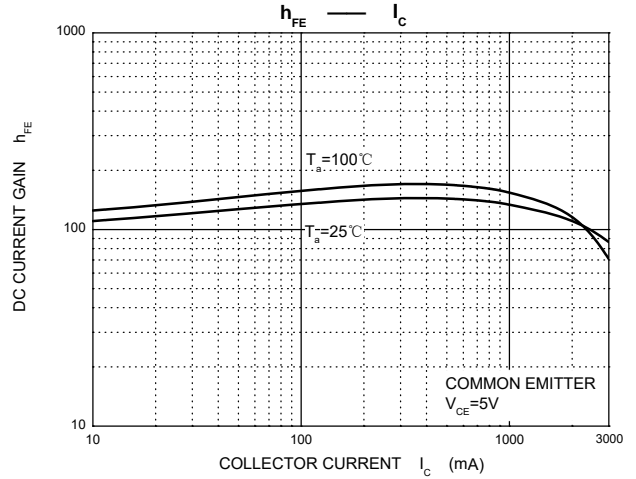
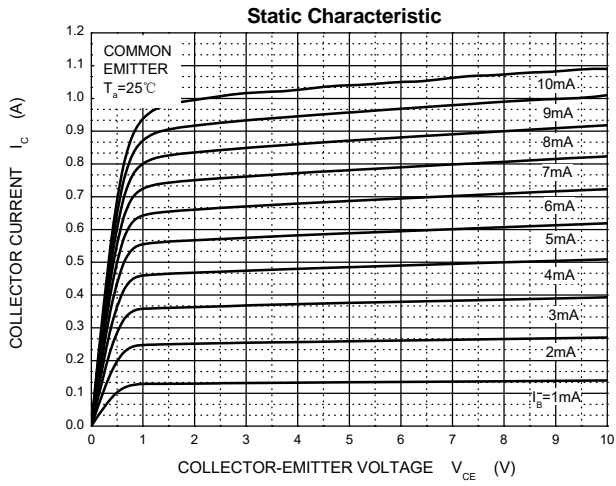

TO-220F Package Outline Dimensions

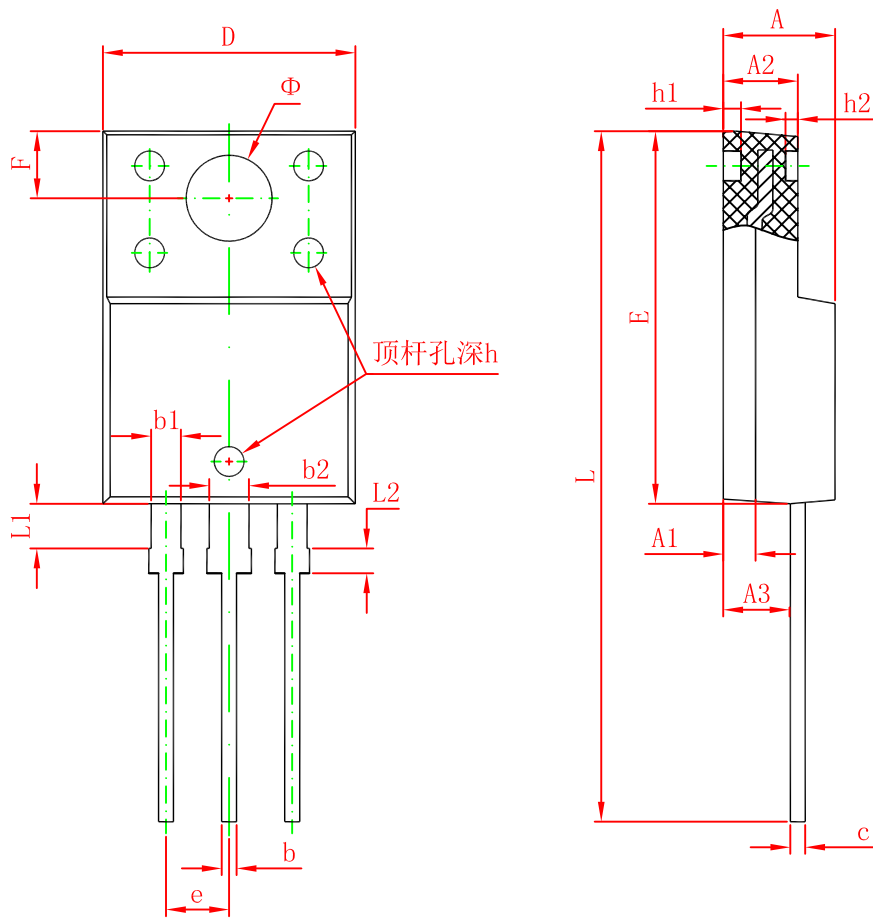

Symbol	Dimensions In Millimeters		Dimensions In Inches	
	Min.	Max.	Min.	Max.
A	4.300	4.700	0.169	0.185
A1	1.300 REF.		0.051 REF.	
A2	2.800	3.200	0.110	0.126
A3	2.500	2.900	0.098	0.114
b	0.500	0.750	0.020	0.030
b1	1.100	1.350	0.043	0.053
b2	1.500	1.750	0.059	0.069
c	0.500	0.750	0.020	0.030
D	9.960	10.360	0.392	0.408
E	14.800	15.200	0.583	0.598
e	2.540 TYP.		0.100 TYP.	
F	2.700 REF.		0.106 REF.	
Φ	3.500 REF.		0.138 REF.	
h	0.000	0.300	0.000	0.012
h1	0.800 REF.		0.031 REF.	
h2	0.500 REF.		0.020 REF.	
L	28.000	28.400	1.102	1.118
L1	1.700	1.900	0.067	0.075
L2	0.900	1.100	0.035	0.043