



CJ6330 Series Low-dropout Regulators

1 Introduction

The CJ6330 series is a group of low dropout linear regulators made by CMOS process. It supports the input voltage range of 2.5V to 18V, and can also provide current up to 300mA under the condition of good heat dissipation. The CJ6330 series has ultra-low quiescent current and low dropout voltage, which can provide large output current even when the input and output voltage difference is very small. These features can help modern appliances meet increasingly stringent energy requirements and help extend the battery life of portable power solutions.

The CJ6330 series provides a fixed voltage version with multiple output voltage points for selection. The fixed voltage version does not need external resistors and can minimize the size of printed circuit board (PCB). The CJ6330 series also has a built-in current limit and thermal shutdown, which helps to protect the regulator in the event of a load short circuit or fault.

2 Available Packages

PART NUMBER	PACKAGE
CJ6330 Series	SOT-23-3L
	SOT-89-3L
	SOT-223
	SOT-23-5L

Note: For all available packages, please refer to the part *Orderable Information*.

3 Features

- Input Voltage Range: 2.5V ~ 18V
- Fixed Output Voltage Available from 1.2V to 5.0V
- Output Voltage Tolerance:
 - ±2% for Conventional Device
 - ±1% can be Customized
- Output Current: up to 300mA
- Low Quiescent Current: 2.0µA
- Dropout Voltage:
 - 160mV@100mA ($V_{OUT} = 3.3V$)
- Power Supply Rejection Ratio:
 - 65dB@1kHz
- Low Output Noise:
 - $27 \times V_{OUT} \mu V_{RMS}$ (10Hz ~ 100kHz)
- Excellent Transient Response
- Integrated Fault Protection:
 - Fold-back Current Limit
 - Thermal Shutdown
 - Short-Circuit Protection

4 Applications

- Always-on Power Supplies
- Gaming Controllers, Remote Controls, Toys, Drones
- Portable and Battery-powered Equipment
- Set-top Boxes
- Ultrabooks, Tablets, E-readers
- Wearable Electronics
- Wireless Handsets and Smart Phones

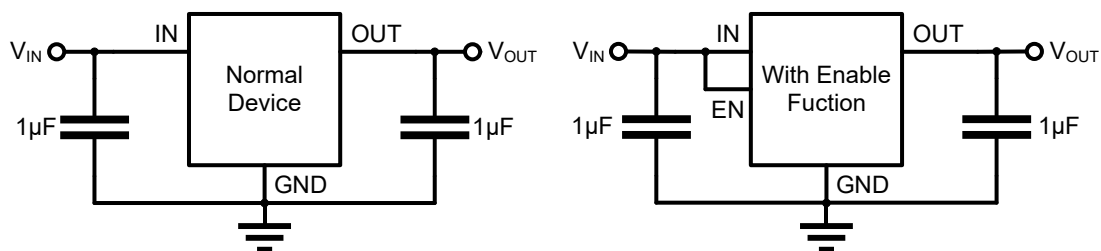

Typical Application Circuits

5 Orderable Information

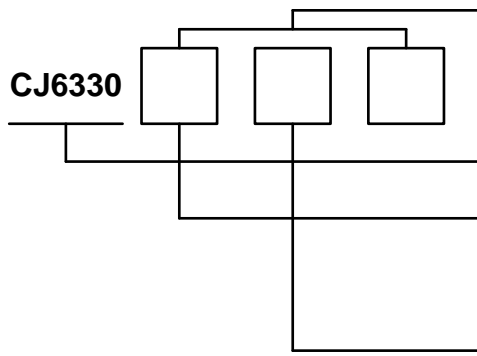

Package type.

A□M / A□MC / A□MY: SOT-23-3L
 A□P / A□PT / A□PL: SOT-89-3L
 A□G / A□GF: SOT-223
 B□M / A□MF / A□MR: SOT-23-5L

Device serial number.

Enable function marking.

A: Normal device, no enable function
 B: With enable function

Output voltage.

12: Fixed output 1.2V
 15: Fixed output 1.5V
 18: Fixed output 1.8V
 25: Fixed output 2.5V
 28: Fixed output 2.8V
 30: Fixed output 3.0V
 33: Fixed output 3.3V
 36: Fixed output 3.6V
 50: Fixed output 5.0V

Figure 5-1. Naming Conventions

MODEL	DEVICE	PACKAGE	OP TEMP	ECO PLAN	MSL	PACKING OPTION	SORT
3 Pins Packaged Products							
CJ6330-1.2	CJ6330A12M	SOT-23-3L	-40 ~ 85°C	RoHS & Green	Level 3 168 HR	Tape and Reel 3000 Units / Reel	Active
CJ6330-1.5	CJ6330A15M	SOT-23-3L	-40 ~ 85°C	RoHS & Green	Level 3 168 HR	Tape and Reel 3000 Units / Reel	Active
CJ6330-1.8	CJ6330A18M	SOT-23-3L	-40 ~ 85°C	RoHS & Green	Level 3 168 HR	Tape and Reel 3000 Units / Reel	Active
CJ6330-2.5	CJ6330A25M	SOT-23-3L	-40 ~ 85°C	RoHS & Green	Level 3 168 HR	Tape and Reel 3000 Units / Reel	Active
CJ6330-2.8	CJ6330A28M	SOT-23-3L	-40 ~ 85°C	RoHS & Green	Level 3 168 HR	Tape and Reel 3000 Units / Reel	Active
CJ6330-3.0	CJ6330A30M	SOT-23-3L	-40 ~ 85°C	RoHS & Green	Level 3 168 HR	Tape and Reel 3000 Units / Reel	Active
CJ6330-3.3	CJ6330A33M	SOT-23-3L	-40 ~ 85°C	RoHS & Green	Level 3 168 HR	Tape and Reel 3000 Units / Reel	Active
CJ6330-3.6	CJ6330A36M	SOT-23-3L	-40 ~ 85°C	RoHS & Green	Level 3 168 HR	Tape and Reel 3000 Units / Reel	Active
CJ6330-5.0	CJ6330A50M	SOT-23-3L	-40 ~ 85°C	RoHS & Green	Level 3 168 HR	Tape and Reel 3000 Units / Reel	Active
CJ6330-5.0	CJ6330A50G	SOT-223	-40 ~ 85°C	RoHS & Green	Level 3 168 HR	Tape and Reel 2500 Units / Reel	Active

5 Orderable Information

MODEL	DEVICE	PACKAGE	OP TEMP	ECO PLAN	MSL	PACKING OPTION	SORT
3 Pins Packaged Products (continued)							
CJ6330-1.8	CJ6330A18P	SOT-89-3L	-40 ~ 85°C	RoHS & Green	Level 3 168 HR	Tape and Reel 1000 Units / Reel	Active
CJ6330-2.5	CJ6330A25P	SOT-89-3L	-40 ~ 85°C	RoHS & Green	Level 3 168 HR	Tape and Reel 1000 Units / Reel	Active
CJ6330-2.8	CJ6330A28P	SOT-89-3L	-40 ~ 85°C	RoHS & Green	Level 3 168 HR	Tape and Reel 1000 Units / Reel	Active
CJ6330-3.0	CJ6330A30P	SOT-89-3L	-40 ~ 85°C	RoHS & Green	Level 3 168 HR	Tape and Reel 1000 Units / Reel	Active
CJ6330-3.3	CJ6330A33P	SOT-89-3L	-40 ~ 85°C	RoHS & Green	Level 3 168 HR	Tape and Reel 1000 Units / Reel	Active
CJ6330-3.6	CJ6330A36P	SOT-89-3L	-40 ~ 85°C	RoHS & Green	Level 3 168 HR	Tape and Reel 1000 Units / Reel	Active
CJ6330-5.0	CJ6330A50P	SOT-89-3L	-40 ~ 85°C	RoHS & Green	Level 3 168 HR	Tape and Reel 1000 Units / Reel	Active
5 Pins Packaged Products							
CJ6330-1.2	CJ6330B12M	SOT-23-5L	-40 ~ 85°C	RoHS & Green	Level 3 168 HR	Tape and Reel 3000 Units / Reel	Active
CJ6330-1.5	CJ6330B15M	SOT-23-5L	-40 ~ 85°C	RoHS & Green	Level 3 168 HR	Tape and Reel 3000 Units / Reel	Active
CJ6330-1.8	CJ6330B18M	SOT-23-5L	-40 ~ 85°C	RoHS & Green	Level 3 168 HR	Tape and Reel 3000 Units / Reel	Active
CJ6330-2.5	CJ6330B25M	SOT-23-5L	-40 ~ 85°C	RoHS & Green	Level 3 168 HR	Tape and Reel 3000 Units / Reel	Active
CJ6330-2.8	CJ6330B28M	SOT-23-5L	-40 ~ 85°C	RoHS & Green	Level 3 168 HR	Tape and Reel 3000 Units / Reel	Active
CJ6330-3.0	CJ6330B30M	SOT-23-5L	-40 ~ 85°C	RoHS & Green	Level 3 168 HR	Tape and Reel 3000 Units / Reel	Active
CJ6330-3.3	CJ6330B33M	SOT-23-5L	-40 ~ 85°C	RoHS & Green	Level 3 168 HR	Tape and Reel 3000 Units / Reel	Active
CJ6330-3.6	CJ6330B36M	SOT-23-5L	-40 ~ 85°C	RoHS & Green	Level 3 168 HR	Tape and Reel 3000 Units / Reel	Active
CJ6330-5.0	CJ6330B50M	SOT-23-5L	-40 ~ 85°C	RoHS & Green	Level 3 168 HR	Tape and Reel 3000 Units / Reel	Active

5 Orderable Information

MODEL	DEVICE	PACKAGE	OP TEMP	ECO PLAN	MSL	PACKING OPTION	SORT
Customized Products							
CJ6330-x.x	CJ6330AxxMC	SOT-23-3L	-40 ~ 85°C	RoHS & Green	Level 3 168 HR	Tape and Reel 3000 Units / Reel	Customized
	CJ6330AxxMY	SOT-23-3L	-40 ~ 85°C	RoHS & Green	Level 3 168 HR	Tape and Reel 3000 Units / Reel	Customized
	CJ6330AxxPT	SOT-89-3L	-40 ~ 85°C	RoHS & Green	Level 3 168 HR	Tape and Reel 1000 Units / Reel	Customized
	CJ6330AxxPL	SOT-89-3L	-40 ~ 85°C	RoHS & Green	Level 3 168 HR	Tape and Reel 1000 Units / Reel	Customized
	CJ6330AxxGF	SOT-223	-40 ~ 85°C	RoHS & Green	Level 3 168 HR	Tape and Reel 2500 Units / Reel	Customized
	CJ6330AxxMF	SOT-23-5L	-40 ~ 85°C	RoHS & Green	Level 3 168 HR	Tape and Reel 3000 Units / Reel	Customized
	CJ6330AxxMR	SOT-23-5L	-40 ~ 85°C	RoHS & Green	Level 3 168 HR	Tape and Reel 3000 Units / Reel	Customized
CJ6330-x.x ±1% grade	-	-	-40 ~ 85°C	RoHS & Green	-	-	Customized
Others	-	-	-	-	-	-	Customized

Note:

ECO PLAN: For the RoHS and Green certification standards of this product, please refer to the official report provided by JSCJ.

MSL: Moisture Sensitivity Level. Determined according to JEDEC industry standard classification.

SORT: Specifically defined as follows:

Active: Recommended for new products;

Customized: Products manufactured to meet the specific needs of customers;

Preview: The device has been released and has not been fully mass produced. The sample may or may not be available;

NoRD: It is not recommended to use the device for new design. The device is only produced for the needs of existing customers;

Obsolete: The device has been discontinued.

6 Pin Configuration and Marking Information

6.1 Pin Configuration

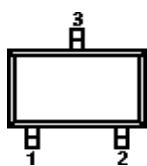

SOT-23-3L

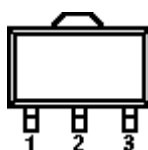

SOT-89-3L

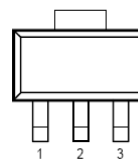

SOT-223

PIN NAME	3 Pins SOT Series Packages							
	SOT-23-3L			SOT-89-3L			SOT-223	
	AxxM	AxxMC	AxxMY	AxxP	AxxPT	AxxPL	AxxG	AxxGF
IN	3	1	2	2	3	1	1	3
GND	1	3	3	1	2	2	2	2
OUT	2	2	1	3	1	3	3	1

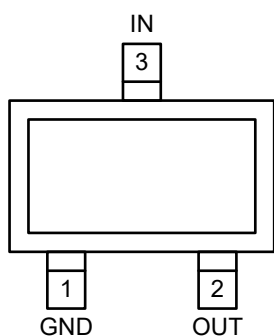

CJ6330AxxM
SOT-23-3L

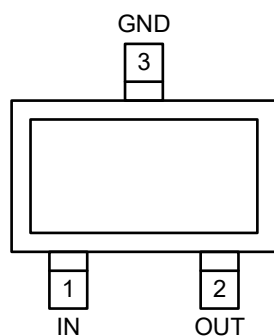

CJ6330AxxMC
SOT-23-3L

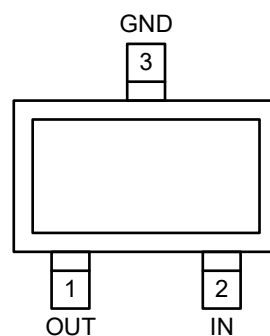

CJ6330AxxMY
SOT-23-3L

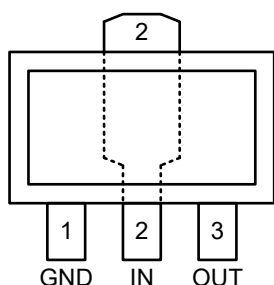

CJ6330AxxP
SOT-89-3L

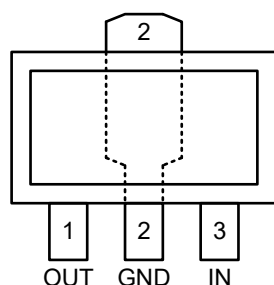

CJ6330AxxPT
SOT-89-3L

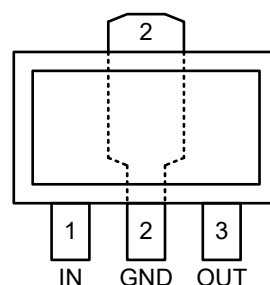

CJ6330AxxPL
SOT-89-3L

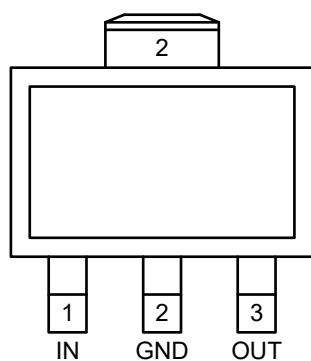

CJ6330AxxG
SOT-223

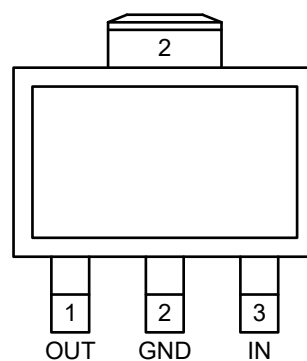

CJ6330AxxGF
SOT-223

6 Pin Configuration and Marking Information

6.1 Pin Configuration (continued)

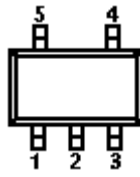

SOT-23-5L

PIN NAME	5 Pins SOT Series Packages		
	SOT-23-5L		
	BxxM	AxxMF	AxxMR
IN	1	1	2
GND	2	2	1
EN	3	-	-
NC	4	3 & 4	4 & 5
OUT	5	5	3

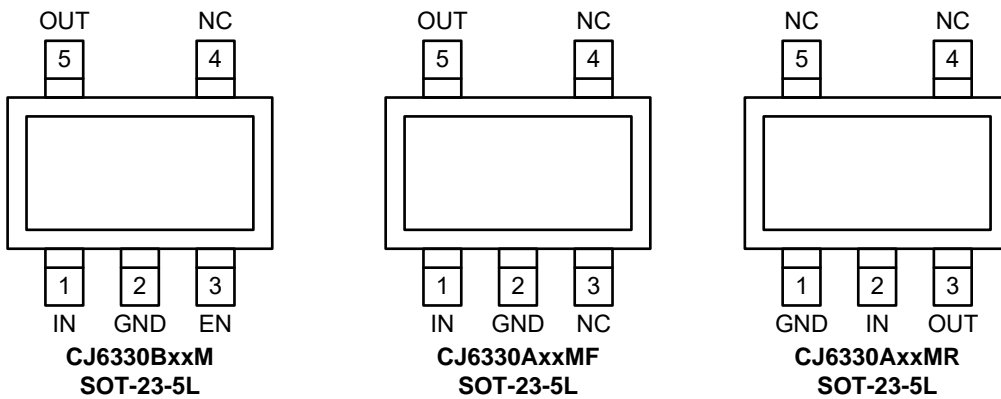

6.2 Pin Function

PIN NAME	I / O	CJ6330 Series Pin Function
		DESCRIPTION
IN	I	Input to the device. Use the recommended value of the input capacitor and place it as close to the IN and GND pins of the device as possible to help obtain the best transient response and minimize the input impedance.
GND	-	Regulator ground.
EN	I	Enable pin. Drive EN high level to enable the device, and drive EN low level to turn off the device. Do not float this pin. If not need, connect EN to IN.
NC	-	No internal connection. This pin can float, but when this pin is connected to GND, the device has better thermal performance.
OUT	O	Output of the regulator. An output capacitor needs to be placed between OUT and GND to maintain the stability of the device output. Use the capacitor with the recommended value and place it as close as possible to the OUT and GND pins of the device to help obtain the best transient response.

6 Pin Configuration and Marking Information

6.3 Marking Information

Output Voltage	3 Pins SOT Series Packages					
	SOT-23-3L		SOT-89-3L		SOT-223	
	Conventional	Customized	Conventional	Customized	Conventional	Customized
1.2V	CJ6330A12M: DBXX	-	-	-	-	-
1.5V	CJ6330A15M: DCXX	-	-	-	-	-
1.8V	CJ6330A18M: A7jXX	-	CJ6330A18P: DDXX	-	-	-
2.5V	CJ6330A25M: A7qXX	-	CJ6330A25P: DEXX	-	-	-
2.8V	CJ6330A28M: A7tXX	-	CJ6330A28P: A7tXX	-	-	-
3.0V	CJ6330A30M: A7vXX	-	CJ6330A30P: DGXX	CJ6330A30PT: DGXXT	-	-
3.3V	CJ6330A33M: A7yXX	-	CJ6330A33P: A7yXX	CJ6330A33PT: DHXXT	-	CJ6330A33GF: DHXXF
3.6V	CJ6330A36M: A7bXX	-	CJ6330A36P: DIXX	-	-	-
5.0V	CJ6330A50M: A7PXX	-	CJ6330A50P: DKXX	CJ6330A50PT: DKXXT	CJ6330A50G: DKXX	CJ6330A50GF: DKXXF

Output Voltage	5 Pins SOT Series Packages	
	SOT-23-5L	
	Conventional	Customized
1.2V	CJ6330B12M: DBXX	-
1.5V	CJ6330B15M: DCXX	-
1.8V	CJ6330B18M: A9jXX	CJ6330A18MR: DDXXR
2.5V	CJ6330B25M: A9qXX	-
2.8V	CJ6330B28M: A9tXX	-
3.0V	CJ6330B30M: A9vXX	-
3.3V	CJ6330B33M: A9yXX	CJ6330A33MR: DHXXR
3.6V	CJ6330B36M: A9bXX	-
5.0V	CJ6330B50M: A9PXX	CJ6330A50MR: DKXXR

Note:

The "XX" in the marking is composed of two capital letters, which is the production date code. For example, the marking of CJ6330A33PT is "DHXXT", where "XX" is the date code of production. The date code "XX" may be different for products produced in different periods.

7 Specifications

7.1 Absolute Maximum Ratings

($T_A = 25^\circ\text{C}$, unless otherwise specified)⁽¹⁾

CHARACTERISTIC		SYMBOL	VALUE	UNIT	
Input voltage range ⁽²⁾		V_{IN}	-0.3 ~ 24	V	
Enable input voltage range ⁽²⁾		V_{EN}	-0.3 ~ 24		
Output voltage range ⁽²⁾		V_{OUT}	-0.3 ~ 10		
Maximum power dissipation	CJ6330 Series	SOT-23-3L	$P_{D\ Max}$	Internally Limited ⁽³⁾	W
		SOT-89-3L			
		SOT-223			
		SOT-23-5L			
Maximum junction temperature		$T_{J\ Max}$	125	$^\circ\text{C}$	
Storage temperature		T_{stg}	-40 ~ 125	$^\circ\text{C}$	
Soldering temperature & time		T_{solder}	260 $^\circ\text{C}$, 10s	-	

(1) Stresses beyond those listed under *Absolute Maximum Ratings* may cause permanent damage to the device. These are stress ratings only, which do not imply functional operation of the device at these or any other conditions beyond those indicated under *Recommended Operating Conditions*. Exposure to absolute-maximum rated conditions for extended periods may affect device reliability.

(2) All voltages are with respect to network ground terminal.

(3) Refer to *Thermal Information* for details.

7.2 Recommended Operating Conditions

PARAMETER	SYMBOL	MIN.	NOM.	MAX.	UNIT
Input voltage	V_{IN}	2.5	-	18	V
Operating junction temperature	T_J	-40	-	125	$^\circ\text{C}$
Operating ambient temperature ⁽⁴⁾	T_A	-40	-	85	$^\circ\text{C}$

(4) It is necessary to ensure that the operating junction temperature of the device does not exceed the rated value of the recommended operating conditions when using the device for design.

7.3 ESD Ratings

ESD RATINGS		SYMBOL	VALUE	UNIT
Electrostatic discharge ⁽⁵⁾	Human body model	$V_{ESD-HBM}$	2000	V
	Machine model	V_{ESD-MM}	200	

(5) ESD testing is conducted in accordance with the relevant specifications formulated by the Joint Electronic Equipment Engineering Commission (JEDEC). The human body model (HBM) electrostatic discharge test is based on the JESD22-114D test standard, using a 100pF capacitor and discharging to each pin of the device through a resistance of 1.5k Ω . The electrostatic discharge test in mechanical model (MM) is based on the JESD22-115-A test standard and uses a 200pF capacitor to discharge directly to each pin of the device.

7 Specifications

7.4 Thermal Information

THERMAL METRIC ⁽⁶⁾	SYMBOL	CJ6330 Series		UNIT
		SOT-23-3L	SOT-89-3L	
Junction-to-ambient thermal resistance	R _{θJA}			°C/W
		261.2	159.4	
		SOT-223	SOT-23-5L	
		102.6	247.3	
Junction-to-case thermal resistance	R _{θJC}			°C/W
		65.7	54.7	
		SOT-223	SOT-23-5L	
		18.6	64.9	
Reference maximum power dissipation for continuous operation	P _{D Ref}			W
		0.38	0.60	
		SOT-223	SOT-23-5L	
		1.00	0.40	

(6) Thermal metric is measured in still air with T_A = 25°C and installed on a 1 in² FR-4 board covered with 2 ounces of copper.

7 Specifications

7.5 Electrical Characteristics

CJ6330 Series ($V_{IN} = V_{OUT} + 1V$, $C_{IN} = 1.0\mu F$, $C_{OUT} = 1.0\mu F$, $T_A = 25^\circ C$, unless otherwise specified)

CHARACTERISTIC	SYMBOL	TEST CONDITIONS		MIN.	TYP. ⁽⁷⁾	MAX.	UNIT
Input voltage	V_{IN}	$T_A = 25^\circ C$		2.5	-	18	V
DC output tolerance	-	$T_J = 25^\circ C$, $I_{OUT} = 1mA$		-2	-	2	%
				-1 ⁽⁸⁾	-	1 ⁽⁸⁾	
Output current	I_{OUT}	$T_J = 25^\circ C$		300	-	-	mA
Quiescent current	I_Q	$I_{OUT} = 0mA$		-	2.0	5.0	μA
Dropout voltage	$V_{DO}^{(9)}$	$I_{OUT} = 100mA$	$V_{OUT} < 1.8V$	-	350	700	mV
			$V_{OUT} = 1.8$ to $2.8V$	-	200	500	
			$V_{OUT} = 3.0$ to $3.6V$	-	160	270	
			$V_{OUT} = 5.0V$	-	110	270	
Line regulation	$LNR^{(10)}$	$V_{IN} = V_{OUT} + 1V$ to $18V$, $I_{OUT} = 10mA$		-	0.01	0.3	%/V
Load regulation	ΔV_{LOAD}	$V_{IN} = V_{OUT} + 1V$, $I_{OUT} = 1$ to $100mA$		-	10	-	mV
Temperature characteristics	$TR^{(11)}$	$I_{OUT} = 10mA$, $T_A = -40$ to $125^\circ C$		-	50	-	ppm/ $^\circ C$
Output current limit	I_{Limit}	$V_{OUT} = 0.5 \times V_{OUT Normal}$, $V_{IN} = 5.0V$		350	500	-	mA
Short current	I_{Short}	OUT short to GND		-	75	-	mA
Standby current	I_{STBY}	EN = GND		-	-	0.2	μA
Power supply rejection ratio	PSRR	$I_{OUT} = 50mA$, $V_{IN} = (V_{OUT} + 1.5V)_{DC} + 1V_{PP AC}$	$f = 100Hz$	-	75	-	dB
			$f = 1kHz$	-	65	-	
			$f = 10kHz$	-	50	-	
			$f = 100kHz$	-	40	-	
Output noise voltage	V_N	BW = 10 to 100kHz		-	$27 \times V_{OUT}$	-	μV_{RMS}
EN high	$V_{EN H}$	-		1.5	-	V_{IN}	V
EN low	$V_{EN L}$	-		-	-	0.3	V
C_{OUT} auto-discharge resistance	$R_{Discharge}$	$V_{IN} = 5.0V$, $V_{OUT} = 3.0V$, EN = GND		-	150	-	Ω
Thermal shutdown	T_{SD}	-		-	150	-	$^\circ C$
Thermal shutdown hysteresis	ΔT_{SD}	-		-	20	-	$^\circ C$

7 Specifications

7.5 Electrical Characteristics (continued)

Note:

(7) Typical numbers are at 25°C and represent the most likely norm.

(8) Products with ±1% output tolerance can be customized.

(9) Test the difference of output voltage and input voltage when input voltage is decreased gradually till output voltage equals to 98% of $V_{OUT\ Normal}$.

(10) The line regulation is calculated by the following formula:

$$LNR = \frac{\Delta V_{OUT}}{V_{OUT} \times \Delta V_{IN}}$$

where, ΔV_{OUT} is the variation of the output voltage, ΔV_{IN} is the variation of the input voltage.

(11) The output voltage temperature characteristics (TR) is calculated by the following formula:

$$TR = \frac{\Delta V_{OUT}}{V_{OUT} \times \Delta T}$$

where, ΔV_{OUT} is the variation of the output voltage, ΔT is the variation of the ambient temperature.

7.6 Typical Characteristics

CJ6330 Series ($V_{EN} = V_{IN}$, $C_{IN} = 1.0\mu F$, $C_{OUT} = 1.0\mu F$, $T_A = 25^\circ C$, unless otherwise specified)

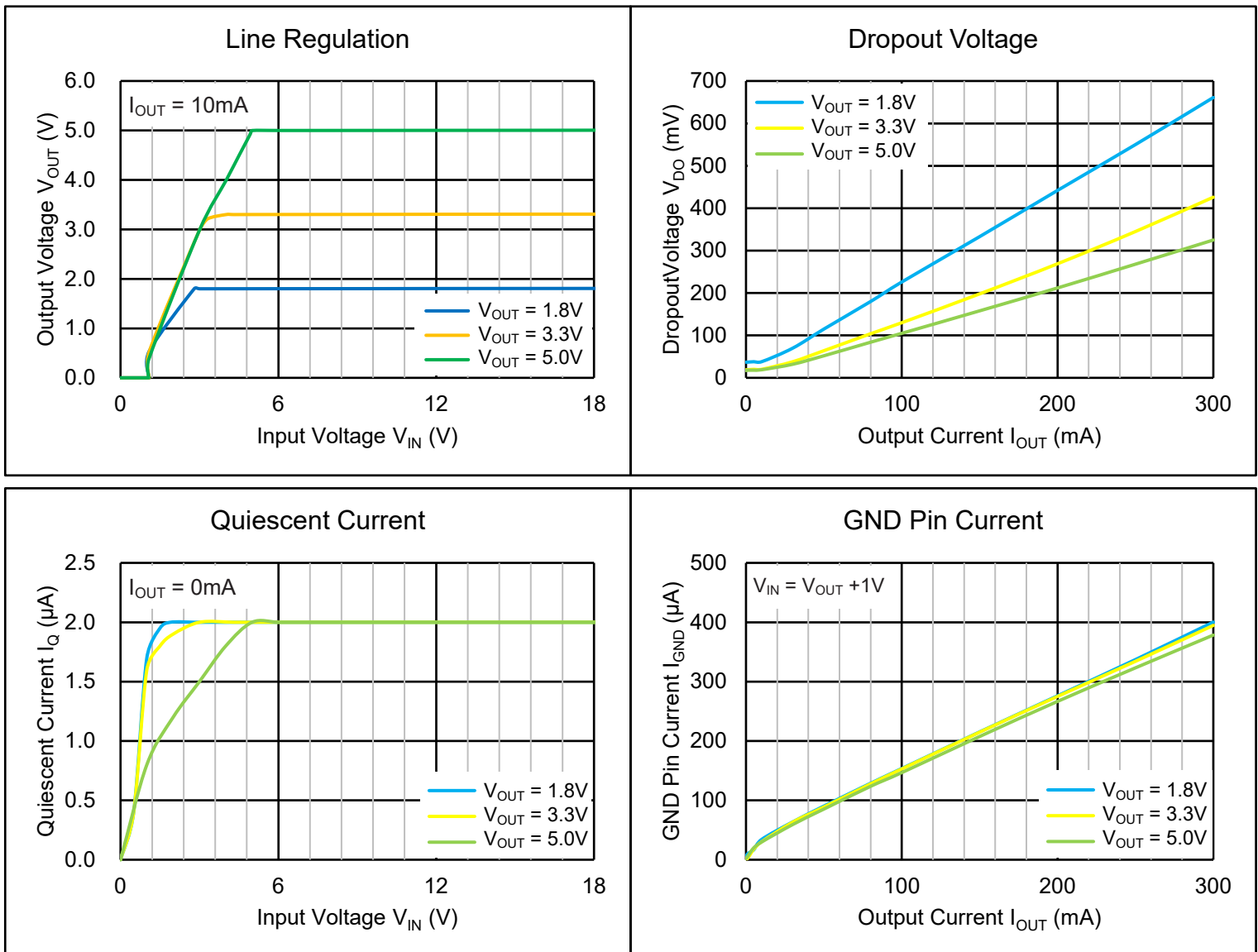

7 Specifications

7.6 Typical Characteristics (continued)

CJ6330 Series ($C_{IN} = 1.0\mu F$, $C_{OUT} = 1.0\mu F$, $T_A = 25^\circ C$, unless otherwise specified)

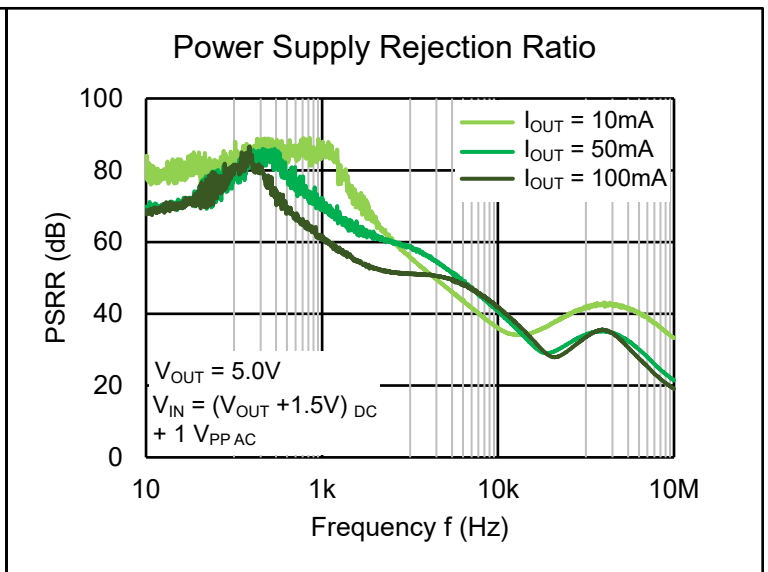
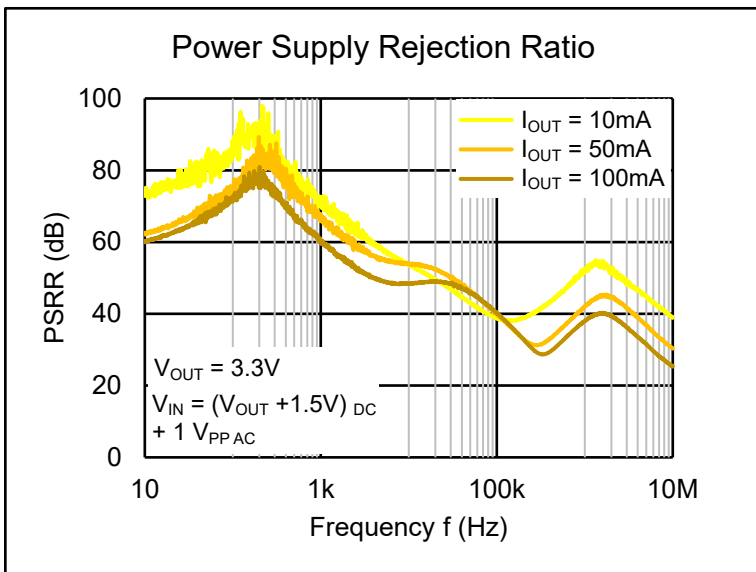
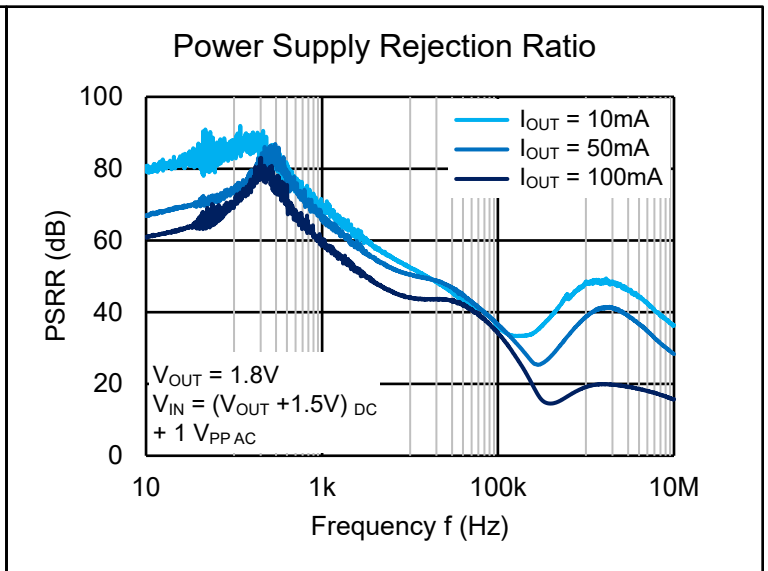
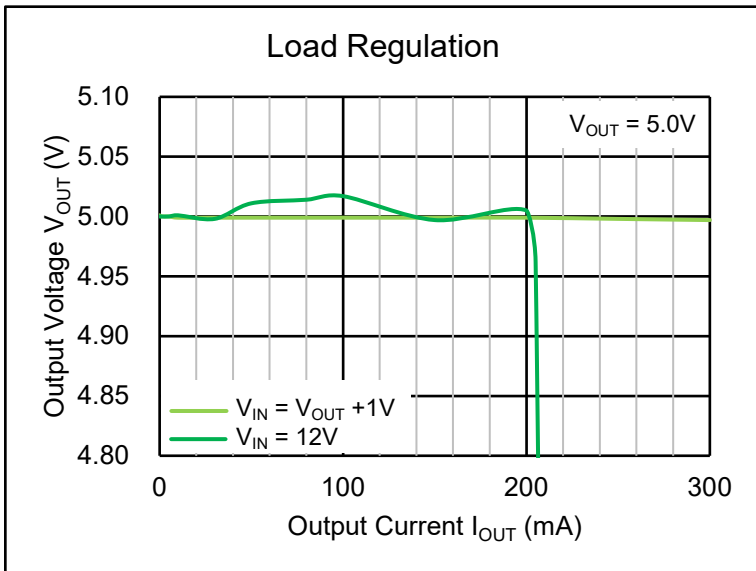
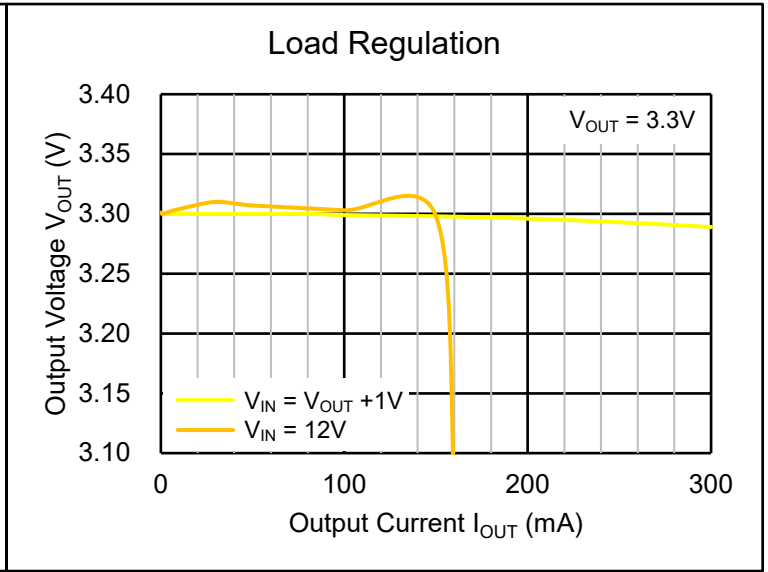
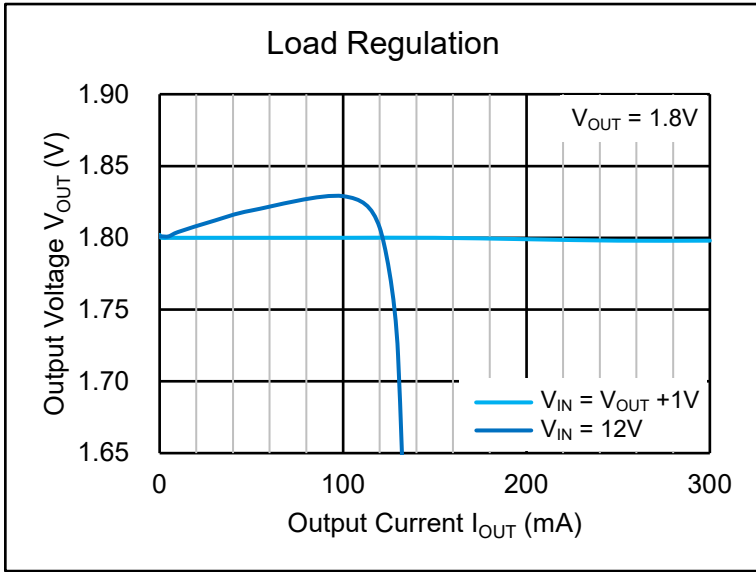

7 Specifications

7.6 Typical Characteristics (continued)

CJ6330 Series ($C_{IN} = 1.0\mu F$, $C_{OUT} = 1.0\mu F$, $T_A = 25^\circ C$, unless otherwise specified)

Load Transient

$V_{OUT} = 1.8V$, $V_{IN} = V_{EN} = V_{OUT} + 1V$, **CH2: V_{OUT}** , **CH4: I_{OUT}**

$I_{OUT}: 0 \sim 100mA$

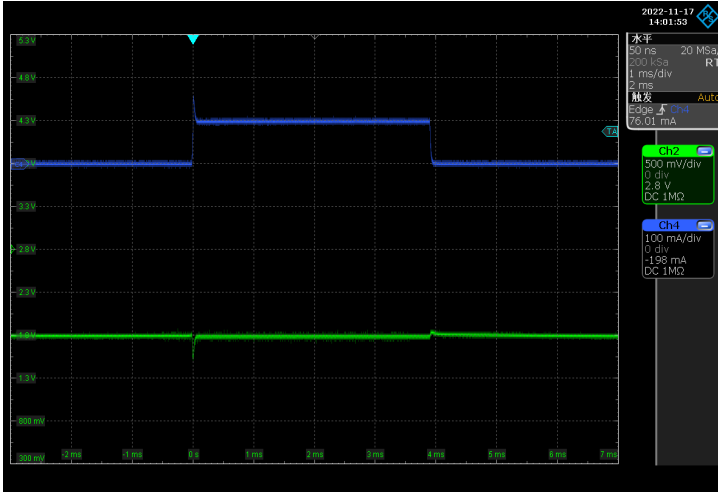

$I_{OUT}: 0 \sim 300mA$

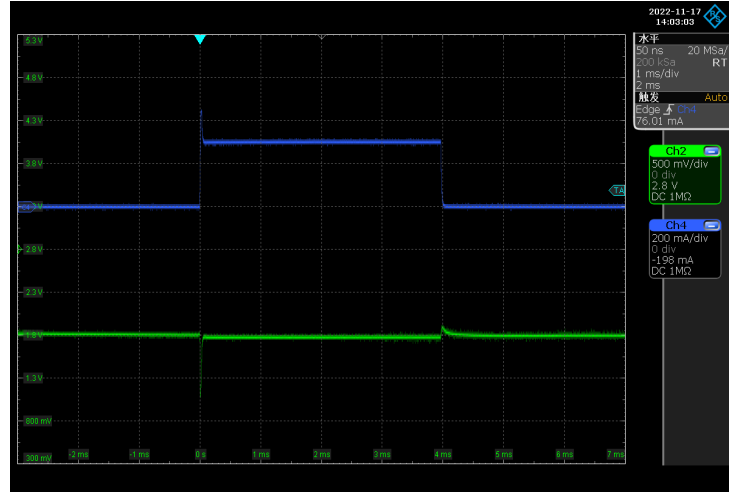

$I_{OUT}: 10 \sim 150mA$

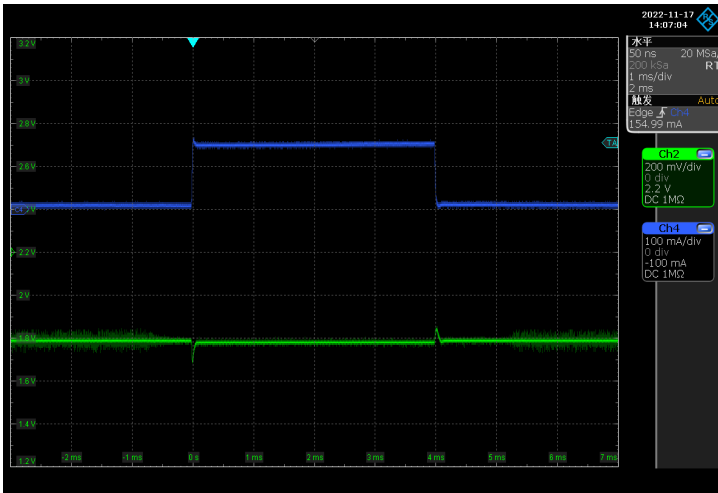

$I_{OUT}: 50 \sim 250mA$

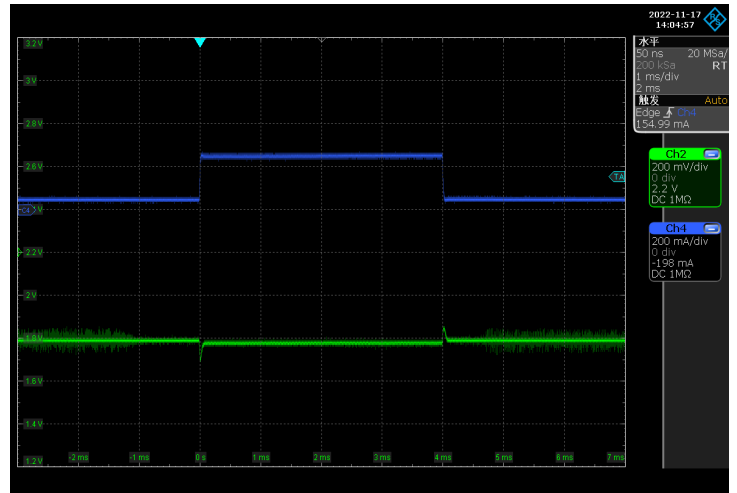

$V_{OUT} = 3.3V$, $V_{IN} = V_{EN} = V_{OUT} + 1V$, **CH2: V_{OUT}** , **CH4: I_{OUT}**

$I_{OUT}: 0 \sim 100mA$

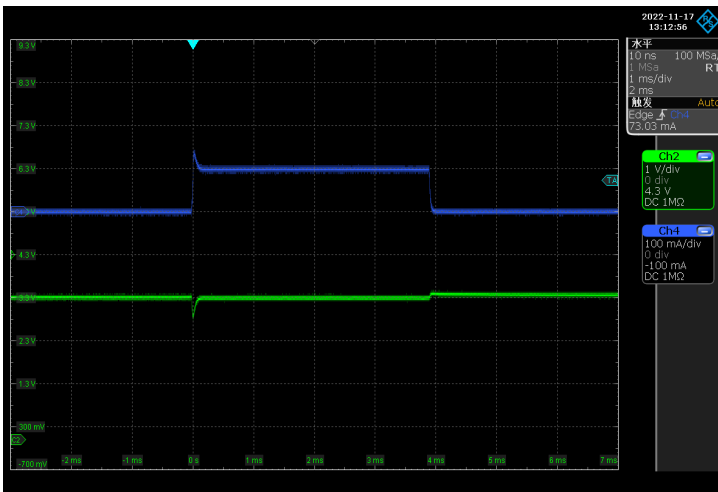

$I_{OUT}: 0 \sim 300mA$

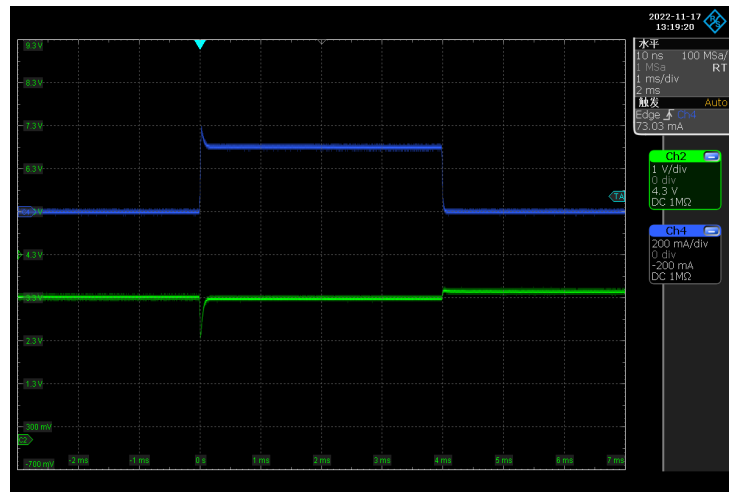

7 Specifications

7.6 Typical Characteristics (continued)

CJ6330 Series ($C_{IN} = 1.0\mu\text{F}$, $C_{OUT} = 1.0\mu\text{F}$, $T_A = 25^\circ\text{C}$, unless otherwise specified)

$I_{OUT}: 10 \sim 150\text{mA}$

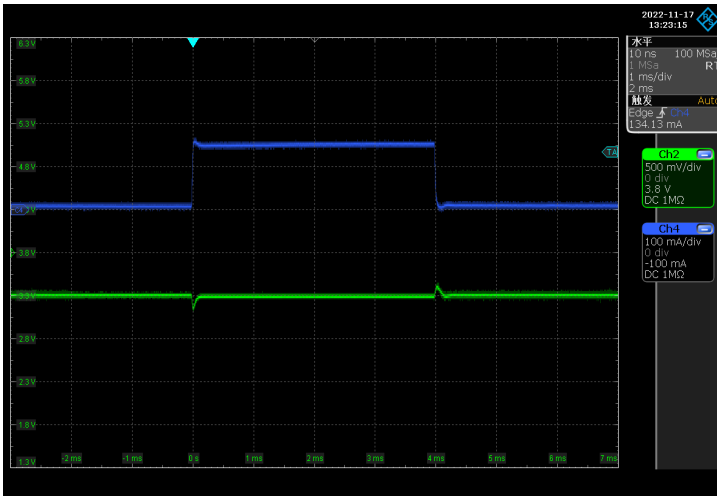

$I_{OUT}: 50 \sim 250\text{mA}$

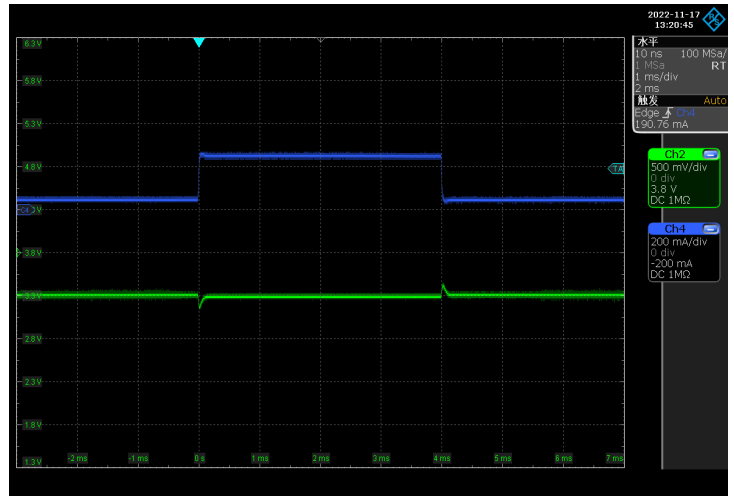

$V_{OUT} = 5.0\text{V}$, $V_{IN} = V_{EN} = V_{OUT} + 1\text{V}$, CH2: V_{OUT} , CH4: I_{OUT}

$I_{OUT}: 0 \sim 100\text{mA}$

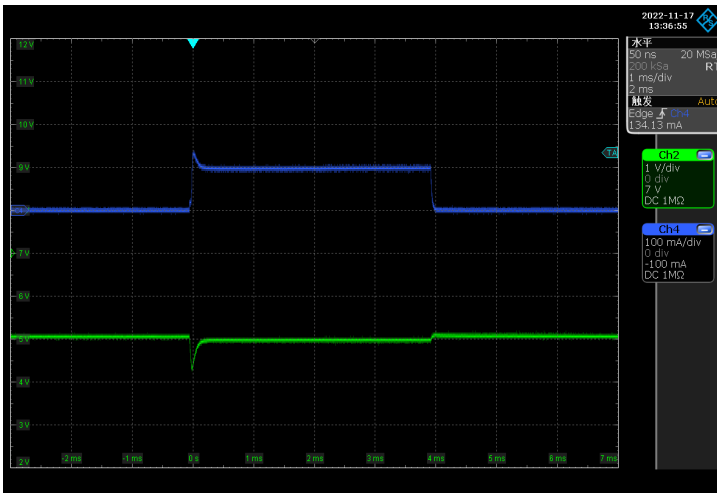

$I_{OUT}: 0 \sim 300\text{mA}$

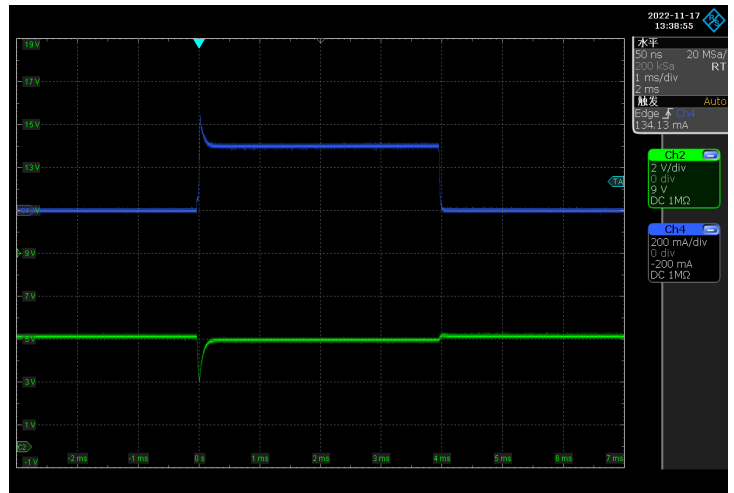

$I_{OUT}: 10 \sim 150\text{mA}$

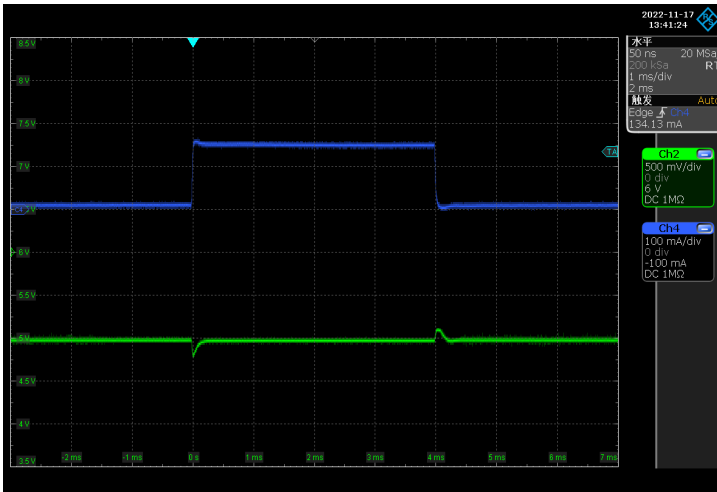

$I_{OUT}: 50 \sim 250\text{mA}$

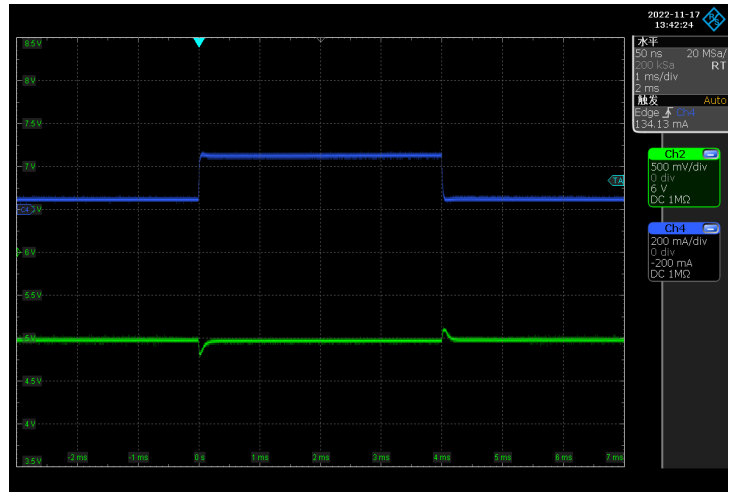

7 Specifications

7.6 Typical Characteristics (continued)

CJ6330 Series ($C_{IN} = 1.0\mu F$, $C_{OUT} = 1.0\mu F$, $T_A = 25^\circ C$, unless otherwise specified)

EN High & EN Low

$V_{IN} = V_{OUT} + 1V$, $V_{EN} = 0 \sim (V_{OUT} + 1)V$, $I_{OUT} = 0mA$, CH2: V_{OUT} , CH3: V_{EN}

EN high

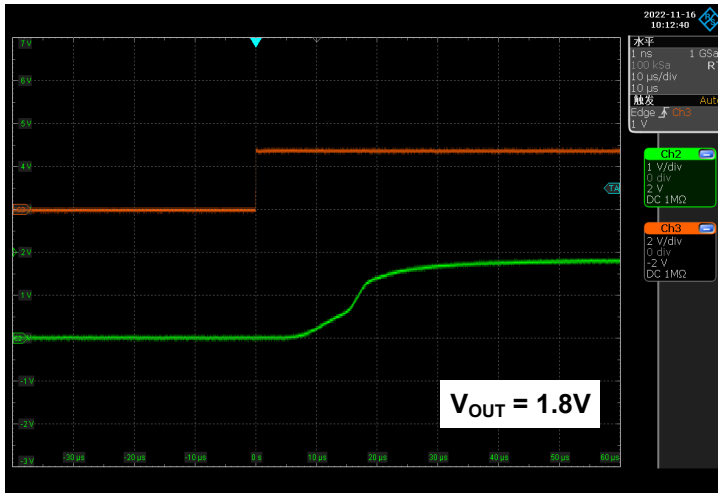

EN low

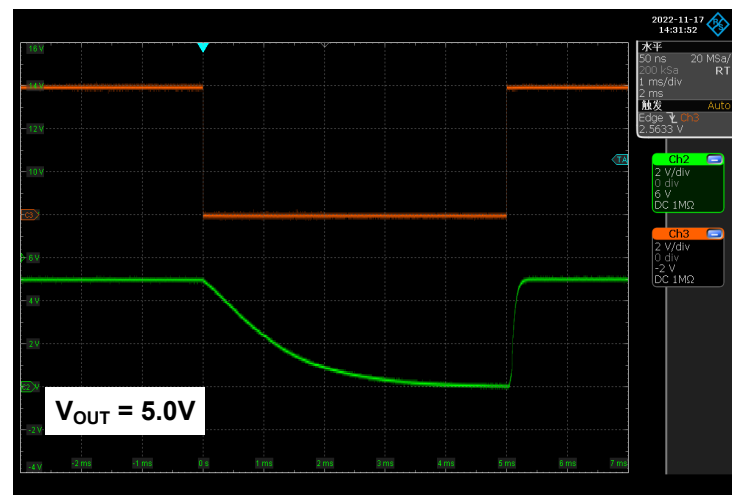
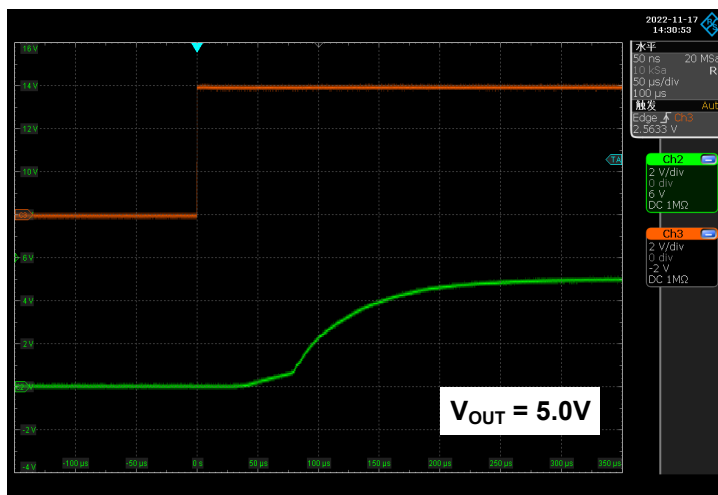
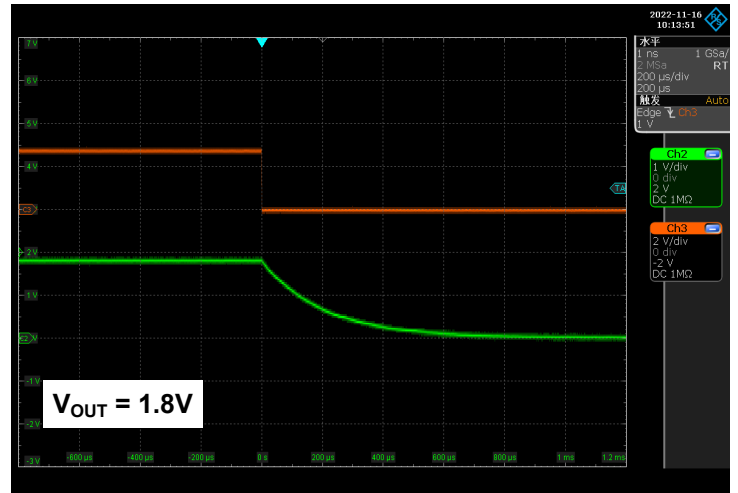

7 Specifications

7.6 Typical Characteristics (continued)

CJ6330 Series ($C_{IN} = 1.0\mu F$, $C_{OUT} = 1.0\mu F$, $T_A = 25^\circ C$, unless otherwise specified)

Power On

$V_{EN} = V_{IN}$, $V_{IN} = 0 \sim (V_{OUT} + 1)V$, CH1: V_{IN} , CH2: V_{OUT}

$V_{OUT} = 1.8V$, $I_{OUT} = 10mA$

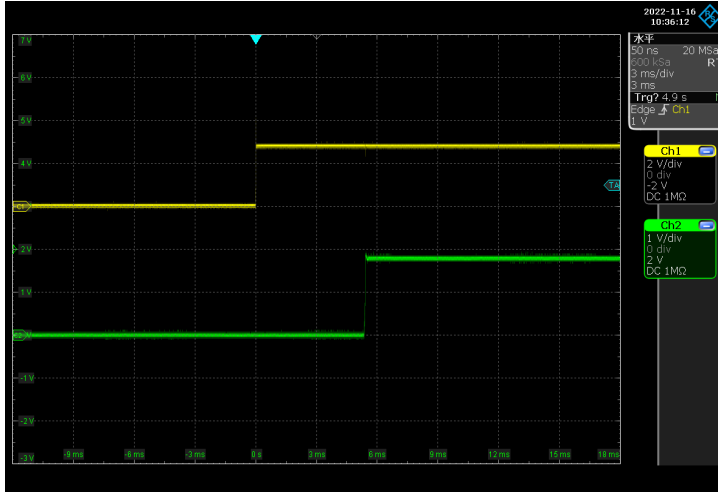

$V_{OUT} = 1.8V$, $I_{OUT} = 50mA$

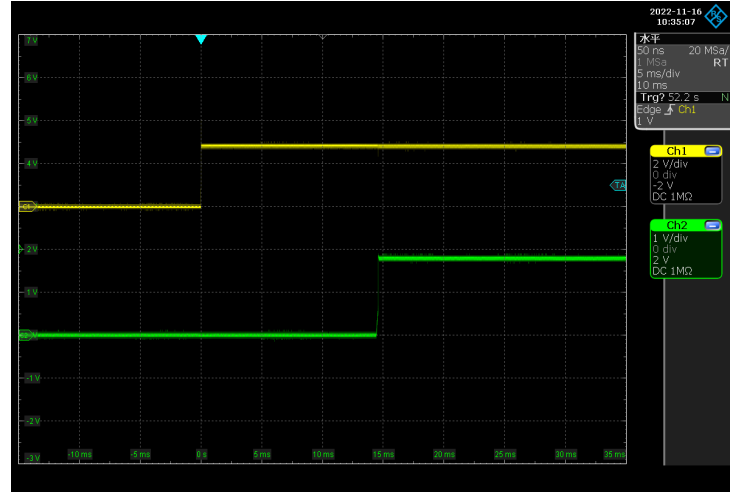

$V_{OUT} = 3.3V$, $I_{OUT} = 10mA$

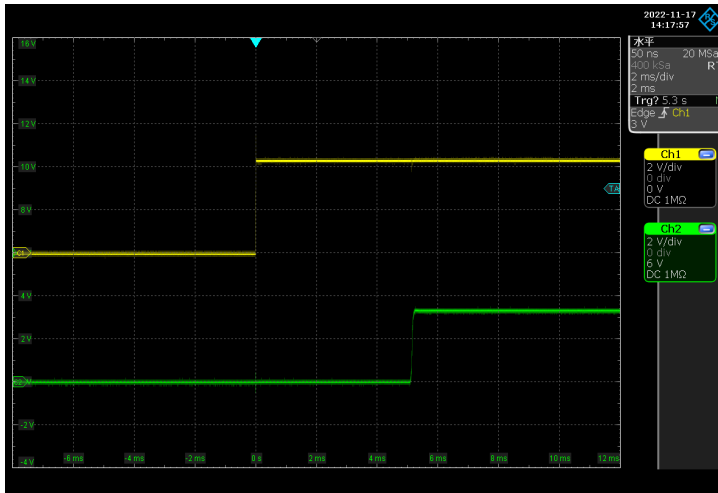

$V_{OUT} = 3.3V$, $I_{OUT} = 50mA$

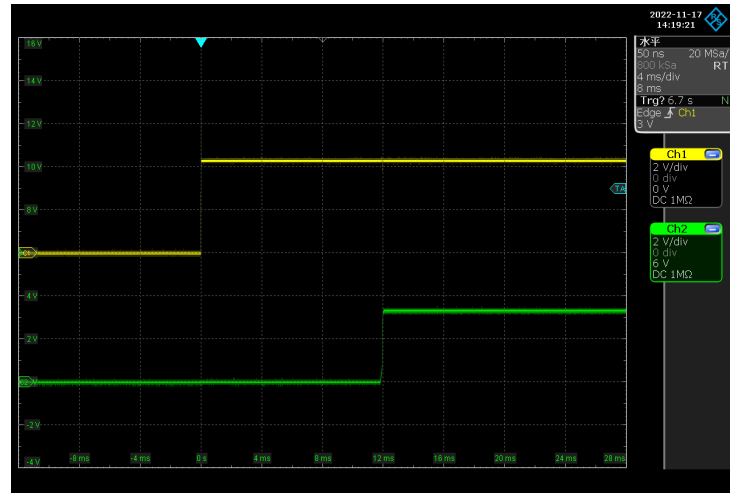

$V_{OUT} = 5.0V$, $I_{OUT} = 10mA$

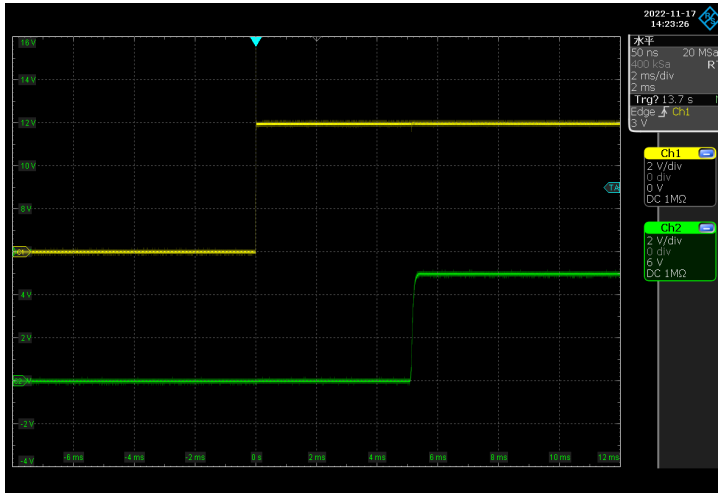

$V_{OUT} = 5.0V$, $I_{OUT} = 50mA$

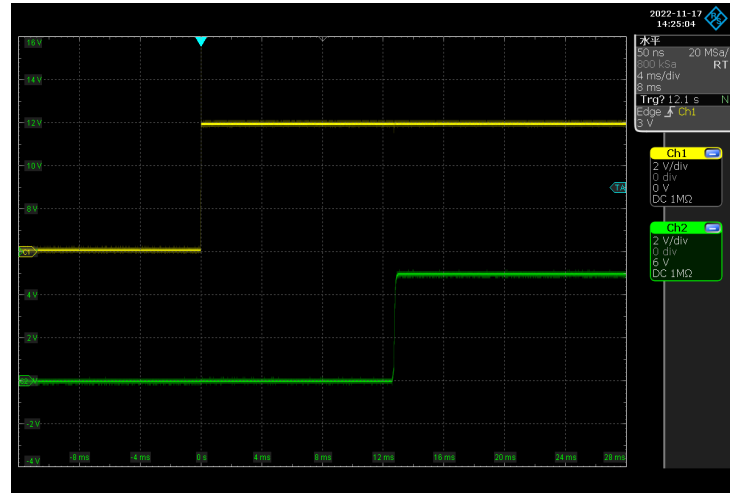

8 Detailed Description

8.1 Description

The CJ6330 series is a group of 18V, low-power consumption, low-dropout linear regulators (LDO). The CJ6330 series supports fixed voltage output from 1.2V to 5.0V, which enables it to use fewer external components to provide better accuracy. The CJ6330 series has low I_Q performance and is internally integrated with current limiting, short-circuit protection and thermal shutdown protection, which makes it an ideal choice for battery power or line power applications.

8.2 Functional Block Diagram

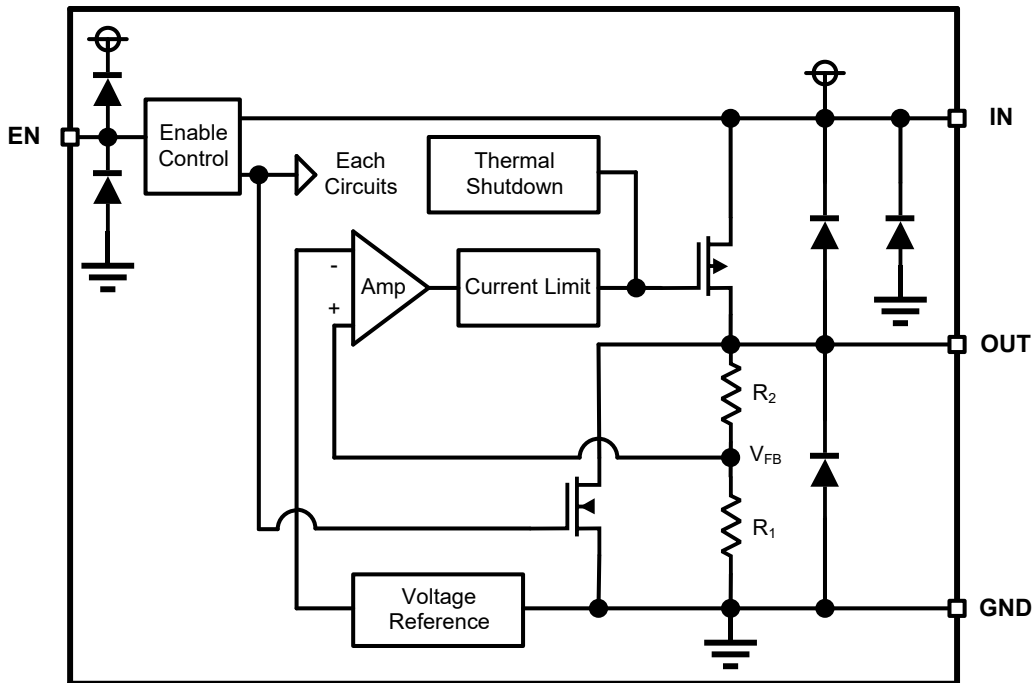

The internal feedback resistors R_1 and R_2 form a voltage divider circuit to compare the V_{FB} input error amplifier with the reference voltage. The internal regulator tube (PMOS) will control its conduction degree through the grid voltage provided by the error amplifier output, which will make the output voltage V_{OUT} not affected by temperature changes or input voltage changes to a certain extent, thus maintaining the stability of the device output voltage.

8 Detailed Description

8.3 Feature Description

Power Supply Input

When the input voltage is lower than the rated range of the data sheet, the device will lose the regulation function of stabilizing the output voltage, that is, it is unable to maintain the output voltage within the rated range. At this time, compared with normal operation, the quiescent current of the device may exceed the rated range, and the transient response performance may be seriously degraded.

When the input voltage is higher than the rated range of the data sheet, the device may cause irreversible damage or failure due to exceeding the maximum rated range of electrical stress.

For the rated input voltage of the device, see *Recommended Operating Conditions* and *Dropout Voltage*.

Output Current

When the circuit design is appropriate, the CJ6330 series can reach the maximum load capacity of at least 300mA. According to the power dissipation of the package and the effective connection thermal resistance with the environment, selecting the appropriate package for the circuit design can make the device emit more heat energy.

Built-in Current Limit & Short Circuit Protection

The CJ6330 series has an internal current limiting circuit, which can protect the device by limiting the load current value in case of instantaneous high load current. When the current limiting is triggered, the output voltage is not regulated. If the out pin of the regulator is short circuited, the internal current limiting circuit will be triggered, the output current of the device will maintain at a relatively small value to protect the device. The typical value of short current I_{short} can be found in *Electrical Characteristics*. The current limiting state will continue until the load current drops to the normal range.

When the load current of the device is large, the device will generate more heat due to the increase of power consumption, which may cause the device to turn off its output due to the internal thermal shutdown protection before the current limit is triggered.

In order to ensure the normal operation of current limit, the inductance of input and load shall be minimized. Continuous operation under current limit is not recommended.

The current limit mode of the CJ6330 series is fold-back current limit. Please refer to the *Fold-back Current Limit* for more details.

Thermal Shutdown

The CJ6330 series has thermal shutdown protection mechanism. When the junction temperature (T_J) of the internal main channel MOSFET exceeds the thermal shutdown threshold temperature (T_{SD}), thermal shutdown will be triggered. At this time, the output will be turned off to prevent catastrophic damage to the chip due to accidental heating. When the T_J drops to a certain range of thermal shutdown threshold temperature (ΔT_{SD}), the thermal shutdown will be released and the device will return to the normal output. The temperature threshold of device triggering thermal shutdown (T_{SD}) and temperature range to be lowered to released from thermal shutdown (ΔT_{SD}) can be found in the *Electrical Characteristics*.

To ensure reliable operation, please limit the junction temperature to the specified range of *Recommended Operating Conditions* in the data sheet. Applications that exceed the recommended temperature range may cause the device to exceed its operating specifications.

Although the internal protection circuit of the device is designed to prevent overall thermal conditions, it is not intended to replace proper power dissipation. Running the device continuously until thermal shutdown or higher than the recommended operating T_J will reduce long-term reliability.

8 Detailed Description

8.3 Feature Description (continued)

Dropout Voltage

Dropout voltage (V_{DO}) refers to the minimum voltage difference between input and output ($V_{IN} - V_{OUT}$) to make the device output voltage reach the rated range at rated current. When the dropout voltage condition required by the device is reached, the internal MOSFET will be fully turned on, at this time, the MOSFET is equivalent to a switch for regulation.

The V_{DO} increases with the increase of load current. Since $V_{IN} - V_{OUT}$ must be no less than the V_{DO} , the V_{DO} indirectly specifies the minimum input voltage of devices under different load current conditions. If the $V_{IN} - V_{OUT}$ is less than the V_{DO} , the performance of the device may deteriorate (see *Operation in Dropout Mode* for details).

Enable Control

The enable pin of the device (EN) is active at high level. When the voltage of the EN is greater than the EN logic high voltage ($V_{EN\ H}$), the device will be enabled and maintain the normal output. When the voltage of the EN is lower than the EN logic low voltage ($V_{EN\ L}$), the internal circuit of the device will be disabled and the output will be turned off, the device will be in the standby mode until EN is turned to high level again. The $V_{EN\ H}$ and $V_{EN\ L}$ can be found in the *Electrical Characteristics*.

Normal startup waveform and startup slope rate control can be ensured when the device starts from any low voltage lower than $V_{EN\ L}$, but the discharge time of output capacitor must be taken into account. EN can not be float, if EN is not required to control the output voltage independently, connect EN to IN.

Auto-discharge Function

The device with enable control has an auto-discharge circuit. When the enable control is turned off, the device will be disabled. An internally integrated pull-down MOSFET (see *Functional Block Diagram*) will connect a resistor ($R_{Discharge}$) to the ground to release the charge in the output capacitor, thus closing the entire device circuit. The value of $R_{Discharge}$ can be found in the *Electrical Characteristics*. The discharge time of the output capacitor after the device is disabled is determined by the output capacitance (C_{OUT}) and load resistance (R_L) in parallel with the $R_{Discharge}$. The time constant τ can be calculated by the following formula:

$$\tau = C \times R_{Discharge} \quad (R_L = 0)$$

$$\tau = C \times \left(\frac{R_L \times R_{Discharge}}{R_L + R_{Discharge}} \right) \quad (R_L \neq 0)$$

The output voltage after discharging through pull-down MOSFET can be calculated by the following formula:

$$V = V_{OUT} \times e^{-\frac{t}{\tau}}$$

$$t = \tau \times \ln\left(\frac{V}{V_{OUT}}\right)$$

Where, V is the output voltage after discharge, V_{OUT} is the output voltage, t is the discharge time, τ is the discharge time constant.

Do not rely on the active discharge circuit to release a large amount of output capacitance after the input power supply crashes, because the reverse current can flow from the output to the input. This reverse current may damage the device. The limiting reverse current shall not exceed 5% of the rated current of the device.

9 Application and Implementation

9.1 Typical Application Circuits

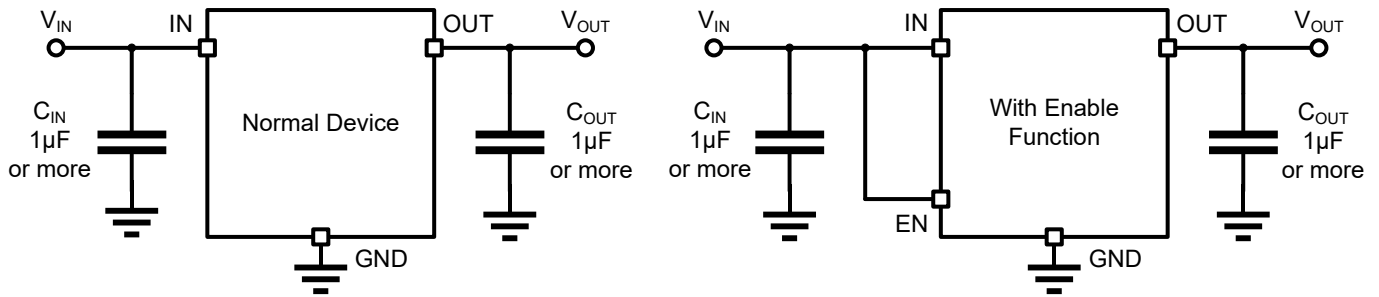

9.2 Application Information

Selection of Bypass Capacitances

For the CJ6330 series, it is recommended to use 1µF input (C_{IN}) and output (C_{OUT}) ceramic capacitors.

Type of Capacitors:

Since any leakage of the capacitor will increase the quiescent power consumption of the whole circuit, attention should be paid to selecting capacitors with low leakage. When designing the circuit of portable equipment including CJ6330 series, due to the shortage of tantalum capacitors, it is a good choice to use small size, low equivalent series resistance (ESR) and high RMS current capacity multilayer ceramic capacitors (MLCC) in the DC to DC voltage conversion. The designer must choose the appropriate capacitor type for circuit design: X7R- Ceramic capacitors of X5R- and COG- rated dielectric materials can provide relatively good capacitance stability within the temperature range, Y5V- type capacitors are not recommended because of large changes in capacitance values. However, no matter which type of ceramic capacitor is selected, the effective capacitance may vary with the operating voltage and temperature. The designer must consider the influence of the change of the effective value of capacitance according to the circuit design and application conditions.

Input Capacitors (C_{IN}):

It is recommended to use a 1µF capacitor at the input pin of the device, and the position of the input capacitor should be as close to the device input pin as possible.

For the CJ6330 series, the input capacitor is not necessary to maintain the output stability, but it can offset the reactive input source and improve the transient response, input ripple and PSRR performance of the device.

It should be noted that although many types of capacitors can be used for input bypass, using ceramic capacitors for input filtering may cause problems. Due to the self resonance and high Q characteristics of some types of ceramic capacitors, under certain starting conditions, applying voltage steps to ceramic capacitors may lead to large current surges (such as directly connecting the input pin of LDO to the power supply), which may cause some energy stored in the parasitic inductance of the power lead. When the stored energy is transferred from these inductors to ceramic capacitors, large voltage spikes may occur in the circuit. These voltage spikes are easily twice the step amplitude of the input voltage, and are likely to bring potential risks to the normal operation and reliability of the device. Therefore, the selection of ceramic capacitors as input capacitors must be careful. Adding 3Ω resistors and X5R- type ceramic capacitors will minimize voltage transients during startup. A higher value capacitor may be necessary if large, fast rise-time load or line transients are anticipated or if the device is located several inches from the input power source.

9 Application and Implementation

9.2 Application Information (continued)

Selection of Bypass Capacitances (continued)

Output Capacitors (C_{OUT}):

Recommended 1 μ F output ceramic capacitor to keep the device output stable, and the capacitor position should be as close to the device pin as possible.

For CJ6330 series, the device needs an output capacitor to achieve loop stability. As with any regulator, a larger output capacitance reduces the peaks during a load transient but slows down the response time of the device. The proper capacitor can help to obtain better dynamic performance.

Transient Response

Transient response refers to the change of system output from initial state to stable state under the action of typical signal input. For LDO, the designer should pay attention to the possible impact of linear transient response and load transient response on the system: linear transient response refers to the transient response of output to change when the input voltage changes, while load transient response refers to the transient response of output to change when the output current changes. The specific phenomenon is that the output voltage of the device will have a short spike, especially when the input voltage or output current changes greatly in a short time. This change is not only related to the performance of the chip itself, but also related to the change of output current, change rate and output capacitance:

1. When the output current increases, the output voltage of the device will decrease to a certain extent, and the larger output current will provide a higher current discharge path for the output capacitor, which will affect the peak value generated by the transient spike and reduce the peak value;
2. The output current or input voltage changes relatively slowly, and the output change of the device is relatively small, affecting the spike caused by the change;
3. The use of large input and output capacitors can reduce the spike caused by transient response to a certain extent to improve the transient performance, but large output capacitors can also affect the response time of devices.

For the selection of bypass capacitance value, refer to the *Section of Bypass Capacitances* selection.

Operation in Dropout Mode

The CJ6330 series is internally integrated with a P-MOSFET to achieve low dropout voltage. The voltage difference between the input and the output ($V_{IN} - V_{OUT}$) of the device must not be lower than the corresponding dropout voltage (V_{DO}) to ensure that the output voltage tolerance is within the rated range of the data sheet. The dropout voltage will increase with the increase of load current. When the $V_{IN} - V_{OUT}$ is less than the V_{DO} , the P-MOSFET inside the device is in a linear state, the resistance from the input pin to the output pin is equal to the resistance from the drain to the source of the P-MOSFET, and the device functions like a resistor. When operating in this state, the response time of the error amplifier inside the device will be limited, which will seriously degrade the transient performance of the device, when the external circuit has a transient change, the deviation of the output voltage will become larger than the normal operating state. In addition, the PSRR and noise performance of the device will be worse than that under normal operating conditions.

9 Application and Implementation

9.2 Application Information (continued)

Fold-back Current Limit

The CJ6330 series adopts the fold-back current limit. The following is some application information of the fold-back current limit.

Current Limit Type:

Current limit can impose certain restrictions on the current value provided by the device. Compared with the so-called "brick-wall" current limiting mode, the significant difference of the fold-back current limit is that overload and short circuit are obviously different. Figure 9-1 and Figure 9-2 show the typical operating characteristics of these two current limiting mechanisms.

1. Operating characteristic curve R1 represents the curve of linear resistance as load under normal working condition;
2. When the linear resistance as the load gradually decreases and causes the device to enter the overload state, the operating characteristic curve is shown in R2;
3. When the linear resistance decreases to 0Ω , the device will enter the short-circuit state, and the operating characteristic curve is shown in R3.

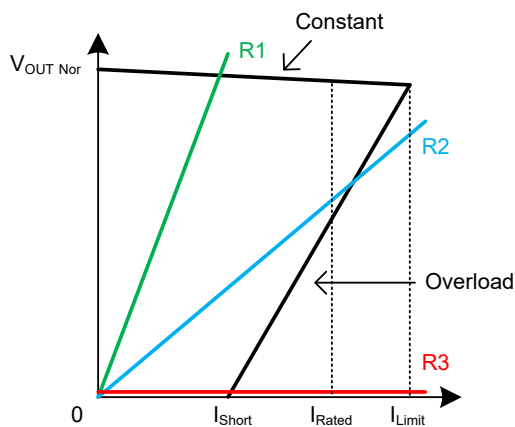

Figure 9-1. Fold-back Current Limit

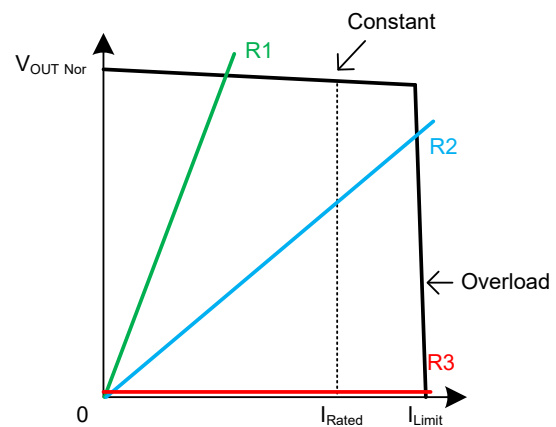

Figure 9-2. Brick-wall Current Limit

After entering the short circuit state, the short-circuit current of the "brick-wall" type current limiting mechanism is limited to I_{Limit} , and the reliability and stability of the voltage regulator may be affected due to the large amount of heat generated during the short circuit, while the I_{Short} of fold-back current limit in the short circuit state is far lower than I_{Limit} , which can reduce the heat energy generated due to power dissipation during the device short circuit. The fold-back current limit allows the device to limit the short circuit current to a small current value without losing the rated range of output current. This is very important if continuous short circuit faults need to be solved.

The current limiting mechanism limits the maximum load current of the device, and the internal transmission transistor of the device will not move outside its safe operation area (SOA) during operation. See *Recommended Continuous Operating Areas* for details.

9 Application and Implementation

9.2 Application Information (continued)

Fold-back Current Limit (continued)

Usage and Precautions:

When using the voltage regulator with the fold-back current limit, it should be noted that the device cannot be started normally under certain loads because the short-circuit current of the fold-back current limit is obviously different from the maximum load current. As shown in the curves **S1** and **S2** in Figure 9-3, the nonlinear load **S1** is distributed in the range of the load curve region where the device can work, because the current provided by the device is always greater than the requirements of the load under all voltage conditions, the device can start normally, and the output will reach the ideal operating point P_1 ; The situation of nonlinear load **S2** is different, during actual startup, when the voltage and current are gradually rising, the output of **S2** will be limited at P_2 , because the device cannot provide more current under the voltage at P_2 , which will make the output stuck at the intersection and maintain at this level, and the device cannot reach the ideal operating point P_3 for normal startup.

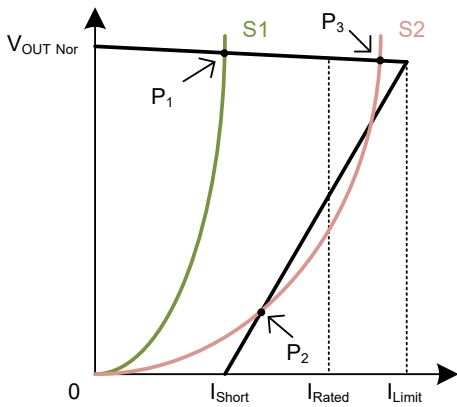

Figure 9-3. Nonlinear Load Example

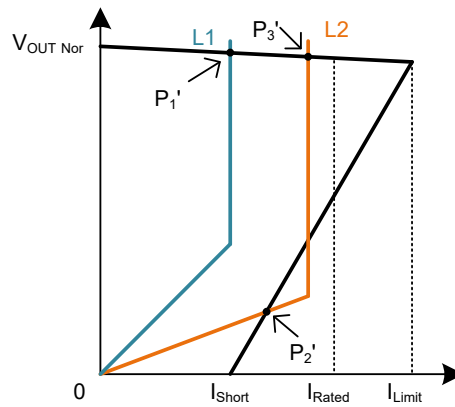

Figure 9-4. Active Load Profile

In addition, many typical cases of actual loads have operating characteristics as shown in **L1** and **L2** curves in Figure 9-4. When the device starts from zero with **L1** and **L2** as loads, the load will behave as a linear resistance, and the load current will change to a constant value after reaching the inflection point voltage. Like nonlinear loads **S1** and **S2**, when **L1** is used as the load, the device can start normally and reach the ideal working point P_1' , while when **L2** is used as the load, the device cannot start normally, and the output will be stuck at P_2' and cannot reach the ideal working point P_3' .

As an active load, the electronic load has the same operating characteristics as **L1** and **L2**. Some problems may occur when using the electronic load to test the voltage regulator with a fold-back current limit. See *Test Current Limit* for more details.

For the load with specific operating characteristics as shown in **S2** and **L2** curves, it is necessary to use a fold-back current limiting device with a higher I_{Short} , or a voltage stabilizing device with a "brick-wall" type current limiting.

9 Application and Implementation

9.2 Application Information (continued)

Test Current Limit

The CJ6330 series uses the fold-back current limit. When testing this kind of linear voltage regulator with the fold-back current limit, it should be noted that using the electronic load that is very common in the laboratory as the load of the voltage regulator may cause some problems:

1. When the constant current mode (CC) is used for testing, when the load current is higher than the short circuit current (I_{Short}), the device may not be able to start normally from 0V, because the CC mode of the electronic load has similar operating characteristics as the L2 curve described in the fold-back current limit. Moreover, in the CC mode, the internal circuit of the electronic load will try to pull down the output voltage below the ground. A feasible method is to start the device with no load first, and then switch to the required steady state current. A constant resistance (CR) load mode using an electronic load may help, but this may lead to the following other problems.
2. When using the CC mode of the electronic load to test the current limiting behavior, the negative feedback loop with constant internal control current of the electronic load will conflict with the current limiting loop of the device and may cause faults. When the CR mode is used for testing, the complex control loop inside the electronic load that keeps the load resistance constant will interact with the regulator and may oscillate at the output.

The above are some problems that may occur when using electronic load to test the voltage regulator. Using actual resistance as the load is a good solution. When testing the I_{Limit} , the variable resistor can be used as the load. First, set the resistance value of the variable resistor to be large enough so that the output current of the device under test at this time is significantly less than the current at full load, then gradually reduce the load resistance until the output voltage exceeds the specified range, and the load current at this time is the maximum load current. The specified range of output voltage depends on the range that the user thinks can be accepted and the current regulation rate of the voltage regulator. When some voltage regulators are in the fold-back current limit state, the output voltage drops rapidly. For these devices, the load current before the output voltage drops should be considered as the maximum load current. The measurement of short circuit current can be realized by shorting the output or connecting the load resistance of 0Ω .

Compared with the electronic load, the variable resistor may not be so convenient, but the use of variable resistor for current limiting measurement is the only way to ensure that there is no bad interaction between the load and the voltage regulator. If it is necessary to measure the starting characteristics of the device, a variable resistor must be used.

Recommended Continuous Operating Areas

As an LDO, the working area of CJ6330 series is limited by dropout voltage, output current, junction temperature and input voltage under continuous working condition. The recommended areas for continuous operation are shown in Figure 9-5:

- A. The LDO input and output voltage difference $V_{IN} - V_{OUT}$ must meet the dropout voltage V_{DO} conditions. See *Dropout Voltage* for more details.
- B. Rated output current range I_{Rated} .
- C. The actual junction temperature T_J of LDO shall not exceed the rated junction temperature. The product of voltage difference and current at both ends of LDO is power consumption, which determines the actual working junction temperature of LDO, so the curve is not linear.

In addition, the working area of CJ6330 series is limited by the rated $V_{IN MIN}$ and $V_{IN MAX}$.

9 Application and Implementation

9.2 Application Information (continued)

Recommended Continuous Work Areas (continued)

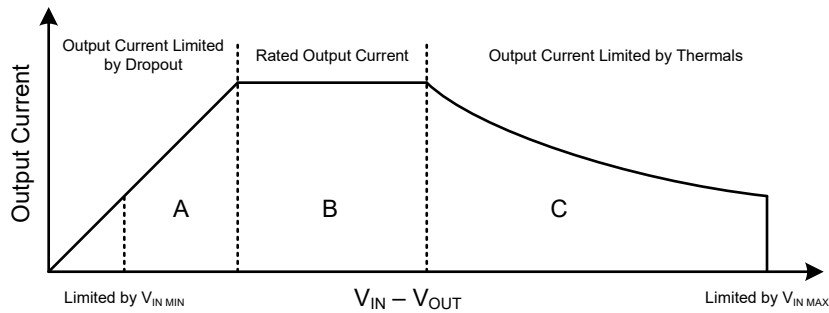

Figure 9-5. Region Description for Continuous Operation

9.3 Power Supply Recommendation

The CJ6330 series is designed to operate within the input power supply voltage range of 2.5V to 18V. The input power supply should be well adjusted and have low noise. If the input power supply has high noise, it is recommended to use an additional bypass capacitor at the input to improve the output noise performance of the device. It is recommended to use an input capacitor of 1 μ F or higher to reduce the impedance of the input power supply, especially during transients.

9.4 Layout Guidelines

When designing the circuit including CJ6330 series, the following matters should be noted:

- Place the input and output capacitors as close to the pins of the device as possible;
- The device is connected by copper plane and the heat sink (or back pad) of the device is fully welded with PCB to obtain better heat dissipation performance and lower on resistance;
- Heat sink holes are placed around the device to help the circuit dissipate more heat energy. However, attention should be paid to the position of the heat sink holes to prevent the solder (or solder paste) on the IC pad from being absorbed by the heat sink holes and being damaged during welding.

NOTE

The application information in this section is not part of the data sheet component specification, and JSCJ makes no commitment or statement to guarantee its accuracy or completeness. Customers are responsible for determining the rationality of corresponding components in their circuit design and making tests and verifications to ensure the normal realization of their circuit design.

10 Mechanical Information

10.1 SOT-23-3L Mechanical Information

SOT-23-3L Outline Dimension

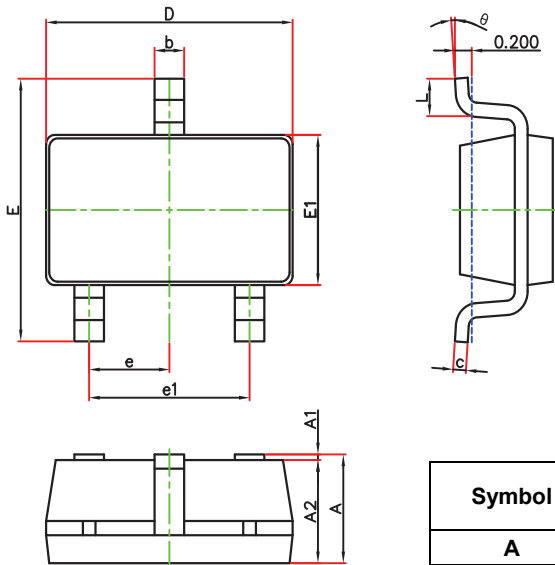

Symbol	Dimensions In Millimeters		Dimensions In Inches	
	Min.	Max.	Min.	Max.
A	1.050	1.250	0.041	0.049
A1	0.000	0.100	0.000	0.004
A2	1.050	1.150	0.041	0.045
b	0.300	0.500	0.012	0.020
c	0.100	0.200	0.004	0.008
D	2.820	3.020	0.111	0.119
E	2.650	2.950	0.104	0.116
E1	1.500	1.700	0.059	0.067
e	0.950(BSC)		0.037(BSC)	
e1	1.800	2.000	0.071	0.079
L	0.300	0.600	0.012	0.024
θ	0°	8°	0°	8°

SOT-23-3L Suggested Pad Layout

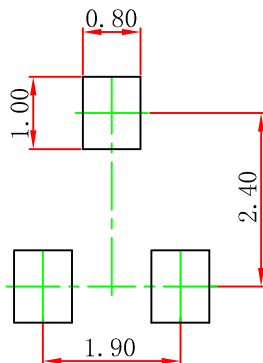

Note:

1. Controlling dimension: in millimeters.
2. General tolerance: ±0.05mm.
3. The pad layout is for reference purpose only.

10 Mechanical Information

10.2 SOT-89-3L Mechanical Information

SOT-89-3L Outline Dimensions

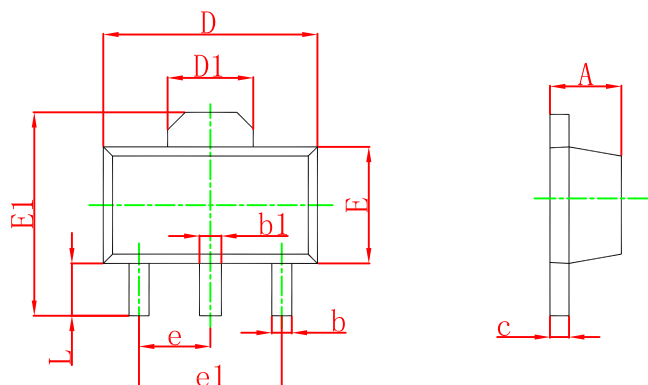

Symbol	Dimensions In Millimeters		Dimensions In Inches	
	Min.	Max.	Min.	Max.
A	1.400	1.600	0.055	0.063
b	0.320	0.520	0.013	0.197
b1	0.400	0.580	0.016	0.023
c	0.350	0.440	0.014	0.017
D	4.400	4.600	0.173	0.181
D1	1.550 REF		0.061 REF	
E	2.300	2.600	0.091	0.102
E1	3.940	4.250	0.155	0.167
e	1.500 TYP		0.060 TYP	
e1	3.000 TYP		0.118 TYP	
L	0.900	1.200	0.035	0.047

SOT-89-3L Suggested Pad Layout

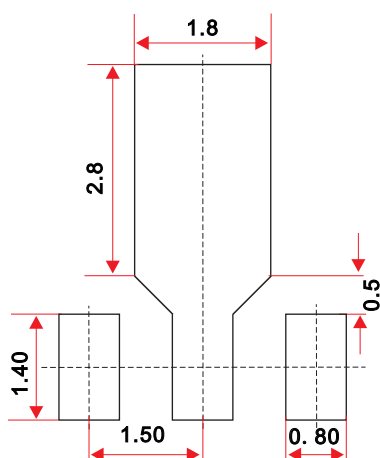

Note:

1. Controlling dimension: in millimeters.
2. General tolerance: $\pm 0.05\text{mm}$.
3. The pad layout is for reference purpose only.

10 Mechanical Information

10.3 SOT-223 Mechanical Information

SOT-223 Outline Dimensions

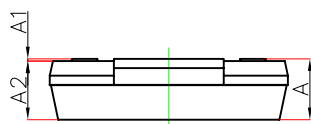
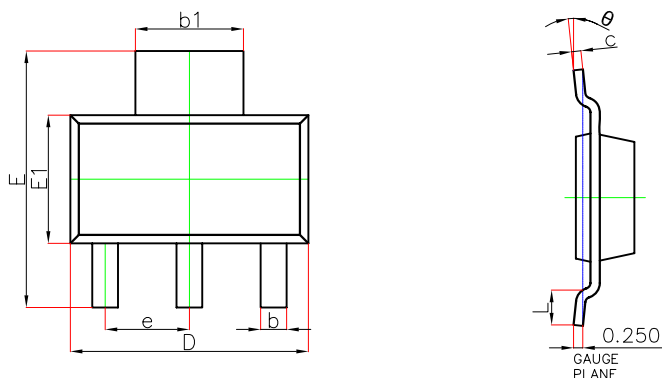

Symbol	Dimensions In Millimeters		Dimensions In Inches	
	Min.	Max.	Min.	Max.
A	—	1.800	—	0.071
A1	0.020	0.100	0.001	0.004
A2	1.500	1.700	0.059	0.067
b	0.660	0.840	0.026	0.033
b_1	2.900	3.100	0.114	0.122
c	0.230	0.350	0.009	0.014
D	6.300	6.700	0.248	0.264
E	6.700	7.300	0.264	0.287
E1	3.300	3.700	0.130	0.146
e	2.300(BSC)		0.091(BSC)	
L	0.750	—	0.030	—
θ	0°	10°	0°	10°

SOT-223 Suggested Pad Layout

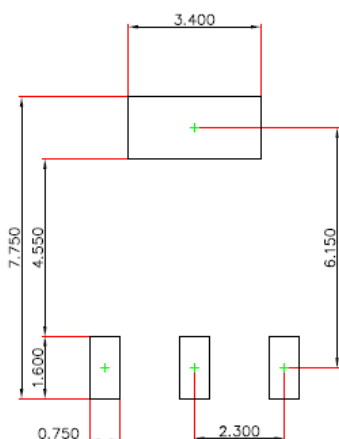

Note:

1. Controlling dimension: in millimeters.
2. General tolerance: $\pm 0.05\text{mm}$.
3. The pad layout is for reference purpose only.

10 Mechanical Information

10.4 SOT-23-5L Mechanical Information

SOT-23-5L Outline Dimensions

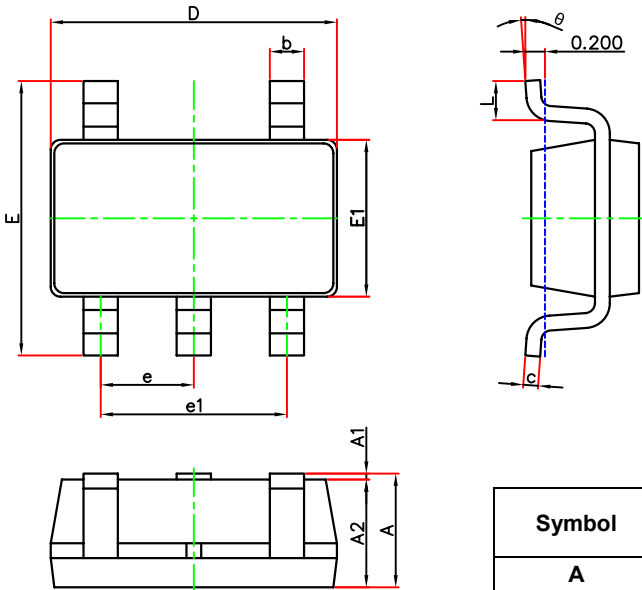

Symbol	Dimensions In Millimeters		Dimensions In Inches	
	Min.	Max.	Min.	Max.
A	1.050	1.250	0.041	0.049
A1	0.000	0.100	0.000	0.004
A2	1.050	1.150	0.041	0.045
b	0.300	0.500	0.012	0.020
c	0.100	0.200	0.004	0.008
D	2.820	3.020	0.111	0.119
E	2.650	2.950	0.104	0.116
E1	1.500	1.700	0.059	0.067
e	0.950(BSC)		0.037(BSC)	
e1	1.800	2.000	0.071	0.079
L	0.300	0.600	0.012	0.024
theta	0°	8°	0°	8°

SOT-23-5L Suggested Pad Layout

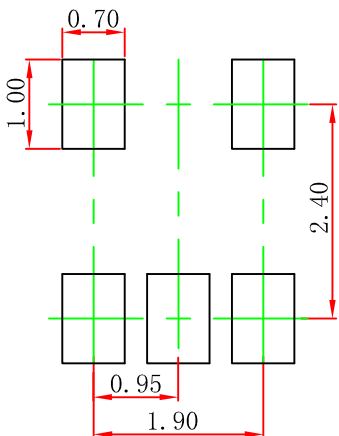

Note:

1. Controlling dimension: in millimeters.
2. General tolerance: ±0.05mm.
3. The pad layout is for reference purpose only.

11 Packaging Information

11.1 SOT-23-3L Tape and Reel Information

SOT-23-3L Embossed Carrier Tape

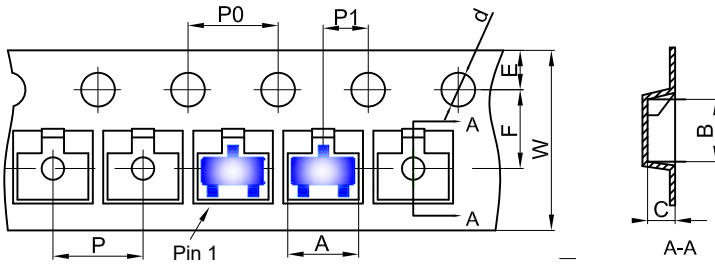

Packaging Description:
 SOT-23-3L parts are shipped in tape. The carrier tape is made from a dissipative (carbon filled) polycarbonate resin. The cover tape is a multilayer film (Heat Activated Adhesive in nature) primarily composed of polyester film, adhesive layer, sealant, and anti-static sprayed agent. These reeled parts in standard option are shipped with 3,000 units per 7" or 18.0cm diameter reel. The reels are clear in color and is made of polystyrene plastic (anti-static coated).

Dimensions are in millimeter										
Pkg type	A	B	C	d	E	F	P0	P	P1	W
SOT-23-3L	3.18	3.28	1.32	Ø1.50	1.75	3.50	4.00	4.00	2.00	8.00

SOT-23-3L Tape Leader and Trailer

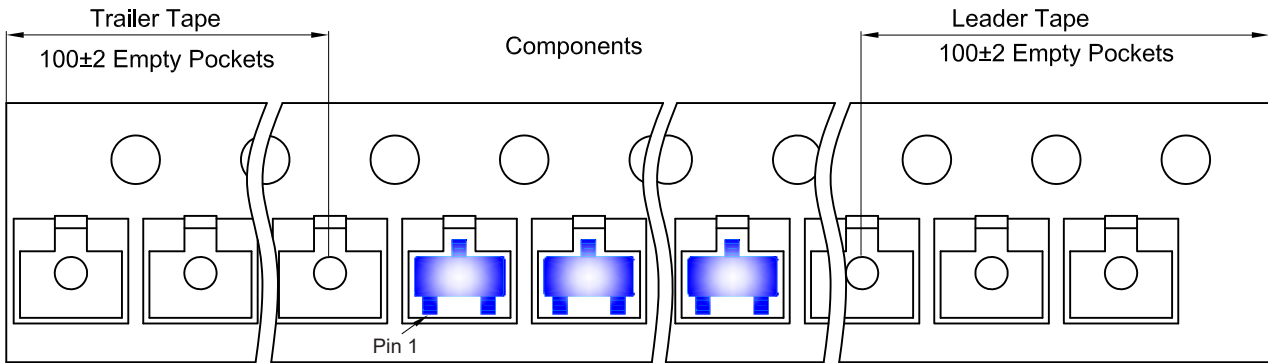

SOT-23-3L Reel

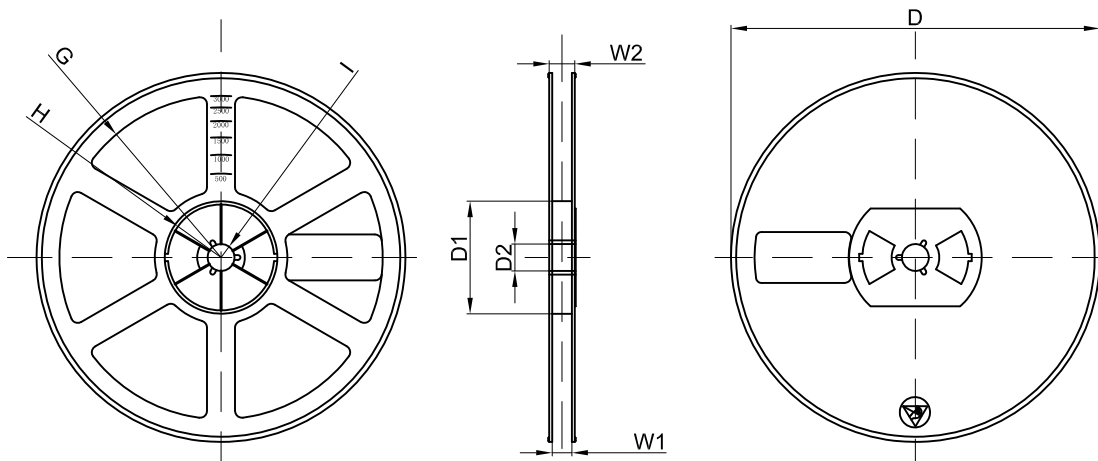

Dimensions are in millimeter								
Reel Option	D	D1	D2	G	H	I	W1	W2
7"Dia	Ø180.00	60.00	13.00	R78.00	R25.60	R6.50	9.50	13.10

REEL	Reel Size	Box	Box Size(mm)	Carton	Carton Size(mm)	G.W.(kg)
3000 pcs	7 inch	30,000 pcs	203×203×195	120,000 pcs	438×438×220	

11 Packaging Information

11.2 SOT-89-3L Tape and Reel Information

SOT-89-3L Embossed Carrier Tape

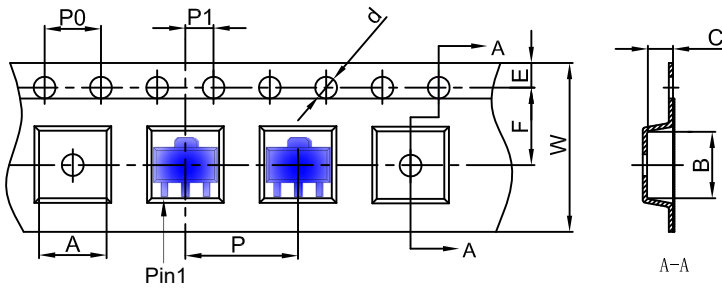

Packaging Description:
 SOT-89-3L parts are shipped in tape. The carrier tape is made from a dissipative (carbon filled) polycarbonate resin. The cover tape is a multilayer film (Heat Activated Adhesive in nature) primarily composed of polyester film, adhesive layer, sealant, and anti-static sprayed agent. These reeled parts in standard option are shipped with 1,000 units per 7" or 18.0 cm diameter reel. The reels are clear in color and is made of polystyrene plastic (anti-static coated).

Dimensions are in millimeter										
Pkg type	A	B	C	d	E	F	P0	P	P1	W
SOT-89-3L	4.85	4.45	1.85	Ø1.50	1.75	5.50	4.00	8.00	2.00	12.00

SOT-89-3L Tape Leader and Trailer

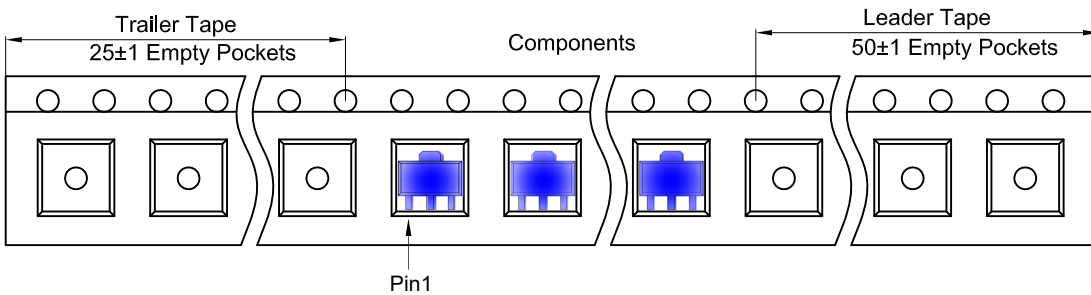

SOT-89-3L Reel

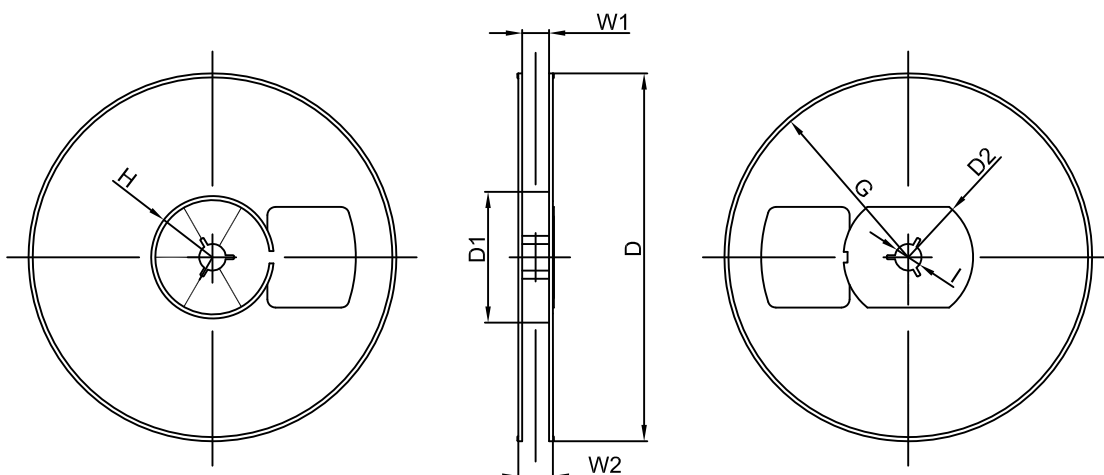

Dimensions are in millimeter								
Reel Option	D	D1	D2	G	H	I	W1	W2
7" Dia	Ø180.00	60.00	R32.00	R86.50	R30.00	Ø13.00	13.20	16.50

REEL	Reel Size	Box	Box Size(mm)	Carton	Carton Size(mm)	G.W.(kg)
1000 pcs	7 inch	10,000 pcs	203×203×195	40,000 pcs	438×438×220	

11 Packaging Information

11.3 SOT-223 Tape and Reel Information

SOT-223 Embossed Carrier Tape

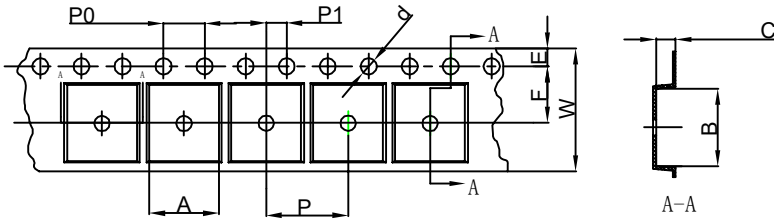

Packaging Description:

SOT-223 parts are shipped in tape. The carrier tape is made from a dissipative (carbon filled) polycarbonate resin. The cover tape is a multilayer film (Heat Activated Adhesive in nature) primarily composed of polyester film, adhesive layer, sealant, and anti-static sprayed agent. These reeled parts in standard option are shipped with 2,500 units per 13" or 33.0cm diameter reel. The reels are clear in color and is made of polystyrene plastic (anti-static coated).

Dimensions are in millimeter										
Pkg type	A	B	C	d	E	F	P0	P	P1	W
SOT-223	6.765	7.335	1.88	Ø1.50	1.75	5.50	4.00	8.00	2.00	12.00

SOT-223 Tape Leader and Trailer

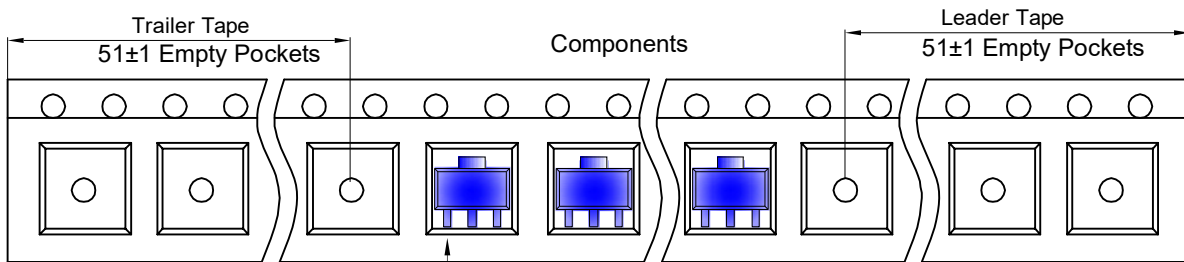

SOT-223 Reel

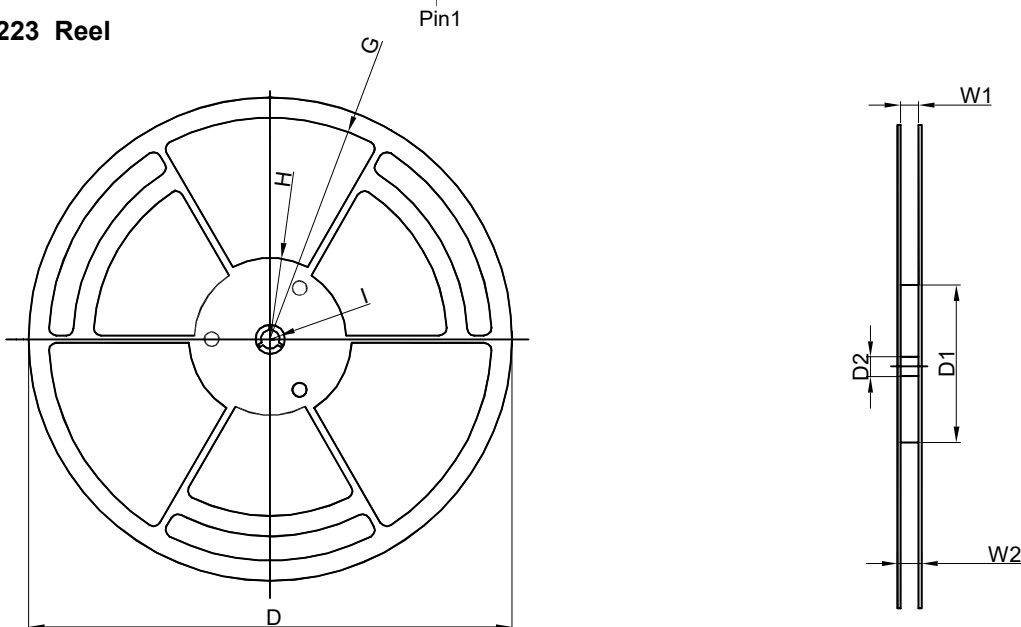

Dimensions are in millimeter								
Reel Option	D	D1	D2	G	H	I	W1	W2
13" Dia	Ø330.00	100.00	13.00	R151.00	R56.00	R6.50	12.40	17.60

REEL	Reel Size	Box	Box Size(mm)	Carton	Carton Size(mm)	G.W.(kg)
2,500 pcs	13 inch	2,500 pcs	336×336×48	20,000 pcs	445×355×365	

11 Packaging Information

11.4 SOT-23-5L Tape and Reel Information

SOT-23-5L Tape and Reel Information

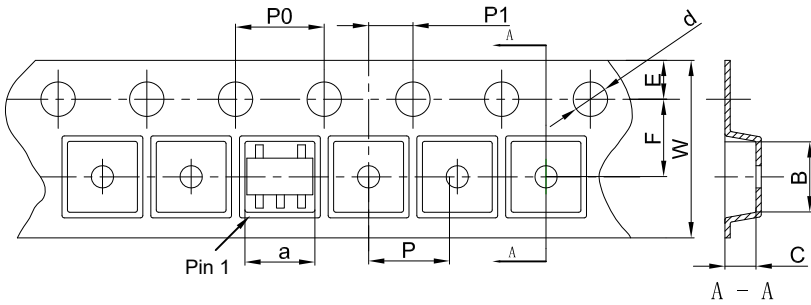

Packaging Description:

SOT-23-5L parts are shipped in tape. The carrier tape is made from a dissipative (carbon filled) polycarbonate resin. The cover tape is a multilayer film (Heat Activated Adhesive in nature) primarily composed of polyester film, adhesive layer, sealant, and anti-static sprayed agent. These reeled parts in standard option are shipped with 3,000 units per 7" or 18.0cm diameter reel. The reels are clear in color and is made of polystyrene plastic (anti-static coated).

Dimensions are in millimeter										
Pkg type	a	B	C	d	E	F	P0	P	P1	W
SOT-23-5L	3.23	3.17	1.37	Ø1.55	1.75	3.50	4.00	4.00	2.00	8.00

SOT-23-5L Tape Leader and Trailer

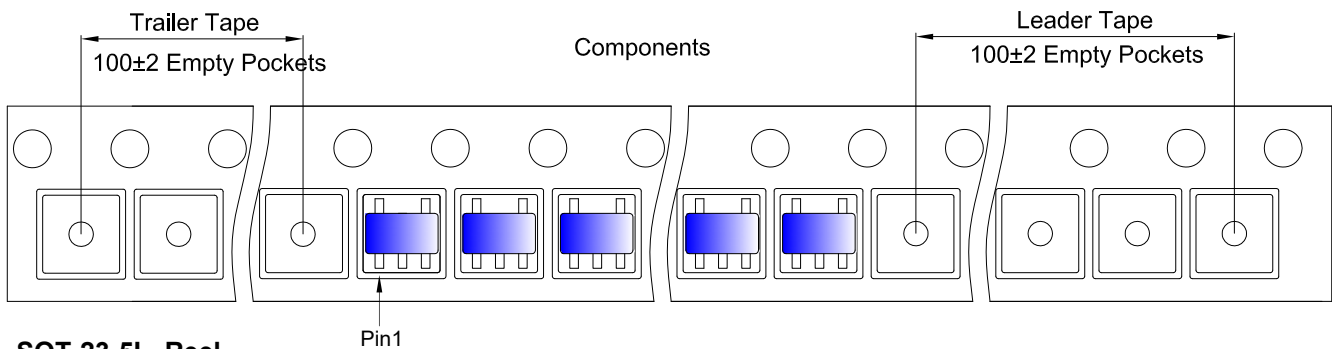

SOT-23-5L Reel

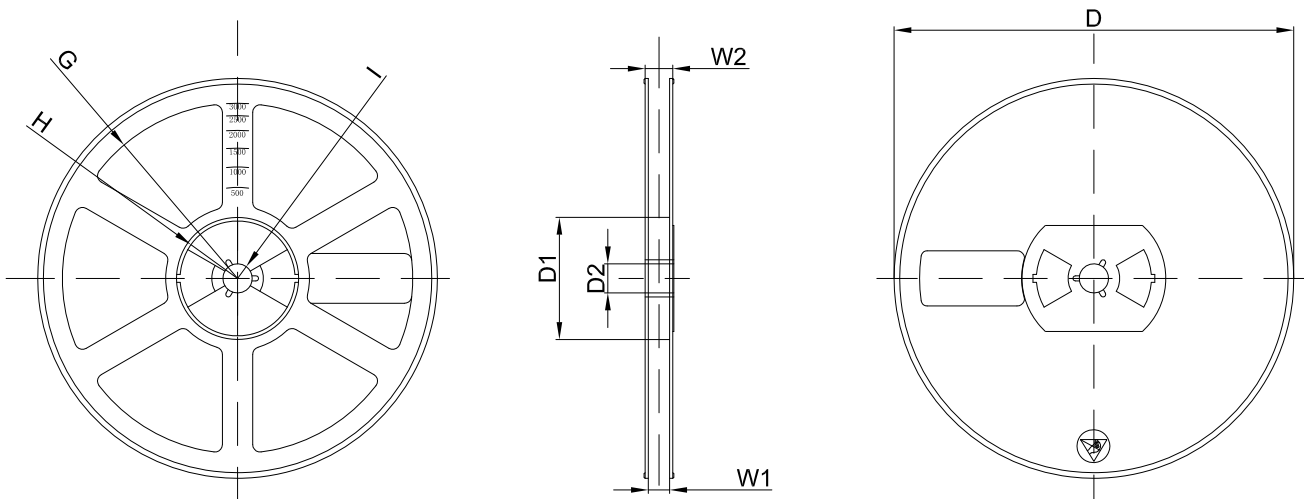

Dimensions are in millimeter								
Reel Option	D	D1	D2	G	H	I	W1	W2
7" Dia	Ø180.00	60.00	13.00	R78.00	R25.60	R6.50	9.50	13.10

REEL	Reel Size	Box	Box Size(mm)	Carton	Carton Size(mm)	G.W.(kg)
3000 pcs	7 inch	30,000 pcs	203×203×195	120,000 pcs	438×438×220	

12 Notes and Revision History

12.1 Associated Product Family and Others

To view other products of the same type or IC products of other types, click the official website of JSCJ -- <https://www.jscj-elec.com> for more details.

12.2 Notes

Electrostatic Discharge Caution



This IC may be damaged by ESD. Relevant personnel shall comply with correct installation and use specifications to avoid ESD damage to the IC. If appropriate measures are not taken to prevent ESD damage, the hazards caused by ESD include but are not limited to degradation of integrated circuit performance or complete damage of integrated circuit. For some precision integrated circuits, a very small parameter change may cause the whole device to be inconsistent with its published specifications.

12.3 Revision History

July, 2023: changed from rev - 2.1 to rev - 2.2:

- Page 1, changed section 2 from "Naming Conventions" to "Available Packages";
- Page 1, Features, available fixed output voltage changed to "from 1.2V to 5.0V";
- Page 2, Orderable Information, added the Naming Conventions;
- Page 8, Recommended Operating Conditions, removed note 4;
- Page 15, Typical Characteristics, removed the charts of the "SCP";
- Page 34, Notes, removed the notes of the thermal metric.

May, 2023: changed from rev - 2.0 to rev - 2.1:

- Added new device of CJ6330A18P into data sheet;
- Page 9, Thermal Information, added R_{JC} .

December, 2022: changed from rev - 1.1 to rev - 2.0:

- Changed the data sheet layout to JSCJ format;
- Added Pin Configuration and Marking Information, ESD Ratings, Thermal Information, Detailed Description, Application and Implementation, Package Information and Notes and Revision History section;
- Page 10, Electrical Characteristics, typical I_{Short} changed from 25mA into 75mA, typical PSRR changed from 80dB@100Hz, 45dB@100kHz into 75dB@100Hz, 40dB@100kHz.

DISCLAIMER

IMPORTANT NOTICE, PLEASE READ CAREFULLY

The information in this data sheet is intended to describe the operation and characteristics of our products. JSCJ has the right to make any modification, enhancement, improvement, correction or other changes to any content in this data sheet, including but not limited to specification parameters, circuit design and application information, without prior notice.

Any person who purchases or uses JSCJ products for design shall: 1. Select products suitable for circuit application and design; 2. Design, verify and test the rationality of circuit design; 3. Procedures to ensure that the design complies with relevant laws and regulations and the requirements of such laws and regulations. JSCJ makes no warranty or representation as to the accuracy or completeness of the information contained in this data sheet and assumes no responsibility for the application or use of any of the products described in this data sheet.

Without the written consent of JSCJ, this product shall not be used in occasions requiring high quality or high reliability, including but not limited to the following occasions: medical equipment, military facilities and aerospace. JSCJ shall not be responsible for casualties or property losses caused by abnormal use or application of this product.

Official Website: www.jscj-elec.com

Copyright © JIANGSU CHANGJING ELECTRONICS TECHNOLOGY CO., LTD.