

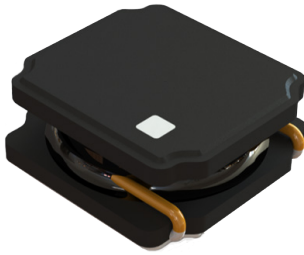





# SMT Power Inductor

Shielded Drum Core - PA4331.XXXNLT Series



-  **Height:** 1.2mm Max
-  **Footprint:** 3.2mm x 3.2mm Max
-  **Current Rating:** up to 4.2A
-  **Inductance Range:** 0.33uH to 10uH
-  **Shielded magnetic circuit reduces leakage flux, Fe base metal core enables high saturation and metalized core termination results in excellent shock resistance.**

### Electrical Specifications @ 25°C - Operating Temperature -40°C to +125°C

Part Number	Inductance 1MHz, 1V uH ±20%	Rated Current A	Min. Self-Resonant Frequency MHz	DC Resistance		Saturation Current (20°C) A	Heating Current
				MAX.	TYP.		ΔT ≈ 40°C
				mΩ	mΩ		A
PA4331.331NLT	0.33	4.20	107	27	23	7.20	4.20
PA4331.471NLT	0.47	3.90	86	33	28	6.80	3.90
PA4331.681NLT	0.68	3.40	63	42	35	5.80	3.40
PA4331.102NLT	1.0	2.70	51	54	45	4.20	2.70
PA4331.152NLT	1.5	2.50	37	74	64	3.40	2.50
PA4331.222NLT	2.2	2.05	28	108	90	2.80	2.05
PA4331.332NLT	3.3	1.70	25	155	129	2.20	1.70
PA4331.472NLT	4.7	1.30	20	235	196	2.00	1.30
PA4331.682NLT	6.8	1.10	16	340	290	1.60	1.10
PA4331.103NLT	10	1.00	12	474	395	1.20	1.00

#### Notes:

- Actual temperature of the component during system operation (ambient plus temperature rise) must be within the standard operating range.
- The rated current as listed is either the saturation current (@ 20°C) or the heating current (ΔT ≈ 40°C) depending on which value is lower.
- The saturation current is the current at which the initial inductance drops approximately 30% at the stated ambient temperature. This current is determined by placing the component in the specified ambient environment and applying a short duration pulse current (to eliminate self-heating effect) to the component.
- The heating current is the DC current required to raise the component temperature by approximately 40°C. Take note that the components' performance varies depending on the system condition. It is suggested that the component be tested at the system level, to verify the temperature rise of the component during system operation.
- Maximum voltage across terminals to be limited to <40Vdc

Mechanical

PA4331.XXXNLT

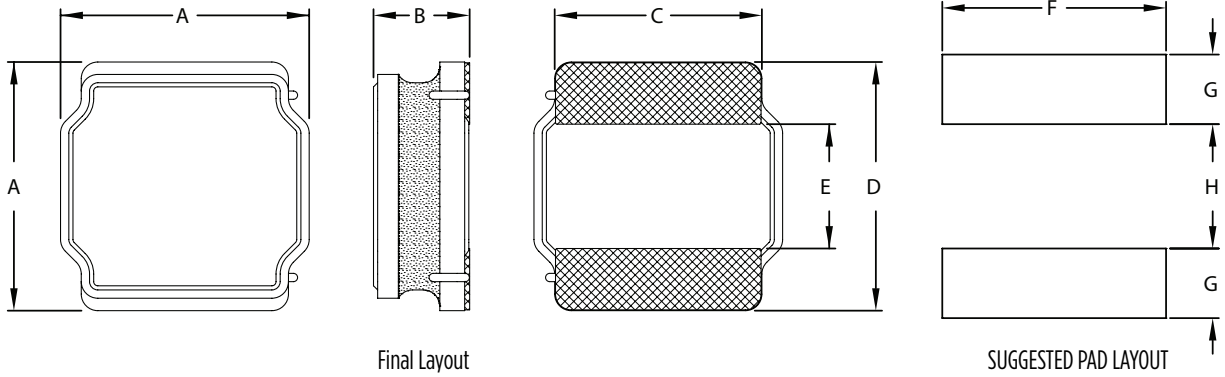

Series	A	B	C	D	E	F	G	H
PA4331.XXXNLT	3.2 MAX	1.2 MAX	(2.6)	(3.0)	(1.5)	(3.2)	(0.8)	(1.5)

All Dimensions in mm.

TAPE & REEL INFO

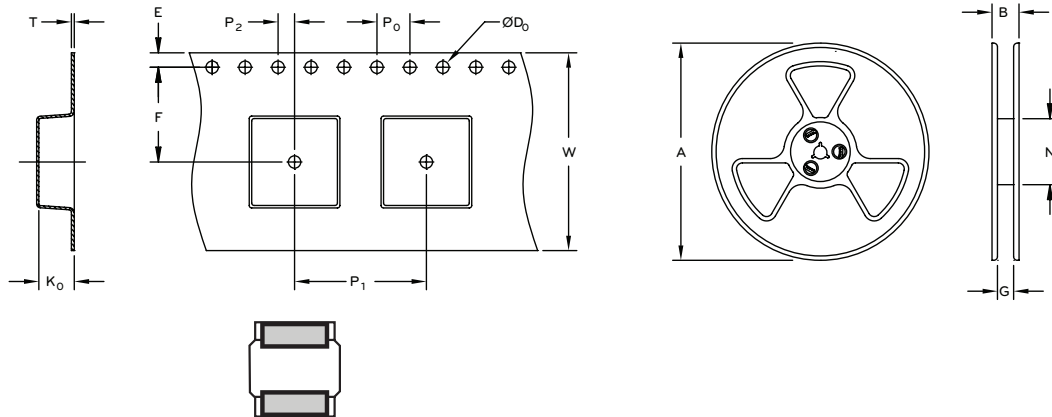

SURFACE MOUNTING TYPE, REEL/TAPE LIST

	REEL SIZE (mm)				TAPE SIZE (mm)								QTY	
	A	B	G	N	E	F	D <sub>0</sub>	P <sub>1</sub>	P <sub>0</sub>	P <sub>2</sub>	W	T	K <sub>0</sub>	PCS/REEL
PA4331.XXXNLT	Ø178	14.4	8.4	58	1.75	3.5	1.5	4	4	2	8	0.25	1.2	2000

Typical Performance Curves

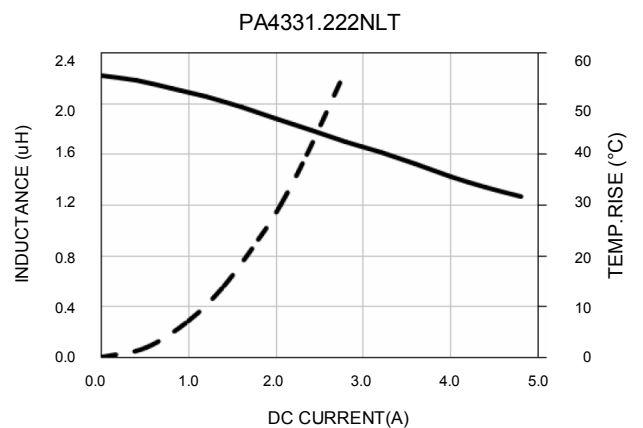
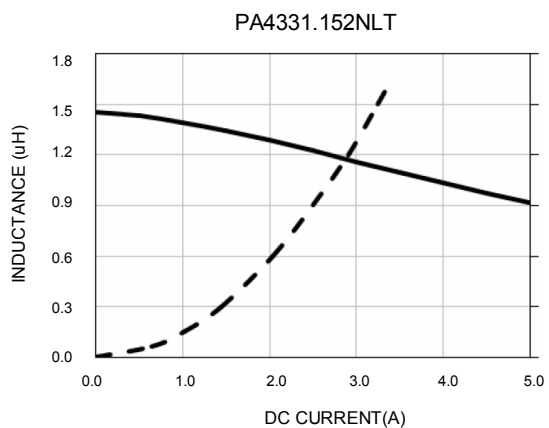
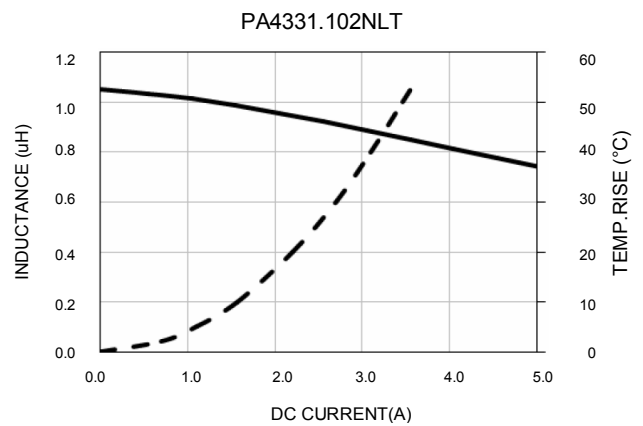
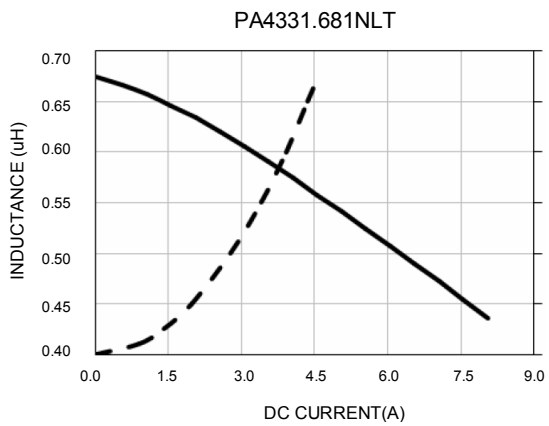
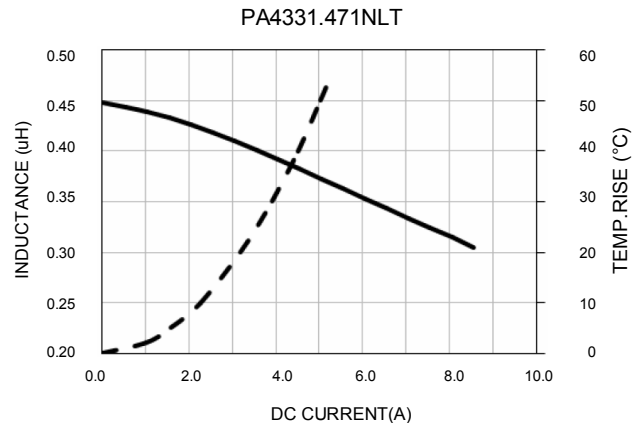
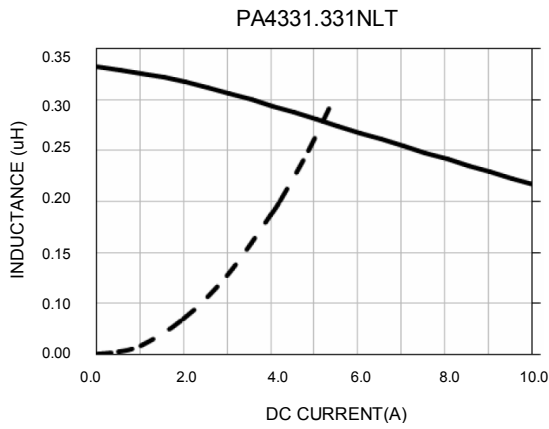

# SMT Power Inductor

Shielded Drum Core - PA4331.XXXNLT Series

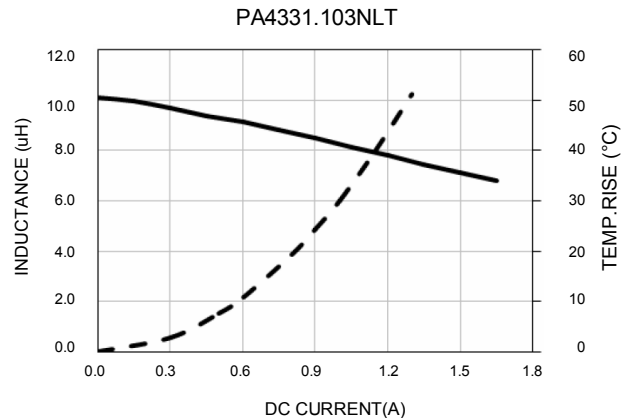
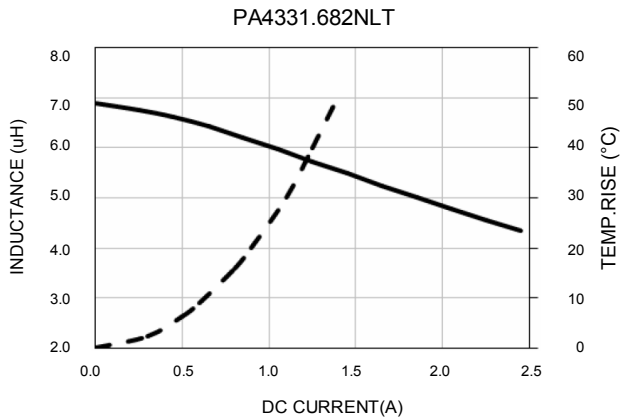
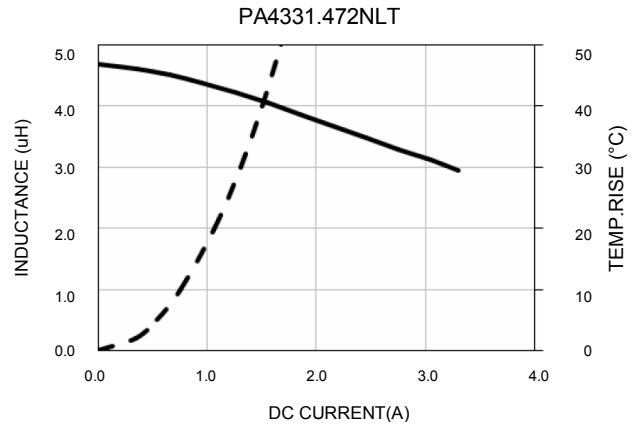
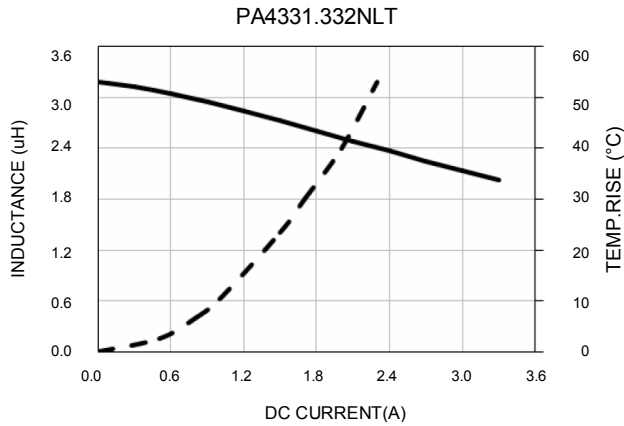

## For More Information:

Americas - [prodinfo\\_power\\_americas@yageo.com](mailto:prodinfo_power_americas@yageo.com) | Europe - [prodinfo\\_power\\_emea@yageo.com](mailto:prodinfo_power_emea@yageo.com) | Asia - [prodinfo\\_power\\_asia@yageo.com](mailto:prodinfo_power_asia@yageo.com)

Performance warranty of products offered on this data sheet is limited to the parameters specified. Data is subject to change without notice. Other brand and product names mentioned herein may be trademarks or registered trademarks of their respective owners. © Copyright, 2023. Pulse Electronics, Inc. All rights reserved.

YAGEO Corporation and its affiliates do not recommend the use of commercial or automotive grade products for high reliability applications or manned space flight.