



Terminals & Splices > Automotive Terminals > MULTILOCK, RECEPTACLE AND TAB



Terminal Type: **Tab**

Mating Tab Width: **.8 mm [.031 in]**

Mating Tab Thickness: **.4 mm [.016 in]**

Terminal Transmits: **0 – 24 A (Low Power)**

Wire Size: **22 – 20 AWG**

[All MULTILOCK, RECEPTACLE AND TAB \(110\)](#)

Features

Product Type Features

Sealable	Yes
Primary Locking Feature	Clean Body

Body Features

Terminal Seal Type	Family Seal
--------------------	-------------

Contact Features

Contact Size	.8mm
Contact Fabrication	Stamped & Formed
Wire Contact Termination Area Plating Material	Tin
Crimp Type	F-Crimp
Terminal Type	Tab
Mating Tab Width	.8 mm [.031 in]
Mating Tab Thickness	.4 mm [.016 in]
Interface Plating	Tin (Sn)

Termination Features

Termination Method to Wire & Cable	Crimp
Product Terminates To	Wire



Dimensions

Compatible Insulation Diameter Range	1.4 – 1.7 mm
Wire Size	.3 – .5 mm ²
Wire Size Search	20 AWG, 21 AWG, 22 AWG

Usage Conditions

Insulation Option	Uninsulated
Operating Temperature (Max)	80 °C, 85 °C, 90 °C, 100 °C, 105 °C[176 °F][185 °F][194 °F][212 °F][221 °F]
Operating Temperature Range	-40 – 105 °C[-40 – 221 °F]

Operation/Application

Compatible With Wire Base Material	Copper
------------------------------------	--------

Packaging Features

Packaging Quantity	12000
Packaging Method	Reel

Other

Terminal Transmits	0 – 24 A (Low Power)
--------------------	----------------------

Product Compliance

[For compliance documentation, visit the product page on TE.com>](#)

EU RoHS Directive 2011/65/EU	Compliant
EU ELV Directive 2000/53/EC	Compliant
China RoHS 2 Directive MIIT Order No 32, 2016	No Restricted Materials Above Threshold
EU REACH Regulation (EC) No. 1907/2006	Current ECHA Candidate List: JUNE 2023 (235) Candidate List Declared Against: JUNE 2023 (235) Does not contain REACH SVHC
Halogen Content	Low Halogen - Br, Cl, F, I < 900 ppm per homogenous material. Also BFR/CFR/PVC Free
Solder Process Capability	Not applicable for solder process capability

Product Compliance Disclaimer

This information is provided based on reasonable inquiry of our suppliers and represents our current actual knowledge based on the information they provided. This information is subject to change. The part numbers that TE has identified as EU RoHS compliant have a maximum concentration of 0.1% by weight in homogenous materials for lead, hexavalent chromium, mercury, PBB, PBDE, DBP, BBP, DEHP, DIBP, and 0.01% for cadmium, or qualify for an exemption to these

limits as defined in the Annexes of Directive 2011/65/EU (RoHS2). Finished electrical and electronic equipment products will be CE marked as required by Directive 2011/65/EU. Components may not be CE marked. Additionally, the part numbers that TE has identified as EU ELV compliant have a maximum concentration of 0.1% by weight in homogenous materials for lead, hexavalent chromium, and mercury, and 0.01% for cadmium, or qualify for an exemption to these limits as defined in the Annexes of Directive 2000/53/EC (ELV). Regarding the REACH Regulation, the information TE provides on SVHC in articles for this part number is based on the latest European Chemicals Agency (ECHA) 'Guidance on requirements for substances in articles' posted at this URL: <https://echa.europa.eu/guidance-documents/guidance-on-reach>

Compatible Parts



TE Part # CAT-M9194-CH8172
MULTILOCK, CONNECTOR HOUSING



TE Part # 2151132-2
OCEAN_2.0_APPLICATOR-S-050F057OA



TE Part # 1579018-4
INSERTION TOOL



TE Part # 1463405-1
SAHT MINI MULTI LOCK 22-20 ASSY



TE Part # 2151132-1
OCEAN_2.0_APPLICATOR-S-050F057O



TE Part # 2305570-1
Strip Terminal Cutter-Side Feed-No Crimp



TE Part # 7-2151132-1
OCEAN_2.0_APPLICATOR-S-050F057O



TE Part # 7-2151132-2
OCEAN_2.0_APPLICATOR-S-050F057OA



KIT
REPRESENTATION ONLY

TE Part # 7-2151132-7
OCEAN_2.0_SPARE_PART_KIT-050F057O

Also in the Series | Multilock Connector System



Automotive Connector Caps & Covers (8)

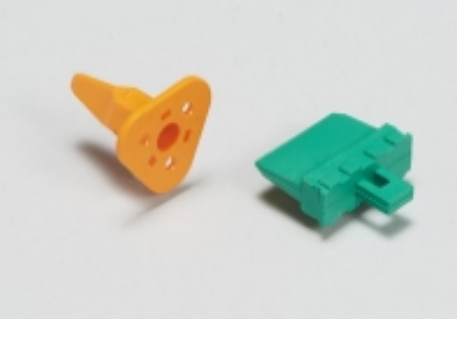

Automotive Connector Locks & Position Assurance(2)



Automotive Housings(426)

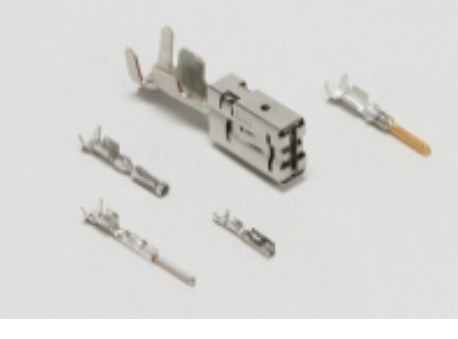

Automotive Terminals(110)

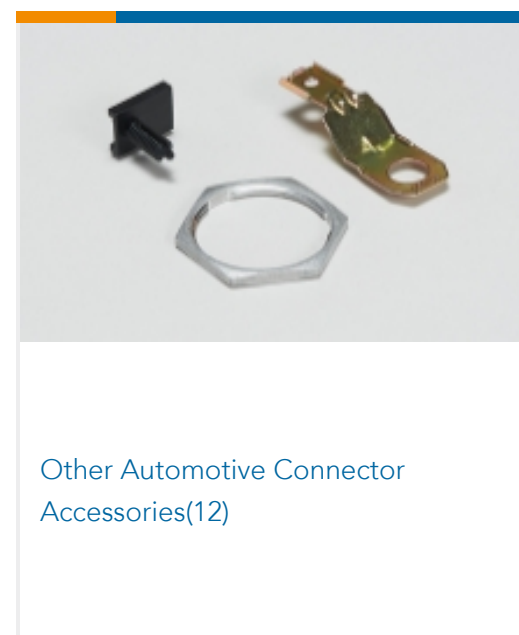
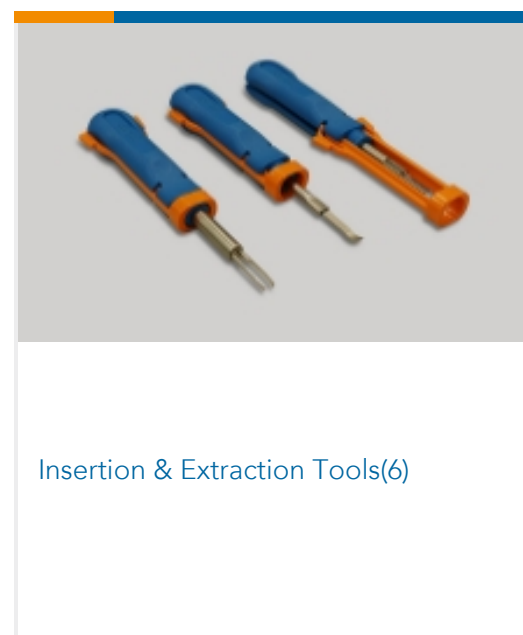
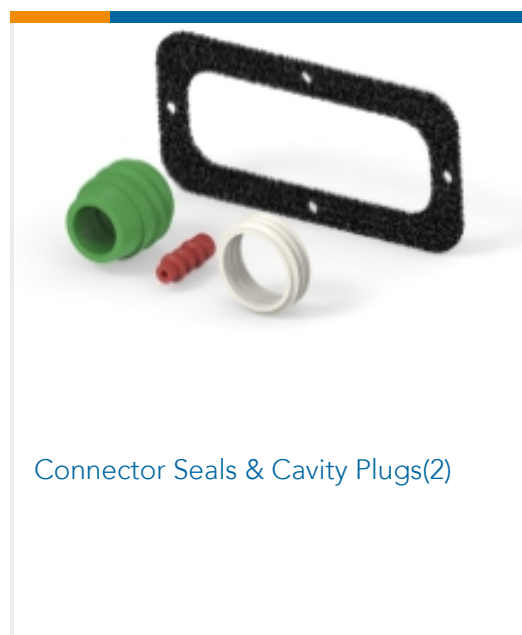

Customers Also Bought

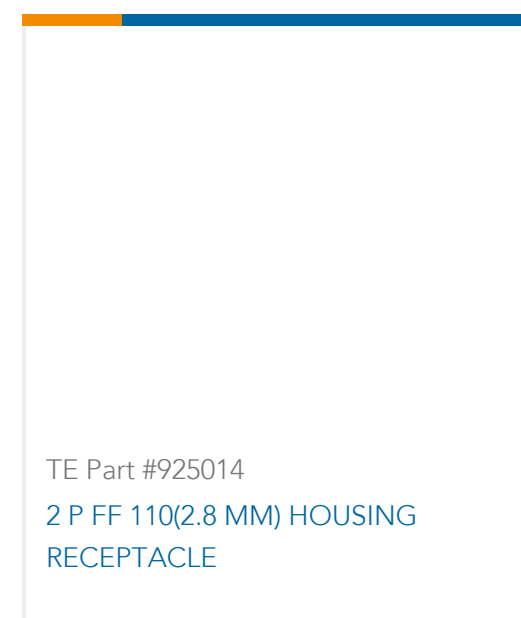
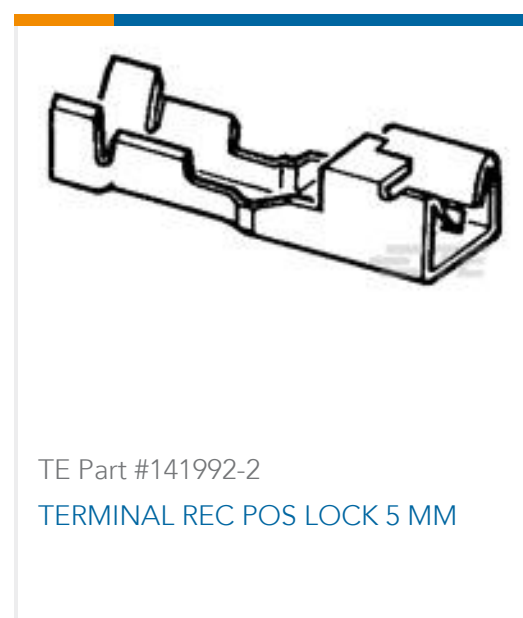

Documents

Product Drawings

MINI MLC CONN. TAB CONT.

Japanese

CAD Files

Customer View Model

[ENG_CVM_917309-1_A.3d_igs.zip](#)

English

Customer View Model

[ENG_CVM_917309-1_A.3d_stp.zip](#)

English

Customer View Model

[ENG_CVM_917309-1_A.2d_dxf.zip](#)

English

3D PDF

English

By downloading the CAD file I accept and agree to the [Terms and Conditions](#) of use.



Datasheets & Catalog Pages

MULTILOCK Connector System

English

Product Specifications

Application Specification

English

CRIMPING OF MINI-MULTI-LOCK CONNECTOR CONTACTS

English

Instruction Sheets

Mini Multilock Connector

English