

光继电器
Photo Relay
ATV252
Product Data Sheet

AOTE DCC
RELEASE

台湾奥特半导体科技有限公司

TAIWAN AOTE SEMICONDUCTOR TECHNOLOGY CO.,LTD

www.aotesemi.com

概述 Description

ATV252光继电器由红外发光二极管和光电发生器、MOSFET耦合组成。 ATV252实现低导通电阻。

The ATV252 PhotoRelay consist of a photo MOSFET、Photovoltage generator、infrared LED. The ATV252 achieves low on-resistance.

特性 Features

- . 控制 60V 交流或直流电压
Control 60V AC or DC voltage
- . 开关 3.5A 负载
Switch 3.5A load
- . 工作温度：-40°C ~ +85°C
Operating Temperature: -40°C ~ +85°C
- . 低关断漏电流
Low off state leakage current
- . 低导通电阻
Low on-resistance
- . 输入-输出隔离电压 ($V_{ISO} = 5000 V_{rms}$)
High isolation voltage between input and output($V_{ISO} = 5000 V_{rms}$)
- . 符合加强绝缘标准
Meet reinforced insulation standards
- . 无铅，符合 RoHS 标准
Lead free, meet RoHS standards

应用 Applications

- . 工业机械及设备
Industrial machinery and Equipment
- . 防盗、防灾市场
Anti-theft, Aisaster prevention market
- . 空调控制
Air conditioning control
- . 娱乐市场
Entertainment market

封装和原理图 Package and Schematic Diagram

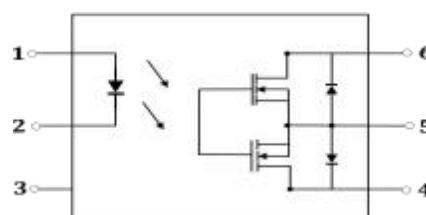

Pin Configuration

1. AN
2. CA
3. N/CO
4. D1
5. Source
6. D2



产品型号命名规则 Order Code

AT V252 - UN Y - W (V) (ZZ)

① ② ③ ④ ⑤ ⑥ ⑦

- ① 公司代码 Company Code (AT: 奥特 AOTE)
- ② 产品系列 Product Series (V252: V252)
- ③ 框架类型 Lead Frame (Cu: 铜框架 Copper)
- ④ 树脂类型 Epoxy Type (H: 无卤 Halogen-free, L: 有卤/无铅 Halogen/Lead-free)
- ⑤ 封装形式 Package (D: DIP , S: SMD)
- ⑥ 器件工作温度范围 Device Operating Temperature Range (特殊范围需填或者空白 Special Range need to be filled in or left blank)
- ⑦ 内部补充代码 Internal Supplementary Code (数字或者空白 Number or None)

印字信息 Marking Information

- . 印字中  为奥特品牌 LOGO
- . "" denotes LOGO
- . 印字中 "Y" 代表年份 : A(2018),B(2019),C(2020).....
"Y" denotes YEAR : A(2018), B(2019), C(2020).....
- . 印字中 "WW" 代表周号
"WW" denotes Week' s number.
- . 印字中 "N" 代表星期几
"N" denotes the day of the week.
- . 印字中的 "H" 代表无卤 : 而当产品有卤/无铅时 , 此处空白
"H" denotes Halogen-free, when the product has halogen/lead-free, leave this blank.



绝缘和安规信息 Insulation and Safety related specifications

项目 Item	符号 Symbol	数值 Value	单位 Unit	备注 Remark
爬电距离 Creepage Distance	L	7.0	mm	从输入端到输出端，沿本体最短距离路径 Measured from input terminals to output terminals, shortest distance path along body.
电气间隙 Clearance Distance	L	7.0	mm	从输入端到输出端，通过空气的最短距离 Measured from input terminals to output terminals, shortest distance through air.
绝缘距离 Insulation Thickness	DTI	0.4	mm	发射器和探测器之间的绝缘厚度 Insulation thickness between emitter and detector.
峰值隔离电压 Peak Isolation Voltage	V_{IORM}	1500	V_{peak}	DIN/EN/IEC EN60747-5-5.
瞬态隔离电压 Transient isolation voltage	V_{IOTM}	7000	V_{peak}	DIN/EN/IEC EN60747-5-5.
隔离电压 Isolation Voltage	V_{ISO}	5000	V_{rms}	For 1 minute.

极限参数 Absolute Maximum Ratings ($T_A = 25^\circ\text{C}$)

参数 Parameter		符号 Symbol	额定值 Rating	单位 Unit	
发射端 Input	LED 正向电流 LED Forward Current	I_F	50	mA	
	LED 反向电压 LED Reverse Voltage	V_R	5	V	
	峰值正向电流 Peak Forward Current	I_{FP}	1	A	
	输入功率 Power Dissipation	P_{in}	75	mW	
接收端 Output	负载电压(AC 峰值) Load Voltage (Peak AC)	V_L	60	V	
	持续负载电流 Continuous Load Current	I_L	A	3.5	A
			B	5	
			C	7	
峰值负载电流 Peak Load Current	I_{peak}	10	A		
输出功率 Power Dissipation	P_{out}	600	mW		
总功耗 Total Power Dissipation	P_{tot}	650	mW		
输入输出瞬态耐受电压 Isolation Voltage	V_{ISO}	5000	V_{rms}		
工作温度 Operating Temperature	T_{opr}	-40 ~ +85	$^\circ\text{C}$		
存储温度 Storage Temperature	T_{stg}	-40 ~ +100	$^\circ\text{C}$		
焊接温度 Soldering Temperature	T_{sol}	260	$^\circ\text{C}$		

注意: A 连接方式:峰值交流、直流; B, C 连接方式: 直流;
 Note: A connection: Peak AC, DC; B, C connection: DC.

产品特性参数 Electro-optical Characteristics ($T_A = 25^\circ\text{C}$)

参数 Parameter		符号 Symbol	条件 Condition	最小 Min.	典型 Typ.	最大 Max.	单位 Unit
发射端 Input	LED 开启电流 LED Operate Current	I_{on}	$I_L = 100\text{mA}$	-	0.5	3	mA
	LED 关断电流 LED Turn Off Current	I_{off}	$I_L = 100\text{mA}$	0.2	0.4	-	mA
	LED 正向压降 LED Dropout Voltage	V_F	$I_F = 5\text{mA}$	-	1.3	1.5	V
接收端 Output	导通电阻 On Resistance	A	$I_F = 5 \text{ mA}$ $I_L = \text{MAX}$ Within 1s on time	-	0.052	0.06	Ω
		B		-	0.028	0.04	Ω
		C		-	0.016	0.02	Ω
	关断漏电 Off State Leakage Current	I_{leak}	$I_F = 0 \text{ mA}$ $V_L = \text{MAX}$	-	-	1	μA
传输特性 Transfer Characteristics	开启时间 Turn On Time	T_{on}	$I_F = 5 \text{ mA}$ $V_L = 10\text{V}$ $I_L = 100\text{mA}$	-	2.5	5	ms
	关断时间 Turn Off Time	T_{off}	$I_F = 5 \text{ mA}$ $V_L = 10\text{V}$ $I_L = 100\text{mA}$	-	0.15	0.5	ms
	I/O 电容 I/O Capacitance	C_{ISO}	$f = 1 \text{ MHz}$ $V_B = 0\text{V}$	-	0.8	1.5	pF
	初始 I/O 隔离电阻 Initial I/O Isolation Resistance	R_{ISO}	500 V DC	1000	-	-	M Ω

典型光电特性曲线 Typical Electro-Optical Characteristics Curves

Fig.1 LED Dropout Voltage vs. Ambient Temperature

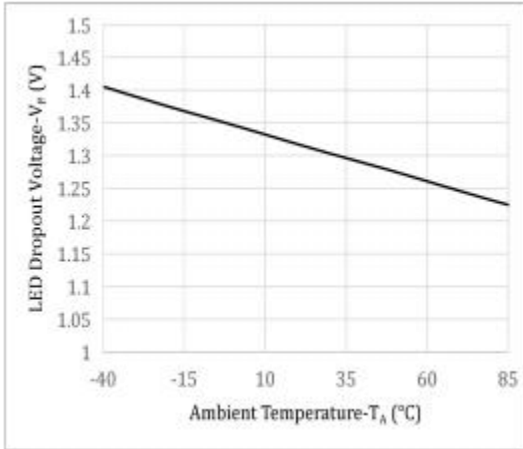

Fig.2 Output Current vs. Output Voltage

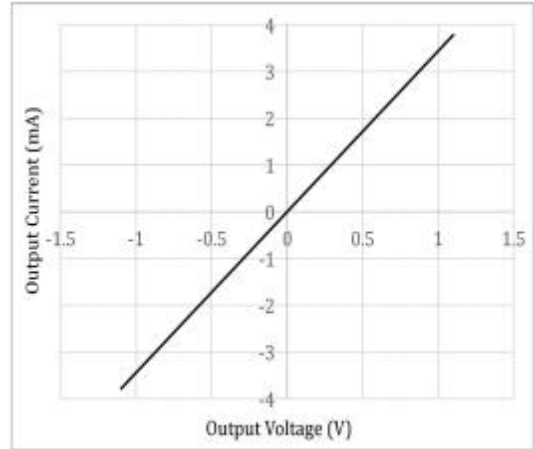

Fig.3 On Resistance vs. Ambient Temperature

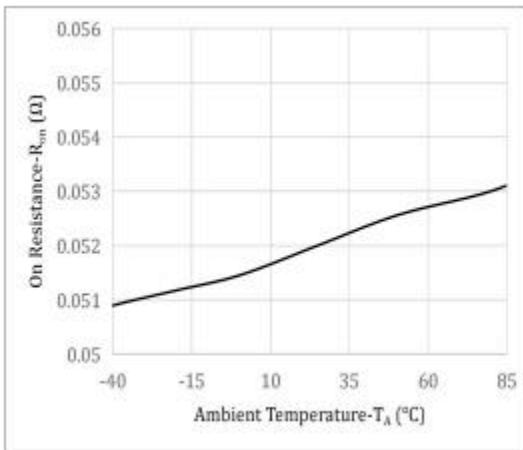

Fig.4 Load Current vs. Ambient Temperature

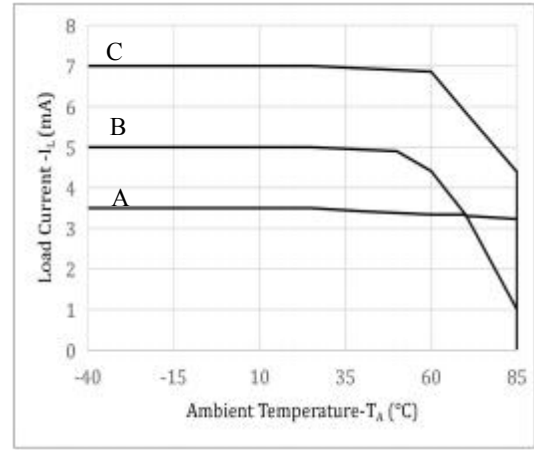

Fig.5 LED Operate Current vs. Ambient Temperature

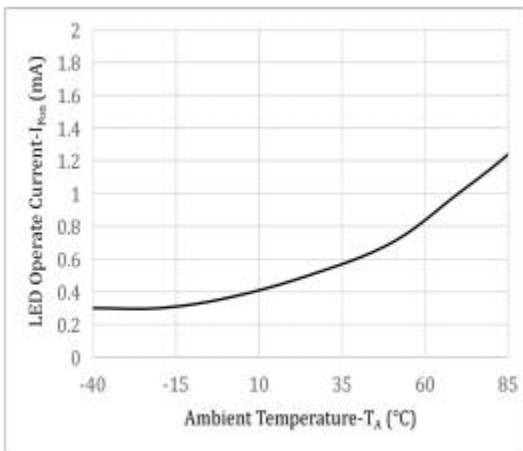

Fig.6 LED Turn Off Current vs. Ambient Temperature

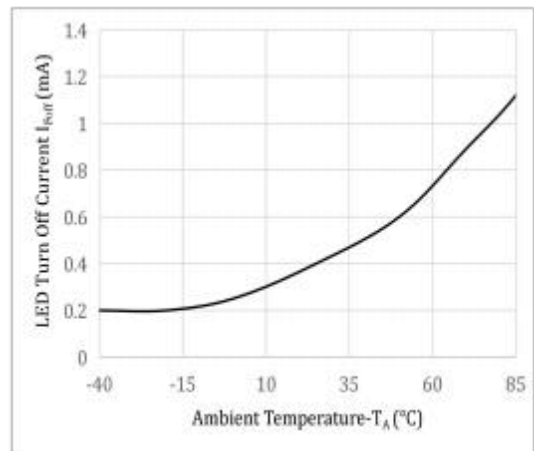

Fig.7 Turn On Time vs. Ambient Temperature

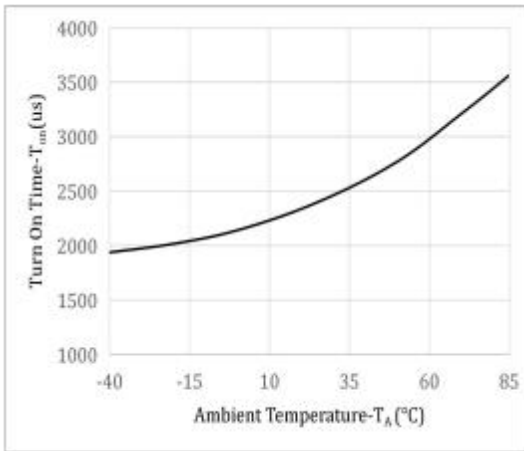

Fig.8 Turn Off Time vs. Ambient Temperature

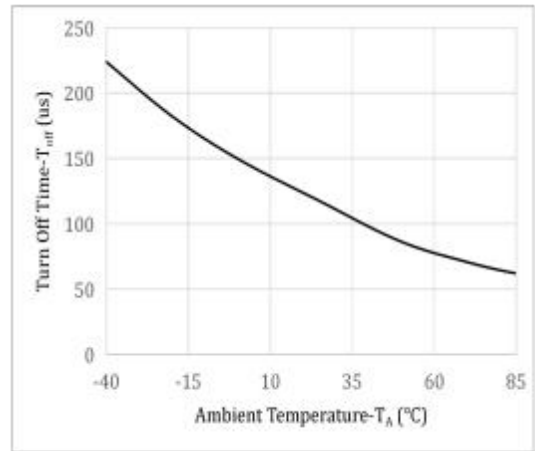

Fig.9 Turn On Time vs. LED Forward Current

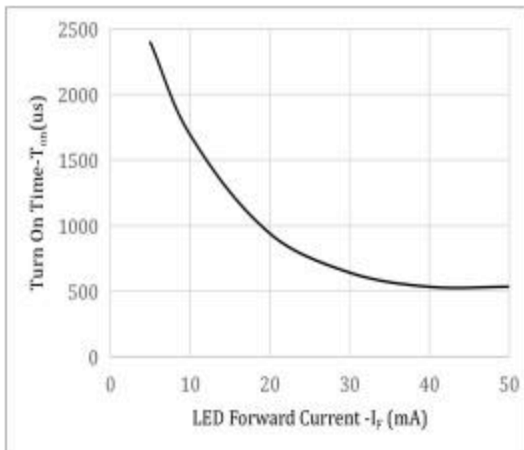

Fig.10 Turn Off Time vs. LED Forward Current

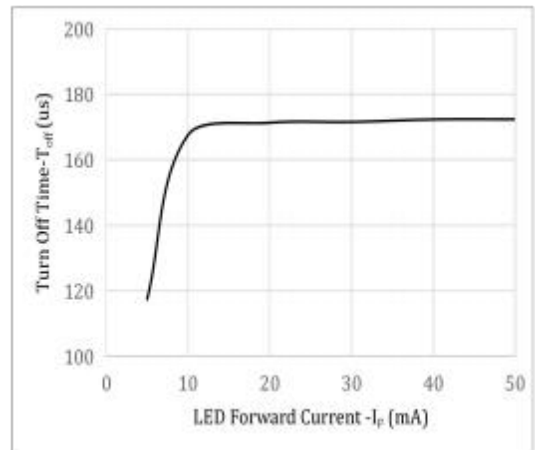
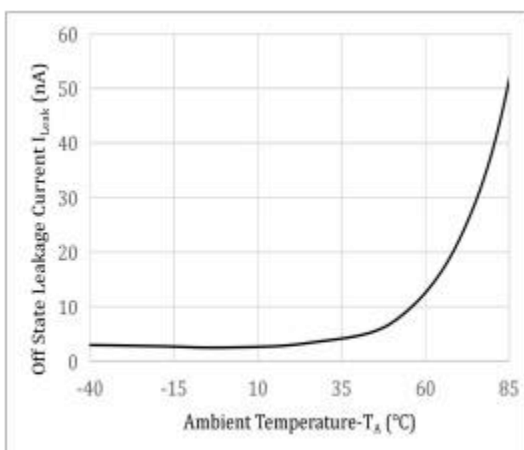
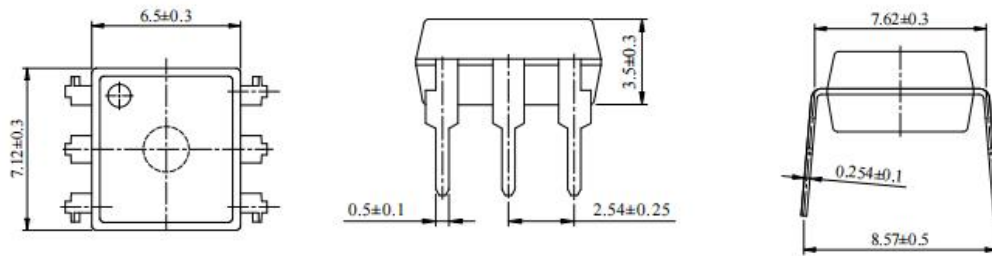

Fig.11 Off State Leakage Current vs. Ambient Temperature



外形尺寸 Outline Dimensions

DIP6



SMD6

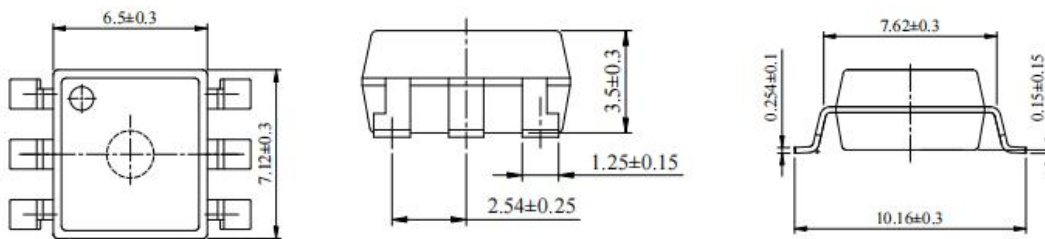

建议焊盘布局 Recommended Pad Layout

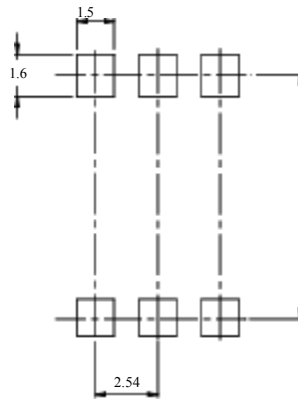

单位 Unit: mm

注：上图为产品正视图。
Note: The picture above is the front view of the product.

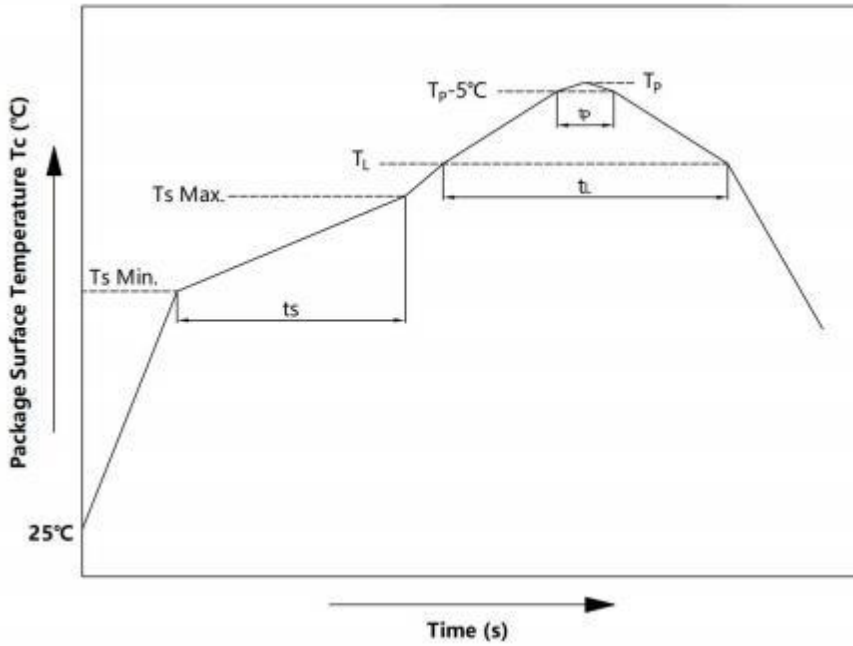
回流焊温度曲线图 Solder Reflow Profile

项目 Item	符号 Symbol	最小值 Min.	最大值 Max	单位 Unit
预热温度 Preheat Temperature	T_s	150	200	$^\circ\text{C}$
预热时间 Preheat Time	t_s	60	120	s
升温速率 Ramp-Up Rate (T_L to T_P)	-	-	3	$^\circ\text{C}/\text{s}$
液相线温度 Liquidus Temperature	T_L	217		$^\circ\text{C}$
时间高于 T_L Time Above T_L	t_L	60	150	s
峰值温度 Peak Temperature	T_P	-	260	$^\circ\text{C}$
T_c 在 $(T_P - 5)$ 和 T_P 之间的时间 Time During Which T_c Is Between $(T_P - 5)$ and T_P	t_p	-	30	s
降温速率 Ramp-down Rate (T_P to T_L)	-	-	6	$^\circ\text{C}/\text{s}$

注：建议在所示的温度和时间条件下进行回流焊，最多不能超过三次。

Note: Reflow soldering is recommended at the temperatures and times shown, no more than three times.

波峰焊温度曲线图 Wave Soldering Profile

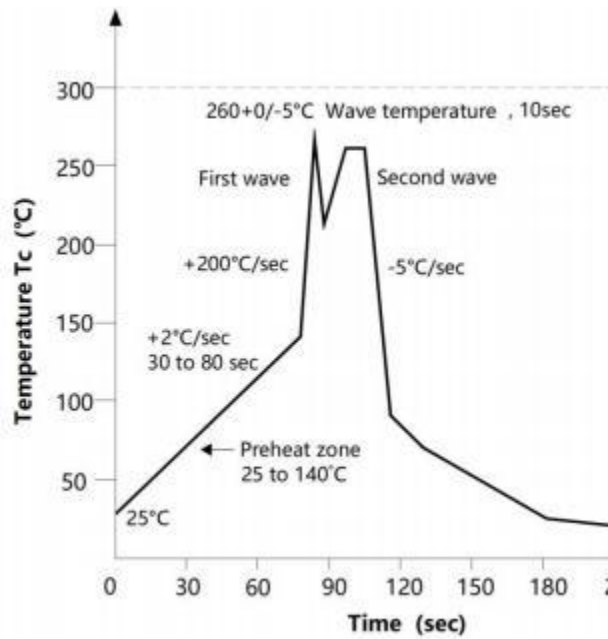

手工烙铁焊接 Soldering with hand soldering iron

- A. 手工烙铁焊仅用于产品返修或样品测试；
Hand soldering iron is only used for product rework or sample testing;
- B. 手工烙铁焊要求：温度 $360^{\circ}\text{C} \pm 5^{\circ}\text{C}$ ，时间 $\leq 3\text{s}$ 。
Manual soldering method Temperature: $360^{\circ}\text{C} \pm 5^{\circ}\text{C}$, within 3s.

包装 Packing

■ 汇总表 Summary table

封装形式	包装方式	盘数量	盒数量	箱数量	静电袋	盒规格	箱(双瓦楞)规格	备注
SMD6	卷盘 (ϕ 330mm 蓝盘)	1千只/盘	2盘/盒	10盒/箱	450*390*0.1mm	340*60*340 mm	620*360*365mm	首尾端空至少 200mm
DIP6	管装 (500*12*11mm)	65只/管	50管/盒	10盒/箱	不适用	525*128*56 mm	535*275*300 mm	每管使用蓝白胶塞, 方向须一致
Package Type	Packing Form	Quantity per Reel	Quantity per Box	Quantity per Carton	Antistatic Bag Specification	Box Specification	Carton Specification	Note
SMD6	Reel (ϕ 330mm Blue)	1k pcs/reel	2 reels /box	10 boxes /ctn	380*380mm	340*60*340 mm	620*360*365mm	Leave at least 200mm of blank space at both ends
DIP6	Tube (500*12*11mm)	65 pcs/tube	50 tubes/box	10 boxes/ctn	Not applicable	525*128*56 mm	535*275*300mm	Use blue and white rubber stoppers for each tube, with the same direction

■ SMD6 编带包装 Tape & Reel

- 每卷数量：2000 只。
Qty/reel：2000 pcs.
- 每箱数量：40000 只。
Qty/ctn：40000 pcs.
- 内包装：每盒 2 盘。
Inner packing：2 reels/box.
- 示意图 Schematic：

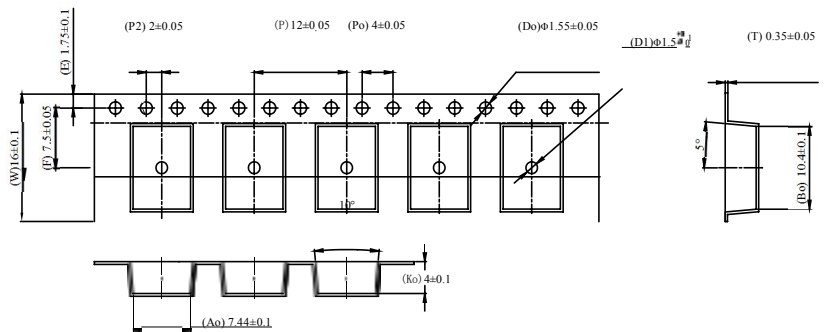

■ DIP6 条管包装 Tube

- 每条管数量：65 只。
Qty/tube：65 pcs.
- 每箱数量：32500 只。
Qty/ctn：32500 pcs.
- 内包装：每盒 50 管。
Inner packing：50 tubes/box.
- 示意图 Schematic：

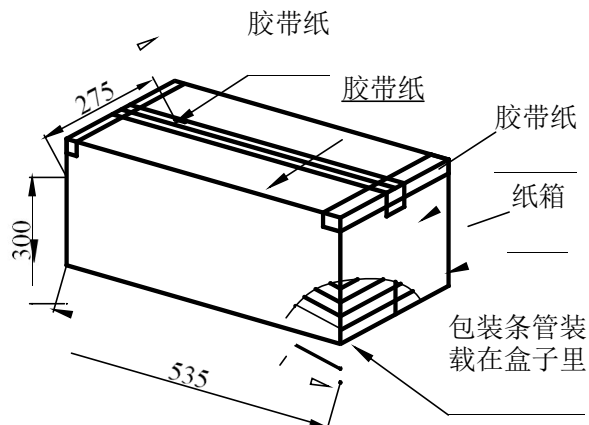

单位 Unit：mm

注意 Attention

- 奥特持续不断改进质量、可靠性、功能或设计，保留此文件更改的权利恕不另行通知。
AOTE continuously improve quality, reliability, function or design. We reserve the right to change this document without notice.
- 请遵守产品规格书使用，奥特不对使用时不符合产品规格书条件而导致的质量问题负责。
Please use in accordance with the product specification. AOTE is not responsible for the quality problems caused by non-compliance with the product specifications.
- 对于需要高可靠性或安全性的设备/装置需求，请联系我们的销售人员。
For equipment/devices where high reliability or safety is required, please contact our sales representatives.
- 当需要用于任何“特定”应用时，请咨询我们的销售人员。
When requiring a device for any “specific” application, please contact our sales in advice.
- 如对文件中表述的内容有疑问，欢迎联系我们。
If you have any questions about the contents of the document, please contact us.