

## HDSP-740x Series, HDSP-750x Series, HDSP-780x Series, HDSP-A15x Series, HDSP-A40x Series

### 7.6 mm (0.3 inch) Micro Bright Seven-Segment Displays

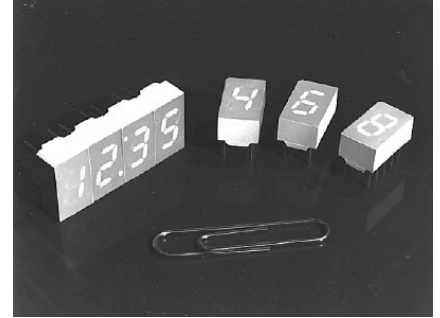

#### Description

The Broadcom<sup>®</sup> 7.6 mm (0.3 inch) LED seven-segment displays are designed for viewing distances up to 3 meters (10 feet). These devices use an industry-standard size package and pinout. Both the numeric and  $\pm 1$  overflow devices feature a right-hand decimal point. All devices are available as either common anode or common cathode.

These displays are ideal for most applications. Pin-for-pin equivalent displays are also available in a low-current design. The low-current displays are ideal for portable applications. For additional information, refer to the *Low Current Seven-Segment Displays* (document number: AV02-2554EN).

#### Features

- Compact package
  - 0.300 x 0.500 inches
  - Leads on 2.54 mm (0.1 inch) centers
- Choice of colors: AllnGaP Deep Red, AllnGaP Red, AllnGaP Yellow, AllnGaP Green, and GaP Orange
- Excellent appearance
  - Evenly lighted segments
  - Mitered corners on segments
  - Surface color gives optimum contrast
  - $\pm 50^\circ$  viewing angle
- Design flexibility
  - Common anode or common cathode
  - Right-hand decimal point
  - $\pm 1$  right-hand decimal overflow character
- Categorized for luminous intensity
  - Yellow and Green categorized for color
  - Use of like categories yields a uniform display

# Package Drawing

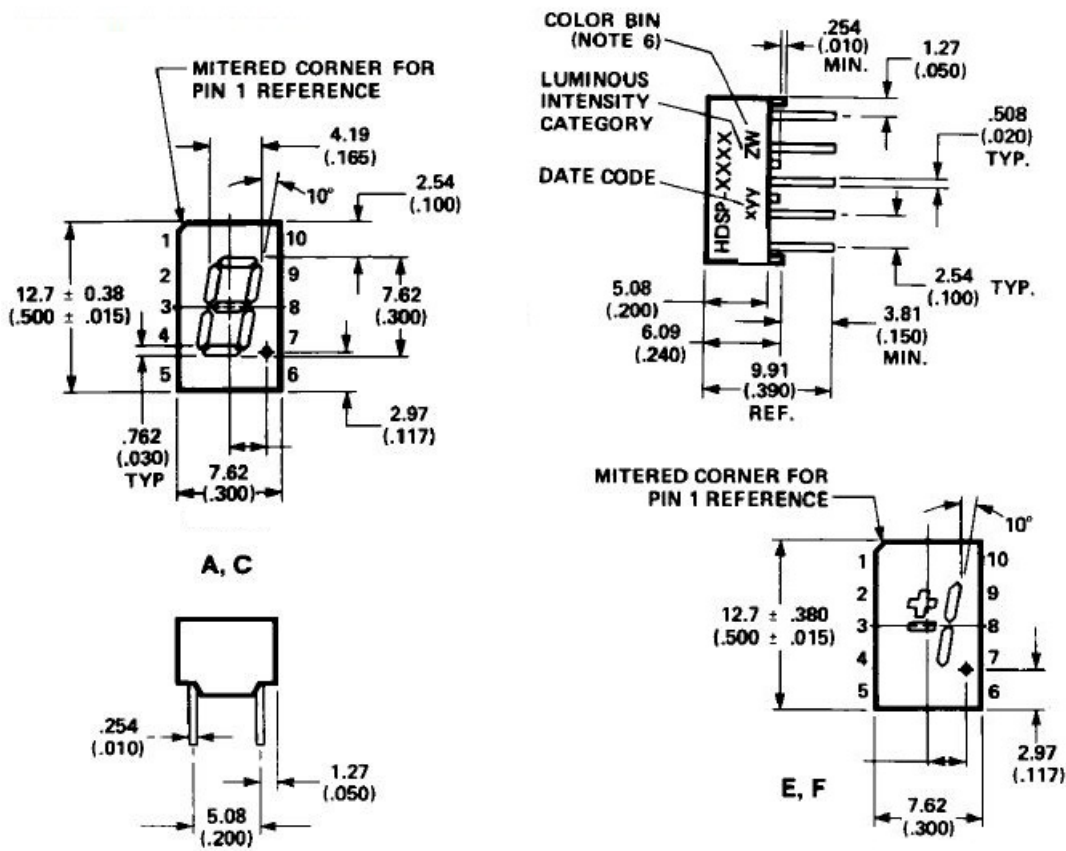

**NOTE:** All dimensions are in millimeters (inches). All untoleranced dimensions are for reference only.

## Internal Circuit Diagram

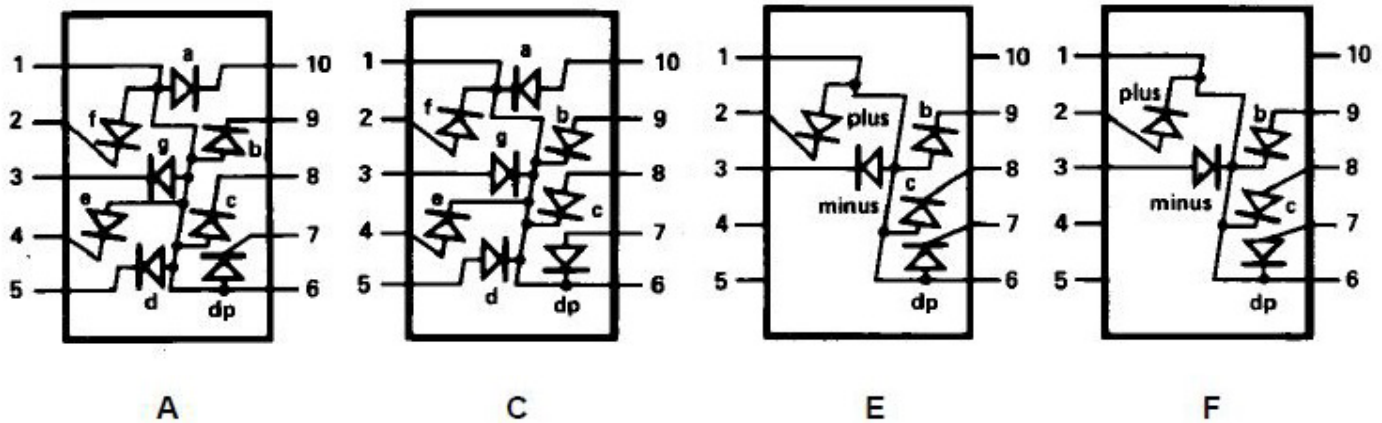

Pin	Function			
	A	C	E	F
1	ANODE <sup>a</sup>	CATHODE <sup>b</sup>	ANODE <sup>a</sup>	CATHODE <sup>c</sup>
2	CATHODE f	ANODE f	CATHODE PLUS	ANODE PLUS
3	CATHODE g	ANODE g	CATHODE MINUS	ANODE MINUS
4	CATHODE e	ANODE e	NC	NC
5	CATHODE d	ANODE d	NC	NC
6	ANODE <sup>a</sup>	CATHODE <sup>b</sup>	ANODE <sup>a</sup>	CATHODE <sup>b</sup>
7	CATHODE DP	CATHODE DP	CATHODE DP	ANODE DP
8	CATHODE c	CATHODE c	CATHODE c	ANODE c
9	CATHODE b	CATHODE b	CATHODE b	ANODE b
10	CATHODE a	CATHODE a	NC	NC

- a. Redundant anodes.
- b. Redundant cathodes.
- c. For the HDSP-7400/7800 series product only.

## Device Selection Guide

GaP Orange	AllnGaP Deep Red	AllnGaP Red	AllnGaP Yellow	AllnGaP Green	Description	Package Drawing
HDSP-A401	HDSP-A151	HDSP-7501	HDSP-7401	HDSP-7801	Common anode right-hand decimal	A
HDSP-A403	HDSP-A153	HDSP-7503	HDSP-7403	HDSP-7803	Common cathode right-hand decimal	C
—	—	HDSP-7507	—	HDSP-7807	Common anode $\pm 1$ right-hand decimal overflow	E
—	—	HDSP-7508	—	HDSP-7808	Common cathode $\pm 1$ right-hand decimal overflow	F

## Absolute Maximum Ratings

Description	Deep Red HDSP-A150 Series	Red/Orange/ HDSP-7500/ HDSP-A40X Series	Yellow HDSP-7400 Series	Green HDSP-7800 Series	Unit
Power Dissipation per Segment or DP	100	75	50	75	mW
Peak Forward Current per Segment or DP <sup>a</sup>	90	90	60	90	mA
DC Forward Current per Segment or DP <sup>b</sup>	40	30	20	30	mA
Operating Temperature Range	-20 to +100	-40 to +100			°C
Storage Temperature Range	-55 to +100				°C
Reverse Voltage per Segment or DP <sup>c</sup>	3.0				V
Wave Soldering Temperature for 3 Seconds (1.59 mm [0.063 in.] below Body)	250				°C

a. Duty factor = 10%, frequency = 1 kHz, T<sub>A</sub> = 25°C.

b. Derate linearly as shown in [Figure 4](#) (Deep Red), [Figure 8](#) (Red), [Figure 12](#) (Orange), [Figure 16](#) (Yellow), and [Figure 20](#) (Green).

c. Reverse voltage is for LED testing purposes and is not recommended to be used as an application condition.

## Electrical/Optical Characteristics (T<sub>A</sub> = 25°C)

Parameter	Symbol	Min.	Typ.	Max.	Unit	Test Conditions
<b>Deep Red, Device Series HDSP-A15x</b>						
Luminous Intensity/Segment <sup>a, b</sup> (Digit Average)	I <sub>V</sub>	6.9	21	—	mcd	I <sub>F</sub> = 20 mA
Forward Voltage/Segment or DP <sup>c</sup>	V <sub>F</sub>	—	2.1	2.5	V	I <sub>F</sub> = 20 mA
Peak Wavelength	λ <sub>p</sub>	—	656	—	nm	—
Dominant Wavelength <sup>d</sup>	λ <sub>d</sub>	—	639	—	nm	—
Reverse Voltage/Segment or DP <sup>e</sup>	V <sub>R</sub>	3.0	—	—	V	I <sub>R</sub> = 100 μA
<b>Red, Device Series HDSP-750x</b>						
Luminous Intensity/Segment <sup>a, b</sup> (Digit Average)	I <sub>V</sub>	0.77	4.50	—	mcd	I <sub>F</sub> = 5 mA
Forward Voltage/Segment or DP <sup>c</sup>	V <sub>F</sub>	—	2.05	2.5	V	I <sub>F</sub> = 20 mA
Peak Wavelength	λ <sub>p</sub>	—	631	—	nm	—
Dominant Wavelength <sup>d</sup>	λ <sub>d</sub>	—	622	—	nm	—
Reverse Voltage/Segment or DP <sup>e</sup>	V <sub>R</sub>	3.0	—	—	V	I <sub>R</sub> = 100 μA
<b>Orange, Device Series HDSP-A40x</b>						
Luminous Intensity/Segment <sup>a, b</sup> (Digit Average)	I <sub>V</sub>	—	0.70	—	mcd	I <sub>F</sub> = 5 mA
Forward Voltage/Segment or DP <sup>c</sup>	V <sub>F</sub>	—	2.0	2.5	V	I <sub>F</sub> = 20 mA
Peak Wavelength	λ <sub>p</sub>	—	600	—	nm	—
Dominant Wavelength <sup>d</sup>	λ <sub>d</sub>	—	603	—	nm	—
Reverse Voltage/Segment or DP <sup>e</sup>	V <sub>R</sub>	3.0	30	—	V	I <sub>R</sub> = 100 μA

Parameter	Symbol	Min.	Typ.	Max.	Unit	Test Conditions
<b>Yellow, Device Series HDSP-740x</b>						
Luminous Intensity/Segment <sup>a, b</sup> (Digit Average)	$I_V$	0.225	2.20	—	mcd	$I_F = 5 \text{ mA}$
Forward Voltage/Segment or DP <sup>c</sup>	$V_F$	—	2.0	2.5	V	$I_F = 20 \text{ mA}$
Peak Wavelength	$\lambda_p$	—	591	—	nm	—
Dominant Wavelength <sup>d</sup>	$\lambda_d$	581.5	588	592.5	nm	—
Reverse Voltage/Segment or DP <sup>e</sup>	$V_R$	3.0	—	—	V	$I_R = 100 \mu\text{A}$
<b>Green, Device Series HDSP-780x</b>						
Luminous Intensity/Segment <sup>a, b</sup> (Digit Average)	$I_V$	1.94	7.50	—	mcd	$I_F = 10 \text{ mA}$
Forward Voltage/Segment or DP <sup>c</sup>	$V_F$	—	2.1	2.5	V	$I_F = 20 \text{ mA}$
Peak Wavelength	$\lambda_p$	—	572	—	nm	—
Dominant Wavelength <sup>d</sup>	$\lambda_d$	—	571	577	nm	—
Reverse Voltage/Segment or DP <sup>e</sup>	$V_R$	3.0	—	—	V	$I_R = 100 \mu\text{A}$

- The luminous intensity,  $I_V$ , is measured at the mechanical axis of the package.
- The optical axis is closely aligned with the mechanical axis of the package.
- The forward voltage tolerance is  $\pm 0.1\text{V}$ .
- The dominant wavelength,  $\lambda_d$ , is derived from the CIE Chromaticity Diagram and represents the perceived color of the device.
- The typical specification is for reference only. Do not exceed absolute maximum ratings, and long-term reverse bias is not recommended.

## Part Numbering System

5082 - X XX X - X X X XX  
HDSP - X XX X - X X X XX

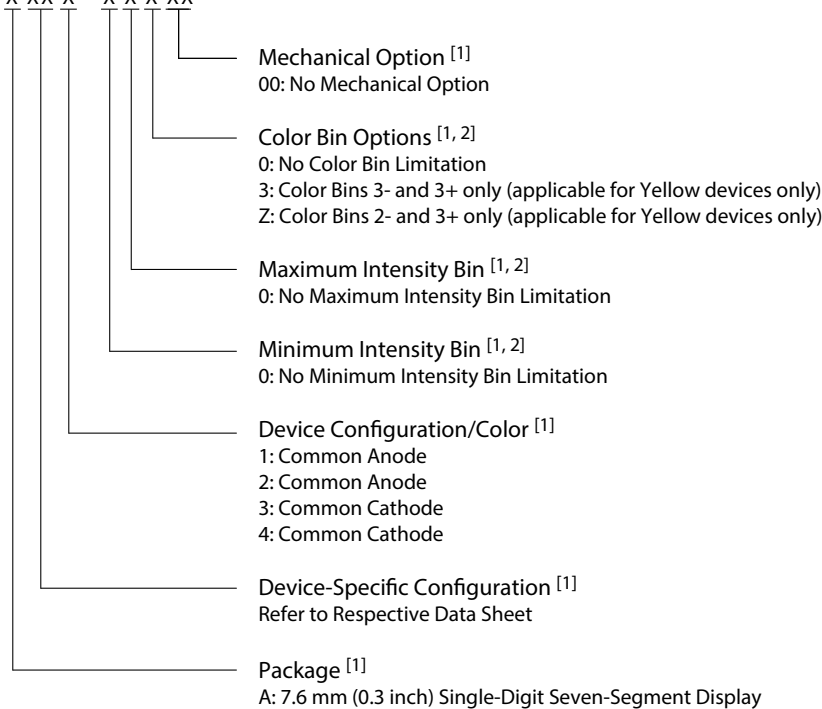

- For codes not listed in the figure above, please refer to the respective data sheet or contact your nearest Broadcom representative for details.
- Bin options refer to shippable bins for a part number. Color and Intensity Bins are typically restricted to 1 bin per tube (exceptions may apply). Refer to the respective data sheet for specific bin limit information.

# Intensity Bin Limits (mcd)

**Table 1: Deep Red: HDSP-A15x**

IV Bin Category	Min.	Max.
M	7.07	13.00
N	10.60	19.40
O	15.90	29.20
P	23.90	43.80
Q	35.80	65.60

**Table 2: Red: HDSP-750x**

IV Bin Category	Min.	Max.
D	0.774	1.418
E	1.160	2.127
F	1.740	3.190
G	2.610	4.785
H	3.915	7.177
I	5.873	10.758
J	8.802	16.118

**Table 3: Orange: HDSP-A40x**

IV Bin Category	Min.	Max.
A	0.284	0.433
B	0.354	0.541
C	0.443	0.677
D	0.554	0.846
E	0.692	1.057
F	0.856	1.322
G	1.082	1.652
H	1.352	2.066
I	1.692	2.581
J	2.114	3.227
K	2.641	4.034
L	3.300	5.042
M	4.127	6.303
N	5.157	7.878

**Table 4: Yellow: HDSP-740x**

IV Bin Category	Min.	Max.
B	0.229	0.387
C	0.317	0.582
D	0.476	0.872
E	0.714	1.311
F	1.073	1.967
G	1.609	2.950
H	2.413	4.425
I	3.621	6.639
J	5.432	9.958

**Table 5: Green: HDSP-780x**

IV Bin Category	Min.	Max.
I	1.29	2.37
J	1.94	3.55
K	2.90	5.33
L	4.37	8.01
M	6.55	12.01
N	9.83	18.02
O	14.74	27.03

**Table 6: Color Categories**

Color	Bin	Dominant Wavelength (nm)	
		Min.	Max.
Yellow	1	581.50	585.00
	3	584.00	587.50
	2	586.50	590.00
	4	589.00	592.50
Green	2	573.00	577.00
	3	570.00	574.00
	4	567.00	571.00
	5	564.00	568.00

**NOTE:** All categories are established for classification of products. Products may not be available in all categories. Please contact your Broadcom representatives for further clarification/information.

# Deep Red Graphs

Figure 1: Relative Intensity vs. Wavelength

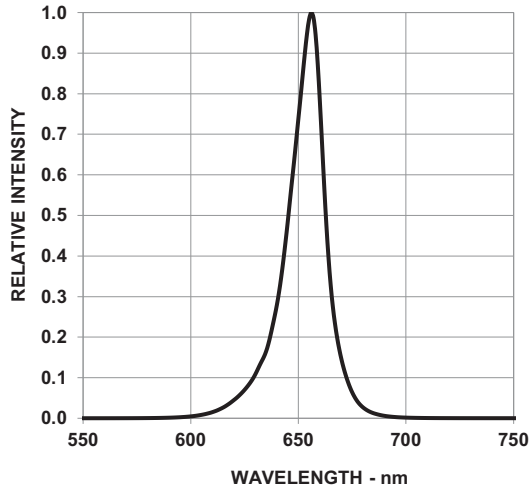

Figure 2: Forward Current vs. Forward Voltage

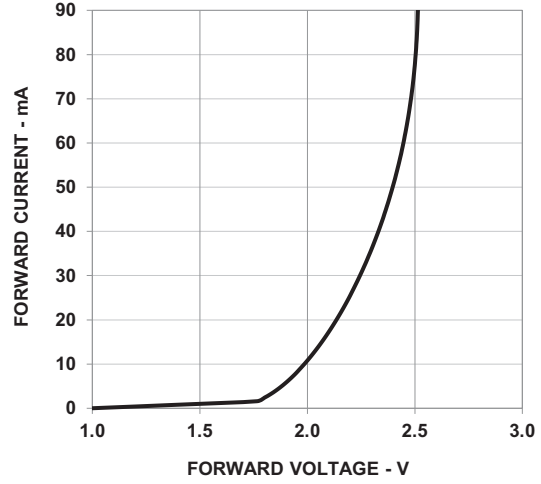

Figure 3: Relative Luminous Intensity vs. Forward Current

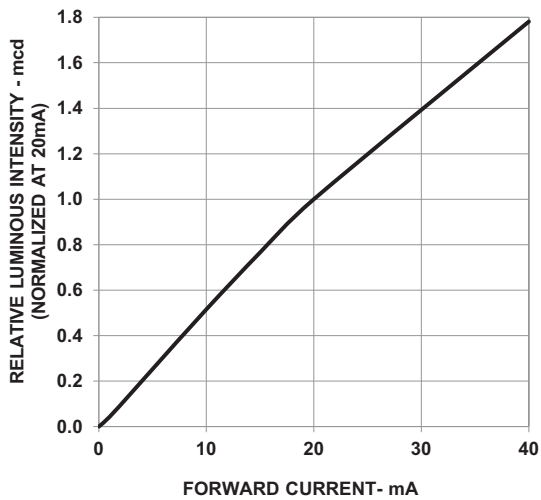
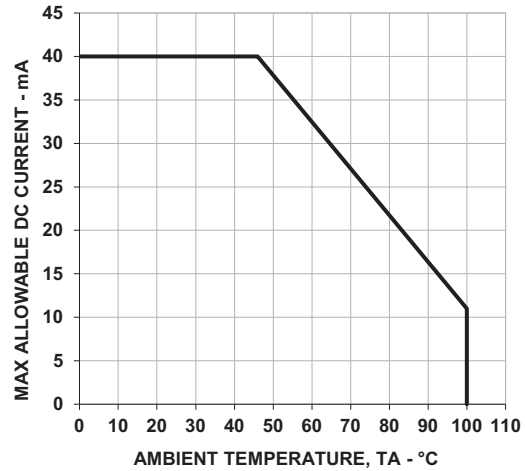

Figure 4: Maximum Forward Current vs. Ambient Temperature



# Red Graphs

Figure 5: Relative Intensity vs. Wavelength

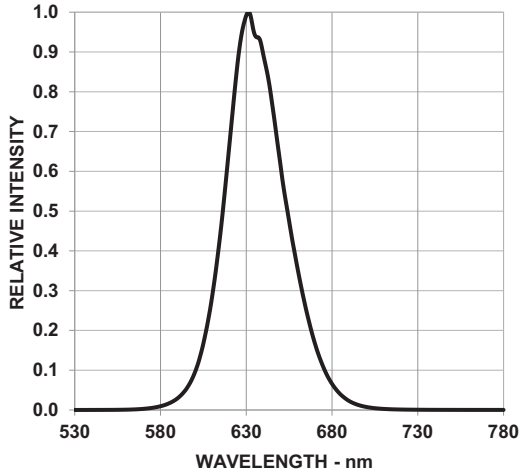

Figure 6: Forward Current vs. Forward Voltage

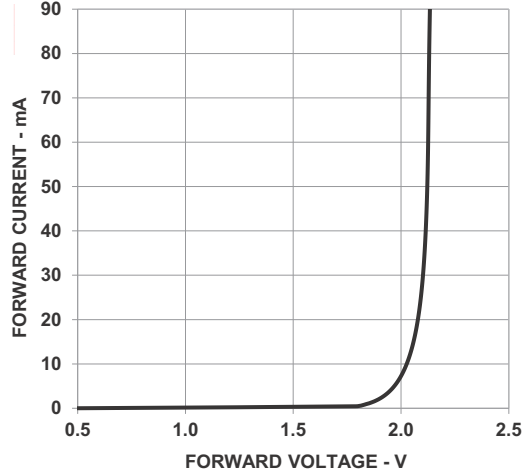

Figure 7: Relative Luminous Intensity vs. Forward Current

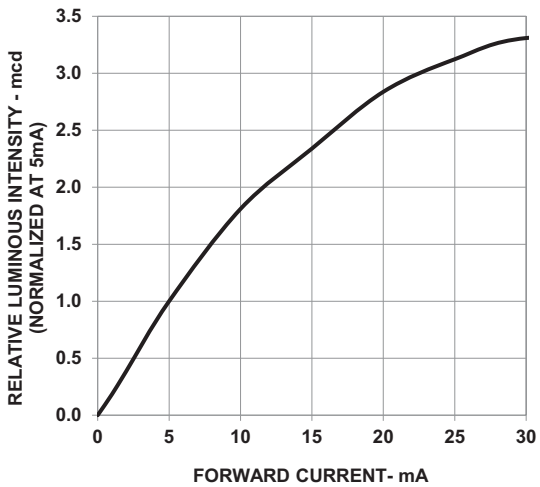
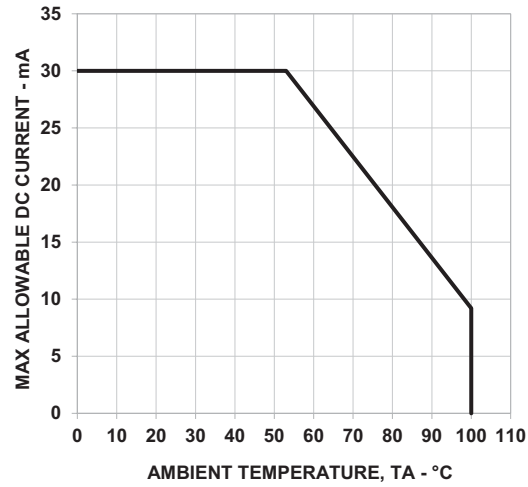

Figure 8: Maximum Forward Current vs. Ambient Temperature





# Orange Graphs

Figure 9: Relative Intensity vs. Wavelength

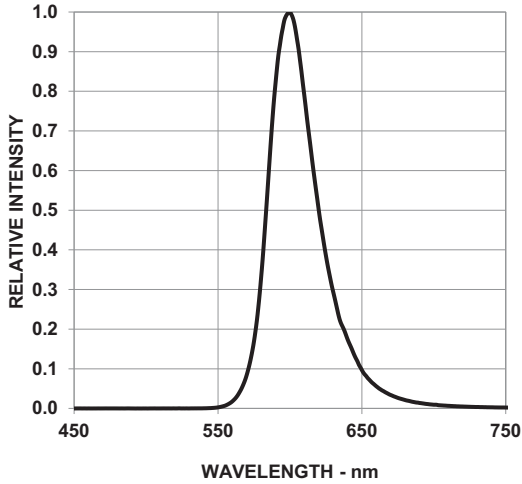

Figure 10: Forward Current vs. Forward Voltage

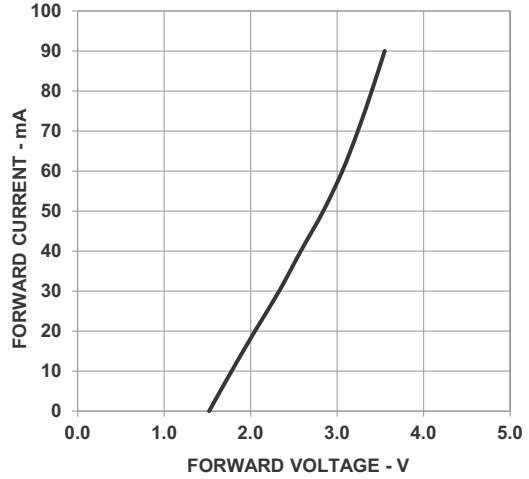

Figure 11: Relative Luminous Intensity vs. Forward Current

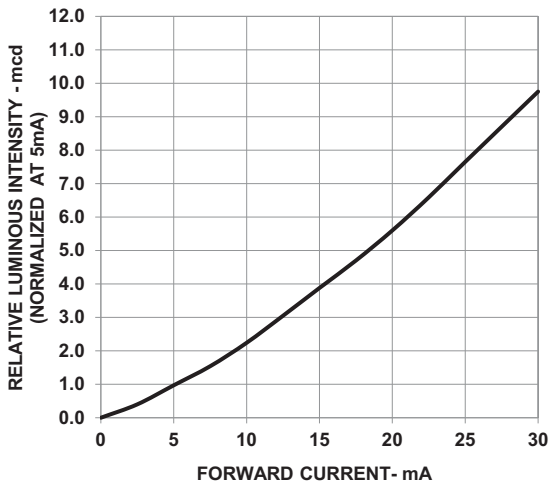
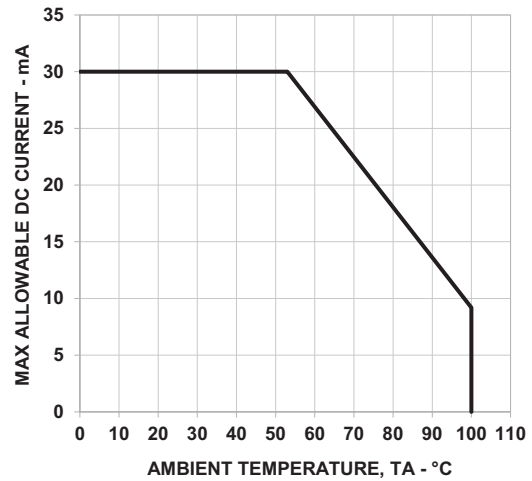

Figure 12: Maximum Forward Current vs. Ambient Temperature



# Yellow Graphs

Figure 13: Relative Intensity vs. Wavelength

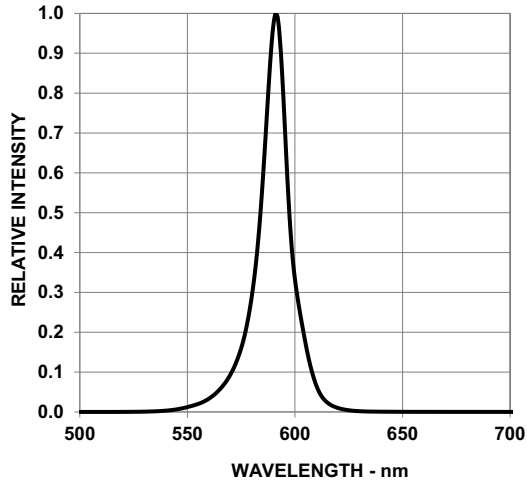

Figure 14: Forward Current vs. Forward Voltage

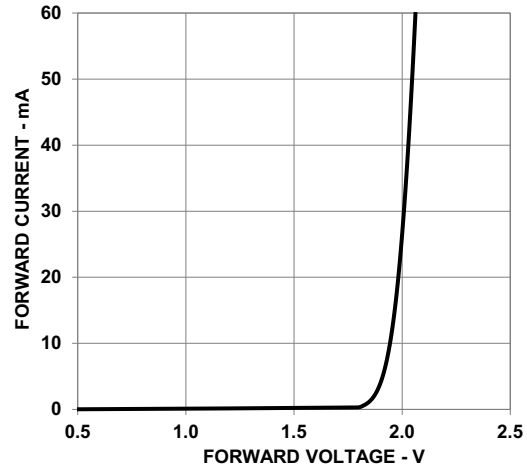

Figure 15: Relative Luminous Intensity vs. Forward Current

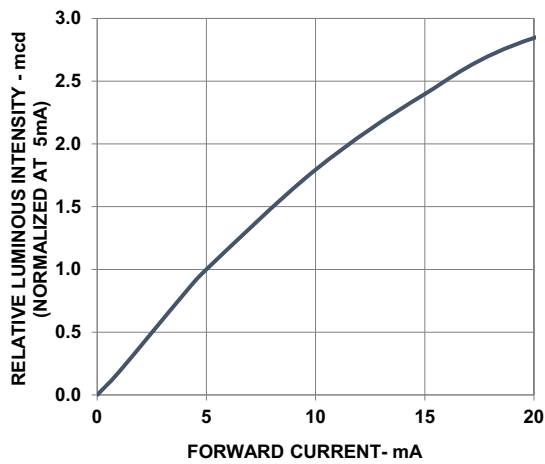
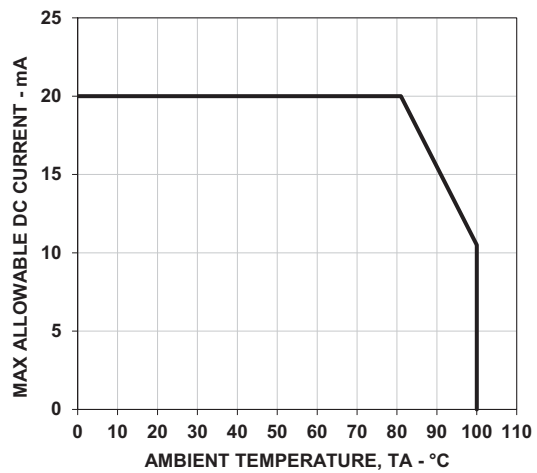

Figure 16: Maximum Forward Current vs. Ambient Temperature



# Green Graphs

Figure 17: Relative Intensity vs. Wavelength

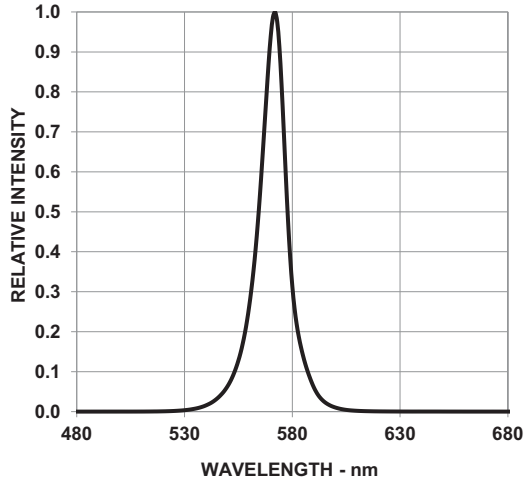

Figure 18: Forward Current vs. Forward Voltage

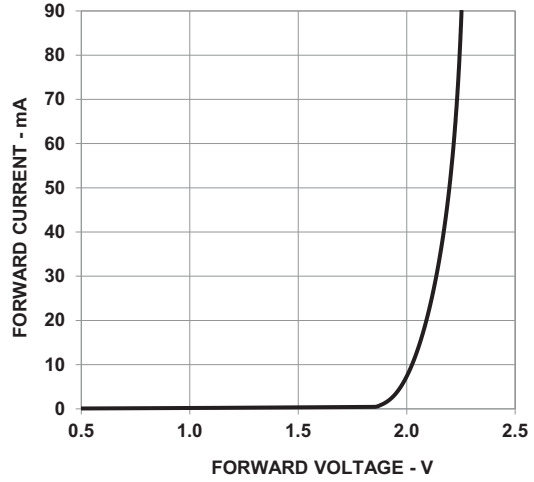

Figure 19: Relative Luminous Intensity vs. Forward Current

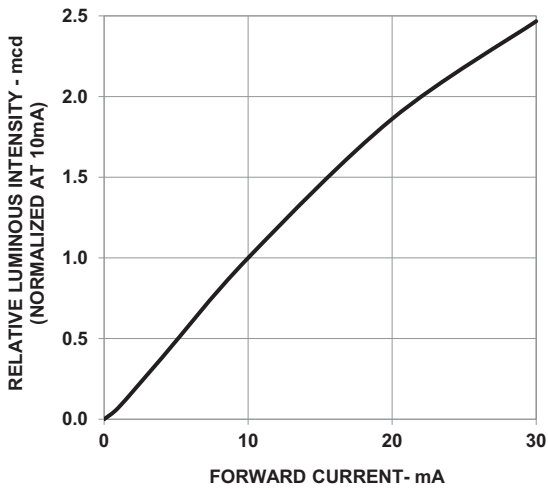
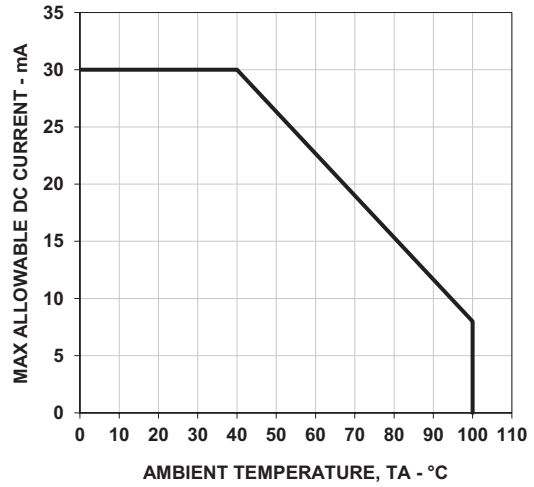

Figure 20: Maximum Forward Current vs. Ambient Temperature



## Precautionary Notes

### Soldering and Handling Precautions

- Set and maintain the wave soldering parameters according to the recommended temperature and dwell time. Perform daily checks on the profile to ensure that it is always conforming to the recommended conditions. Exceeding these conditions will over-stress the LEDs and cause premature failures.
- Use only bottom preheaters to reduce thermal stress experienced by the LEDs.
- Recalibrate the soldering profile before loading a new type of a PCB. PCBs with different sizes and designs (component density) will have different heat capacities and might cause a change in temperature experienced by the PCB if the same wave soldering setting is used.
- Do not perform wave soldering more than once.
- Any alignment fixture used during wave soldering must be loosely fitted and must not apply stress on the LEDs. Use non-metal material because it will absorb less heat during the wave soldering process.
- At elevated temperatures, the LEDs are more susceptible to mechanical stress. Allow the PCB to be sufficiently cooled to room temperature before handling. Do not apply stress to the LED when it is hot.
- Use wave soldering to solder the LED. Use hand soldering only for rework or touch up if unavoidable, but it must be strictly controlled to following conditions:
  - Soldering iron tip temperature = 315°C maximum.
  - Soldering duration = 2 seconds maximum.
  - Number of cycles = 1 only.
  - Power of soldering iron = 50W maximum.
- For ESD-sensitive devices, apply proper ESD precautions at the soldering station. Use only an ESD-safe soldering iron.
- Do not touch the LED package body with the soldering iron except for the soldering terminals because it may cause damage to the LED.
- Confirm beforehand whether the functionality and performance of the LED is affected by soldering with hand soldering.
- Keep the heat source at least 1.6 mm away from the LED body during soldering.
- Design an appropriate hole size to avoid problems during insertion.
- Cleaning agents from the ketone family (acetone, methyl ethylketone, and so on) and from the chlorinated hydrocarbon family (methylene chloride,

trichloroethylene, carbon tetrachloride, and so on) are not recommended for cleaning the LED displays. All of these various solvents attack or dissolve the encapsulating epoxies used to form the package of plastic LED parts.

- For the purpose of cleaning, wash with DI water only. The cleaning process should take place at room temperature only. Clear any water or moisture from the LED display immediately after washing.
- Use of *No clean* solder paste is recommended for soldering.

**Figure 21: Recommended Wave Soldering Profile**

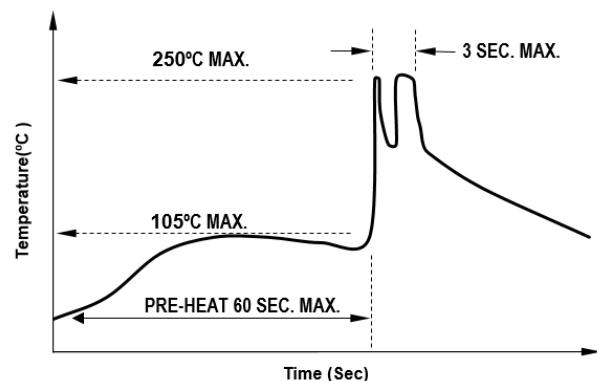

**NOTE:** Figure 21 refers to measurements with thermocouple mounted at the bottom of the PCB.

### Application Precautions

- The drive current of the LED must not exceed the maximum allowable limit across temperatures as stated in the data sheet. Constant current driving is recommended to ensure consistent performance.
- Circuit design must cater to the whole range of forward voltage ( $V_F$ ) of the LEDs to ensure the intended drive current can always be achieved.
- The LED exhibits slightly different characteristics at different drive currents, which may result in a larger variation of performance (such as intensity, wavelength, and forward voltage). Set the application current as close as possible to the test current to minimize these variations.
- The LED is not intended for reverse bias. Use other appropriate components for such purposes. When driving the LED in matrix form, ensure that the reverse bias voltage does not exceed the allowable limit of the LED.

- Avoid rapid change in ambient temperatures, especially in high-humidity environments, because they cause condensation on the LED.
- If the LED is intended to be used in a harsh or outdoor environment, protect the LED against damages caused by rain, water, dust, oil, corrosive gases, external mechanical stresses, and so on.

## Eye Safety Precautions

LEDs may pose optical hazards when in operation. Do not look directly at operating LEDs because it might be harmful to the eyes. For safety reasons, use appropriate shielding or personal protective equipment.

## Disclaimer

Broadcom products and software are not specifically designed, manufactured, or authorized for sale as parts, components, or assemblies for the planning, construction, maintenance, or direct operation of a nuclear facility or for use in medical devices or applications. The customer is solely responsible, and waives all rights to make claims against Broadcom or its suppliers, for all loss, damage, expense, or liability in connection with such use.

Copyright © 2005–2022 Broadcom. All Rights Reserved. The term “Broadcom” refers to Broadcom Inc. and/or its subsidiaries. For more information, go to [www.broadcom.com](http://www.broadcom.com). All trademarks, trade names, service marks, and logos referenced herein belong to their respective companies.

Broadcom reserves the right to make changes without further notice to any products or data herein to improve reliability, function, or design. Information furnished by Broadcom is believed to be accurate and reliable. However, Broadcom does not assume any liability arising out of the application or use of this information, nor the application or use of any product or circuit described herein, neither does it convey any license under its patent rights nor the rights of others.



Lead (Pb) Free  
RoHS Compliant