

**MOLDING POWER INDUCTORS****1. Features**

- High rated current
- Frequency up to 3 MHz
- 125°C maximum total temperature operation
- Low core loss
- Ultra low buzz noise due to molding construction
- Halogen Free & ROHS compliant

**2. Applications**

- Laptops and PCs
- Switch and servers
- Base stations
- DC/DC converters
- Battery powered devices
- SSD modules

**3. Product Identification**

$\frac{XR}{①}$      $\frac{XXXX}{②}$     ---  $\frac{XXX}{③}$      $\frac{M}{④}$

- ① Series name
- ② Dimensions and shape (0412~1265)
- ③ Inductance Value
- ④ Inductance Tolerance (M= ± 20%)

## 4. Dimensions (unit:mm)

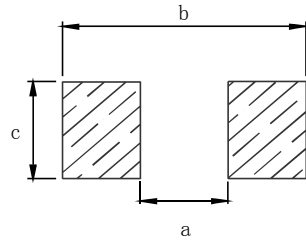
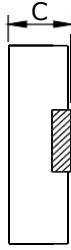
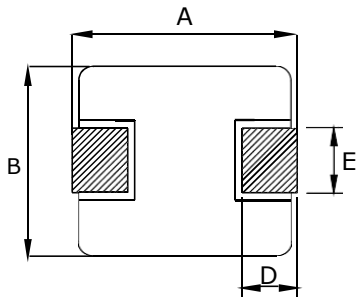

Recommend Land Pattern

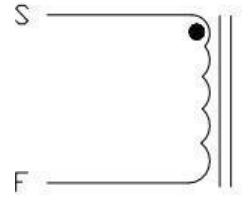

SCHEMATIC DRAWING

series	A	B	C	D	E	a typ	b typ	c typ
XR0420	4.4±0.35	4.2±0.25	1.8±0.2	0.8±0.3	2.0±0.3	2.2	5.2	2.5

## 5. Marking

The inductor is marked with a 3-digit code

Nominal Inductance	
Example	Nominal Value
1R0	1.0 $\mu$ H
100	10 $\mu$ H
101	100 $\mu$ H



Note : Using Ink for marking

## 6. Structure and Components

Symbol	Components	Material
a	MARKING	Ink(black)
b	CORE	Alloy Sponge Powder
c	WIRE	Polyurethane copper wire
d	Terminal	Copper plated with Sn



### 7. Electrical characteristics

•XR0420 TYPE:

Part No.	Inductance	DC Resistance	Saturation Current	Heating Rating Current
	L0 (μH)	DCR (m )	Isat (A)	Irms (A)
	±20 %, 100 kHz, 1V	MAX.	TYP.	TYP.
XR0420-R10M	0.1	4	22	13
XR0420-R22M	0.22	6.6	12.5	9.5
XR0420-R33M	0.33	11	12	10
XR0420-R47M	0.47	14	9.5	7.5
XR0420-R56M	0.56	16	9	7
XR0420-R68M	0.68	18	8	7
XR0420-1R0M	1.0	27	7	6
XR0420-1R2M	1.2	27	6.5	6
XR0420-1R5M	1.5	46	5.5	5
XR0420-2R2M	2.2	58	5	4.5
XR0420-3R3M	3.3	87	3.5	3.3
XR0420-4R7M	4.7	105	3	2.8
XR0420-6R8M	6.8	175	2.5	2.4
XR0420-100M	10	282	2	1.6
XR0420-220M	22	363	1.4	1.2

• Notes

1. All test data is referenced to 25 °C ambient
2. Operating temperature range - 55 °C to + 125 °C
3. Irms (A):DC current (A) that will cause an approximate ΔT of 40 °C(reference ambient temperature is 25 °C)
4. Isat(A):DC current (A) that will cause L0 to drop approximately 30 %
5. The part temperature (ambient + temp rise) should not exceed 125 °C under worst case operating conditions.  
Circuit design, component placement, PWB trace size and thickness, airflow and other cooling provisions all affect the part temperature. Part temperature should be verified in the end application.
6. Absolute maximum voltage 30VDC

### 8. Reliability Test

Item	Specification and Requirement	Test Method								
Solderability	1. No case deformation or change in appearance  2. New solder coverage More than 90%	1. Preheat: $155^{\circ}\text{C} \pm 5^{\circ}\text{C}$ , $60\text{S} \pm 2\text{S}$ 2. Tin: lead-free. 3. Temperature: $245^{\circ}\text{C} \pm 5^{\circ}\text{C}$ , flux $3.0\text{S} \pm 0.5\text{S}$ .								
Mechanical shock	1. No case deformation or change in appearance  2. $\Delta\text{L}/\text{Lo} \leq \pm 10\%$	1. Acceleration: 100G 2. Pulse time: 6ms 3. 3 times in each positive and negative direction of 3 mutual perpendicular directions								
Mechanical vibration	1. No case deformation or change in appearance  2. $\Delta\text{L}/\text{Lo} \leq \pm 10\%$	1. The test samples shall be soldered to the board. Then it shall be submitted to below test conditions. <table border="1" style="margin: 10px auto;"> <tr> <td>Fre. Range</td> <td>10~55Hz</td> </tr> <tr> <td>Total Amplitude</td> <td>1.5mm</td> </tr> <tr> <td>Sweeping Method</td> <td>10Hz to 55Hz to 10Hz</td> </tr> <tr> <td>Time</td> <td>For 2 hours on each X,Y,Z axis.</td> </tr> </table> 2. Recovery: At least 2 hours of recovery under the standard condition after the test, followed by the measurement within $24 \pm 2$ hours.	Fre. Range	10~55Hz	Total Amplitude	1.5mm	Sweeping Method	10Hz to 55Hz to 10Hz	Time	For 2 hours on each X,Y,Z axis.
Fre. Range	10~55Hz									
Total Amplitude	1.5mm									
Sweeping Method	10Hz to 55Hz to 10Hz									
Time	For 2 hours on each X,Y,Z axis.									
Thermal Shock	Inductance change: Within $\pm 10\%$ Without distinct damage in appearance	1. First $-55^{\circ}\text{C}$ for 30 minutes, last $125^{\circ}\text{C}$ for 30 minutes as 1 cycle. Go through 1000 cycles. 2. Max transfer time is 2 minutes. 3. Measured at room temperature after placing for $24 \pm 2$ hours								
Humidity Resistance	Inductance change: Within $\pm 10\%$ Without distinct damage in appearance	1. Reflow 2 times, 2. $85^{\circ}\text{C}$ , 85%RH, 1000 hours 3. Measured at room temperature after placing for $24 \pm 2$ hours								
Low temperature storage	Inductance change: Within $\pm 10\%$ Without distinct damage in appearance	1. Temperature: $-55 \pm 2^{\circ}\text{C}$ 2. Time: 1000 hours 3. Measured at room temperature after placing for $24 \pm 2$ hours								

# 东莞市祥如电子有限公司

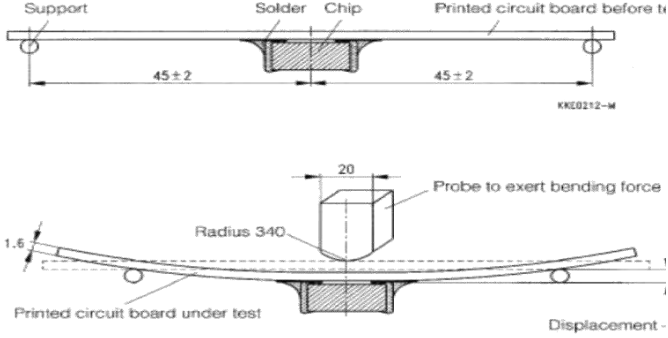
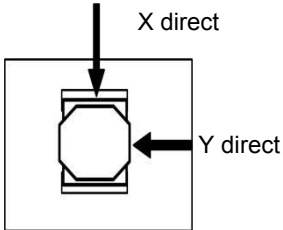
<p style="text-align: center;">High temperature storage</p>	<p>Inductance change: Within <math>\pm 10\%</math> Without distinct damage in appearance</p>	<ol style="list-style-type: none"> <li>1. Temperature: <math>+125 \pm 2^\circ\text{C}</math></li> <li>2. Time: 1000 hours</li> <li>3. Measured at room temperature after placing for <math>24 \pm 2</math> hours</li> </ol>
<p style="text-align: center;">Board Flex</p>	<p>Inductance change: Within <math>\pm 10\%</math> Without distinct damage in appearance</p>	<ol style="list-style-type: none"> <li>1、 Run through IR reflow for 2 times;</li> <li>2、 Place the 100mm X 40mm board into a fixture similar to the one shown in below Figure with the component facing down</li> <li>3、 The apparatus shall consist of mechanical means to apply a force which will bend the board (D) x = 2 mm minimum.</li> <li>4、 The duration of the applied forces shall be <math>60 \pm 5</math> sec. The force is to be applied only once to the board.</li> </ol> 
<p style="text-align: center;">Terminal Strength</p>	<p>No removal or split of the termination or other defects shall occur.</p>	<ol style="list-style-type: none"> <li>1、 The test samples shall be soldered to the board</li> <li>2、 Push the product vertically from the side of the sample using the thrust tester.</li> <li>3、 Automotive electronics: 17.7N, 60S <math>\pm</math> 1s, X , Y direct.</li> </ol> 

## Recommended Soldering Technologies

### (1) Re-flowing Profile

Preheat condition: 150 ~200°C/60~180sec.

Allowed time above 217°C: 80~120sec.

Max temp: 260°C

Max time at max temp: 10 sec.

Solder paste: Sn/3.0Ag/0.5Cu

Allowed Reflow time: 2x max

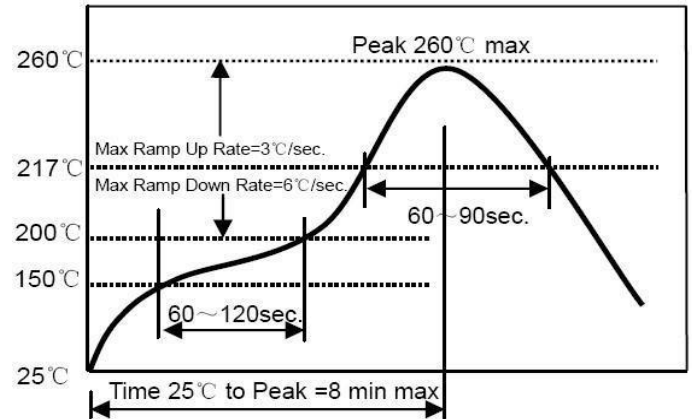

### (2) Iron Soldering Profile

Iron soldering power: Max. 30W

Pre-heating: 150°C/60sec.

Soldering time: 3sec. Max.

Solder paste: Sn/3.0Ag/0.5Cu

Max.1 times for iron soldering

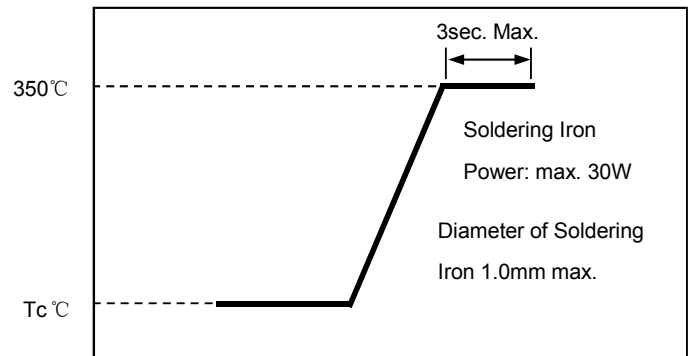

# 东莞市祥如电子有限公司

## 9. Packaging, Storage and Transportation

- Tape Carrier Packaging:

Type	Standard Quantity (pcs/reel)	Type	Standard Quantity (pcs/reel)
XR0412	2000/3000	XR0640	1000
XR0420	3000	XR0650	1000
XR0518	2000/2500	XR1040	500/1000
XR0520	2000/2500	XR1045	800
XR0530	1500/2000	XR1240	500
XR0620	1000/1500	XR1250	500
XR0624	1000/1500	XR1265	400/500
XR0630	1000		

- Taping Drawings (UNIT:mm)

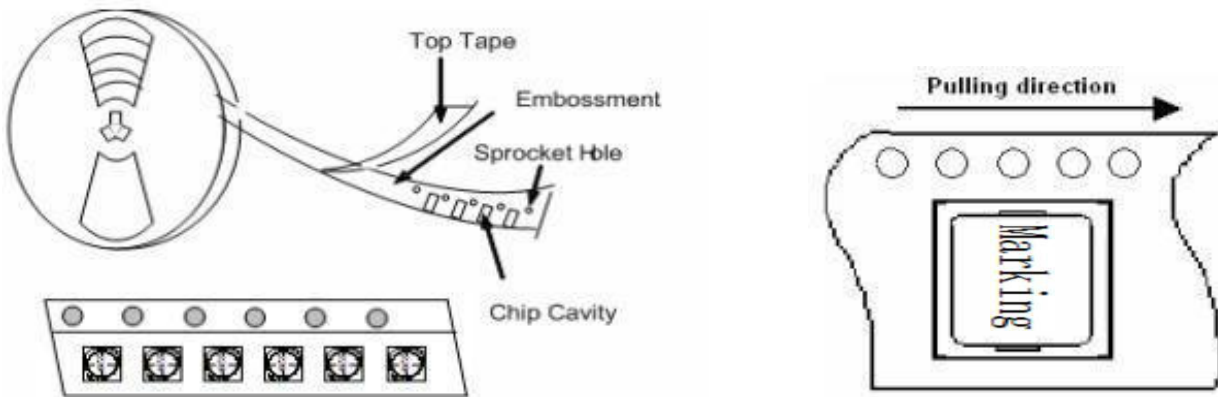

- Reel and Taping Dimensions (UNIT:mm)

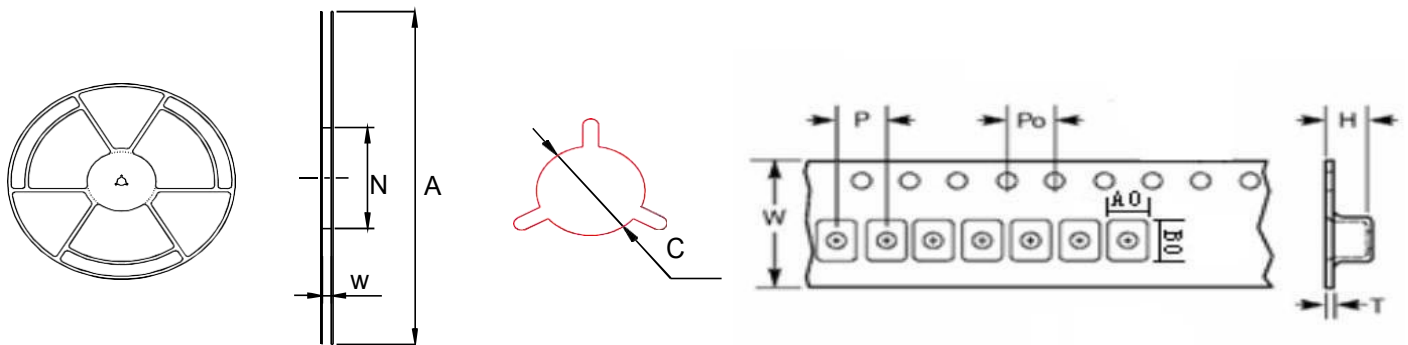



# 东莞市祥如电子有限公司

Type	Reel Dimensions (mm)				Tape Dimensions (mm)							
	A	N	W	C	W	P	P0	A0	B0	H	T	
XR0412	330 +2/-0	100 +2/-0	12.4 +2/-0	13.2 ±0.2	12±0.3	8±0.1	4±0.1	4.4±0.1	4.9±0.1	1.5±0.05	0.3±0.05	
XR0420	330 +2/-0	100 +2/-0	12.4 +2/-0	13.2 ±0.2	12±0.3	8±0.1	4±0.1	4.4±0.1	4.9±0.1	2.3±0.05	0.35±0.05	
XR0518	330 +2/-0	100 +2/-0	12.4 +2/-0	13.2 ±0.2	12±0.3	8±0.1	4±0.1	5.4±0.1	5.9±0.1	2.1±0.05	0.35±0.05	
XR0520	330 +2/-0	100 +2/-0	12.4 +2/-0	13.2 ±0.2	12±0.3	8±0.1	4±0.1	5.5±0.1	5.85±0.1	2.2±0.1	0.35±0.05	
XR0530	330 +2/-0	100 +2/-0	12.4 +2/-0	13.2 ±0.2	12±0.3	8±0.1	4±0.1	5.4±0.1	5.9±0.1	3.3±0.05	0.35±0.05	
XR0620	330 +2/-0	100 +2/-0	16.4 +2/-0	13.2 ±0.2	16±0.3	12±0.1	4±0.1	6.9±0.1	7.5±0.1	2.1±0.05	0.35±0.05	
XR0624	330 +2/-0	100 +2/-0	16.4 +2/-0	13.2 ±0.2	16±0.3	12±0.1	4±0.1	6.9±0.1	7.5±0.1	2.7±0.05	0.35±0.05	
XR0630	330 +2/-0	100 +2/-0	16.4 +2/-0	13.2 ±0.2	16±0.3	12±0.1	4±0.1	6.9±0.1	7.5±0.1	3.3±0.05	0.35±0.05	
XR0640	330 +2/-0	100 +2/-0	16.4 +2/-0	13.2 ±0.2	16±0.3	12±0.1	4±0.1	6.9±0.1	7.5±0.1	4.2±0.1	0.35±0.05	
XR0650	330 +2/-0	100 +2/-0	16.4 +2/-0	13.2 ±0.2	16±0.3	12±0.1	4±0.1	6.9±0.1	7.5±0.1	5.2±0.1	0.4±0.05	
XR1040	330 +2/-0	100 +2/-0	24.4 +2/-0	13.2 ±0.2	24±0.3	16±0.1	4±0.1	10.4±0.1	11.5±0.1	4.3±0.1	0.35±0.05	
XR1045	330 +2/-0	100 +2/-0	24.4 +2/-0	13.2 ±0.2	24±0.3	16±0.1	4±0.1	10.4±0.1	11.5±0.1	4.8±0.1	0.35±0.05	
XR1240	330 +2/-0	100 +2/-0	24.4 +2/-0	13.2 ±0.2	24±0.3	16±0.1	4±0.1	13.4±0.1	14.4±0.1	4.3±0.1	0.5±0.05	
XR1250	330 +2/-0	100 +2/-0	24.4 +2/-0	13.2 ±0.2	24±0.3	16±0.1	4±0.1	13.2±0.1	14.4±0.1	5.3±0.1	0.5±0.05	
XR1265	330 +2/-0	100 +2/-0	24.4 +2/-0	13.2 ±0.2	24±0.3	16±0.1	4±0.1	13.2±0.1	14.4±0.1	6.3±0.1	0.5±0.05	

# 东莞市祥如电子有限公司

- Peel force of top cover tape

The peel speed shall be about 300mm/minute

The peel force of top cover tape shall be between 0.1 to 1.3 N

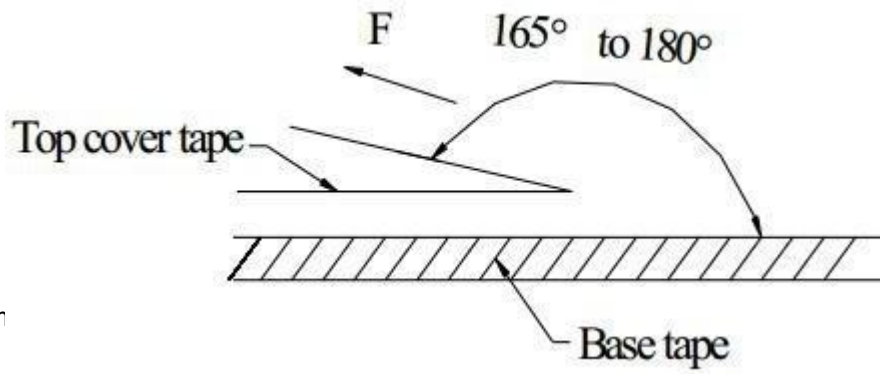

- Label making

Label on the reel

- Customer's part Number
- Lot Number
- Quantity
- date code

Shipping Label

- Customer's part Number
- Manufacturer's part Number
- Quantity
- date code

