

Features

- 3rd generation SiC MOSFET technology
- High blocking voltage with low on-resistance
- High-speed switching with low capacitances
- Fast intrinsic diode with low reverse recovery (Q_{rr})
- Halogen free, RoHS compliant

Benefits

- Reduce switching losses and minimize gate ringing
- Higher system efficiency
- Reduce cooling requirements
- Increase power density
- Increase system switching frequency

Applications

- Solar inverters
- EV motor drive
- High voltage DC/DC converters
- Switched mode power supplies
- Load switch

V_{DS}	1200V
$I_D(T_C=25^\circ\text{C})$	115A
$R_{DS(on)}$	16m Ω

Package TO-247-3L

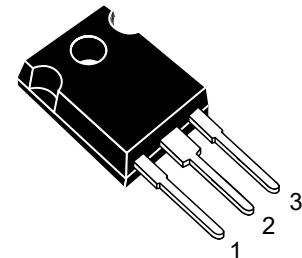

Equivalent Circuit

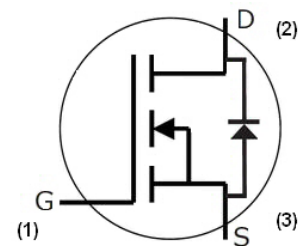

Maximum Ratings ($T_C = 25^\circ\text{C}$ unless otherwise specified)

Symbol	Parameter	Value	Unit	Test Conditions	Note
V_{DSmax}	Drain - Source Voltage	1200	V	$V_{GS} = 0\text{ V}, I_D = 100\ \mu\text{A}$	
V_{GSmax}	Gate - Source Voltage (dynamic)	-8/+19	V	AC ($f > 1\text{ Hz}$)	Note 1
V_{GSop}	Gate - Source Voltage (static)	-4/+15	V	Static	Note 2
I_D	Continuous Drain Current	115	A	$V_{GS} = 15\text{ V}, T_C = 25^\circ\text{C}$	Fig. 19
		85		$V_{GS} = 15\text{ V}, T_C = 100^\circ\text{C}$	
$I_{D(pulse)}$	Pulsed Drain Current	250	A	Pulse width t_p limited by T_{jmax}	
P_D	Power Dissipation	556	W	$T_C = 25^\circ\text{C}, T_J = 175^\circ\text{C}$	Fig. 20
T_J, T_{stg}	Operating Junction and Storage Temperature	-40 to +175	$^\circ\text{C}$		
T_L	Solder Temperature	260	$^\circ\text{C}$	1.6mm (0.063") from case for 10s	
M_d	Mounting Torque	1 8.8	Nm lbf-in	M3 or 6-32 screw	

Note (1): When using MOSFET Body Diode $V_{GSmax} = -4\text{V}/+19\text{V}$

Note (2): MOSFET can also safely operate at $0/+15\text{ V}$



Electrical Characteristics ($T_C = 25^\circ\text{C}$ unless otherwise specified)

Symbol	Parameter	Min.	Typ.	Max.	Unit	Test Conditions	Note
$V_{(BR)DSS}$	Drain-Source Breakdown Voltage	1200			V	$V_{GS} = 0\text{ V}, I_D = 100\ \mu\text{A}$	
$V_{GS(th)}$	Gate Threshold Voltage	1.8	2.5	3.6	V	$V_{DS} = V_{GS}, I_D = 23\ \text{mA}$	Fig. 11
			2.0		V	$V_{DS} = V_{GS}, I_D = 23\ \text{mA}, T_J = 175^\circ\text{C}$	
I_{DSS}	Zero Gate Voltage Drain Current		1	50	μA	$V_{DS} = 1200\ \text{V}, V_{GS} = 0\ \text{V}$	
I_{GSS}	Gate-Source Leakage Current		10	250	nA	$V_{GS} = 15\ \text{V}, V_{DS} = 0\ \text{V}$	
$R_{DS(on)}$	Drain-Source On-State Resistance	11.2	16	22.3	m Ω	$V_{GS} = 15\ \text{V}, I_D = 75\ \text{A}$	Fig. 4, 5, 6
			28.8			$V_{GS} = 15\ \text{V}, I_D = 75\ \text{A}, T_J = 175^\circ\text{C}$	
g_{fs}	Transconductance		53		S	$V_{DS} = 20\ \text{V}, I_{DS} = 75\ \text{A}$	Fig. 7
			47			$V_{DS} = 20\ \text{V}, I_{DS} = 75\ \text{A}, T_J = 175^\circ\text{C}$	
C_{iss}	Input Capacitance		6085		pF	$V_{GS} = 0\ \text{V}, V_{DS} = 1000\ \text{V}$ $f = 100\ \text{KHz}$ $V_{AC} = 25\ \text{mV}$	Fig. 17, 18
C_{oss}	Output Capacitance		230				
C_{riss}	Reverse Transfer Capacitance		13				
E_{oss}	C_{oss} Stored Energy		130		μJ		Fig. 16
E_{ON}	Turn-On Switching Energy (SiC Diode FWD)		4.64		mJ	$V_{DS} = 800\ \text{V}, V_{GS} = -4\ \text{V}/+15\ \text{V}, I_D = 75\ \text{A},$ $R_{G(ext)} = 5\ \Omega, L = 65.7\ \mu\text{H}, T_J = 175^\circ\text{C}$	Fig. 26
E_{OFF}	Turn Off Switching Energy (SiC Diode FWD)		2.93				
E_{ON}	Turn-On Switching Energy (Body Diode FWD)		7.79		mJ	$V_{DS} = 800\ \text{V}, V_{GS} = -4\ \text{V}/+15\ \text{V}, I_D = 75\ \text{A},$ $R_{G(ext)} = 5\ \Omega, L = 65.7\ \mu\text{H}, T_J = 175^\circ\text{C}$	Fig. 26
E_{OFF}	Turn Off Switching Energy (Body Diode FWD)		2.95				
$t_{d(on)}$	Turn-On Delay Time		174		ns	$V_{DD} = 800\ \text{V}, V_{GS} = -4\ \text{V}/15\ \text{V}$ $R_{G(ext)} = 5\ \Omega, I_D = 75\ \text{A}, L = 65.7\ \mu\text{H}$ Timing relative to V_{DS} , Inductive load	Fig. 27
t_r	Rise Time		28				
$t_{d(off)}$	Turn-Off Delay Time		84				
t_f	Fall Time		27				
$R_{G(int)}$	Internal Gate Resistance		2.6		Ω	$f = 1\ \text{MHz}, V_{AC} = 25\ \text{mV}$	
Q_{gs}	Gate to Source Charge		70		nC	$V_{DS} = 800\ \text{V}, V_{GS} = -4\ \text{V}/15\ \text{V}$ $I_D = 75\ \text{A}$ Per IEC60747-8-4 pg 21	Fig. 12
Q_{gd}	Gate to Drain Charge		60				
Q_g	Total Gate Charge		207				



Reverse Diode Characteristics ($T_C = 25^\circ\text{C}$ unless otherwise specified)

Symbol	Parameter	Typ.	Max.	Unit	Test Conditions	Note
V_{SD}	Diode Forward Voltage	4.6		V	$V_{GS} = -4\text{ V}, I_{SD} = 37.5\text{ A}, T_J = 25^\circ\text{C}$	Fig. 8, 9, 10
		4.2		V	$V_{GS} = -4\text{ V}, I_{SD} = 37.5\text{ A}, T_J = 175^\circ\text{C}$	
I_S	Continuous Diode Forward Current		112	A	$V_{GS} = -4\text{ V}, T_C = 25^\circ\text{C}$	Note 1
$I_{S,pulse}$	Diode pulse Current		250	A	$V_{GS} = -4\text{ V}$, pulse width t_p limited by T_{jmax}	Note 1
t_{rr}	Reverse Recover time	96		ns	$V_{GS} = -4\text{ V}, I_{SD} = 75\text{ A}, V_R = 800\text{ V}$ $dif/dt = 900\text{ A}/\mu\text{s}, T_J = 175^\circ\text{C}$	Note 1
Q_{rr}	Reverse Recovery Charge	604		nC		
I_{rrm}	Peak Reverse Recovery Current	15		A		
t_{rr}	Reverse Recover time	58		ns	$V_{GS} = -4\text{ V}, I_{SD} = 75\text{ A}, V_R = 800\text{ V}$ $dif/dt = 1400\text{ A}/\mu\text{s}, T_J = 175^\circ\text{C}$	Note 1
Q_{rr}	Reverse Recovery Charge	672		nC		
I_{rrm}	Peak Reverse Recovery Current	22		A		

Thermal Characteristics

Symbol	Parameter	Typ.	Unit	Test Conditions	Note
$R_{\theta JC}$	Thermal Resistance from Junction to Case	0.27	°C/W		Fig. 21
$R_{\theta JA}$	Thermal Resistance From Junction to Ambient	40			

Typical Performance

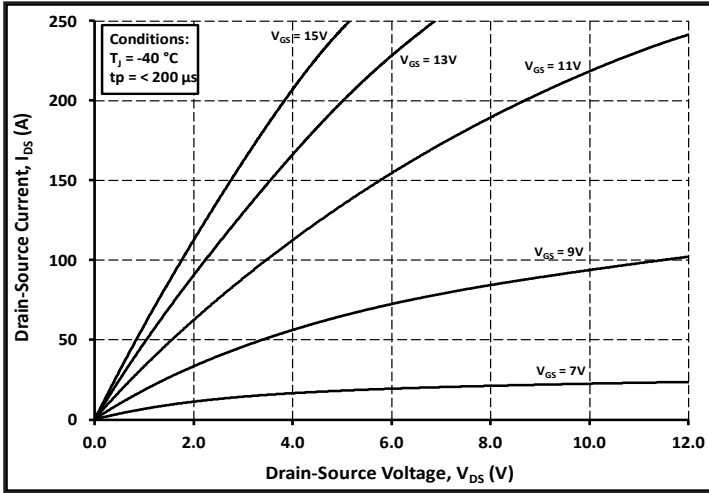

Figure 1. Output Characteristics $T_J = -40\text{ }^\circ\text{C}$

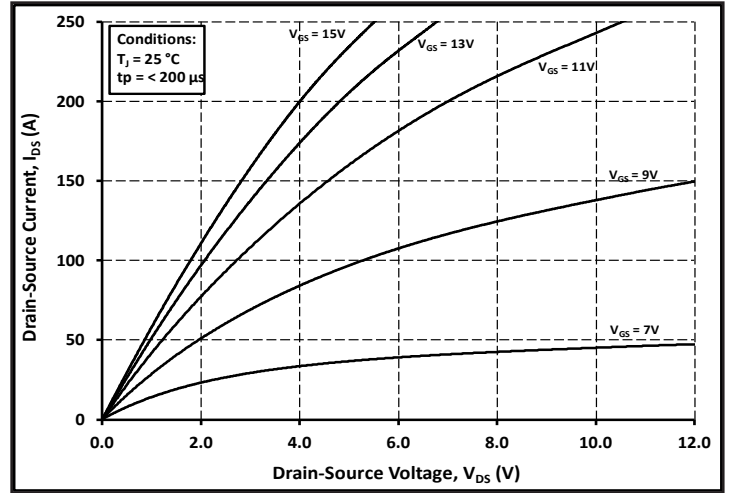

Figure 2. Output Characteristics $T_J = 25\text{ }^\circ\text{C}$

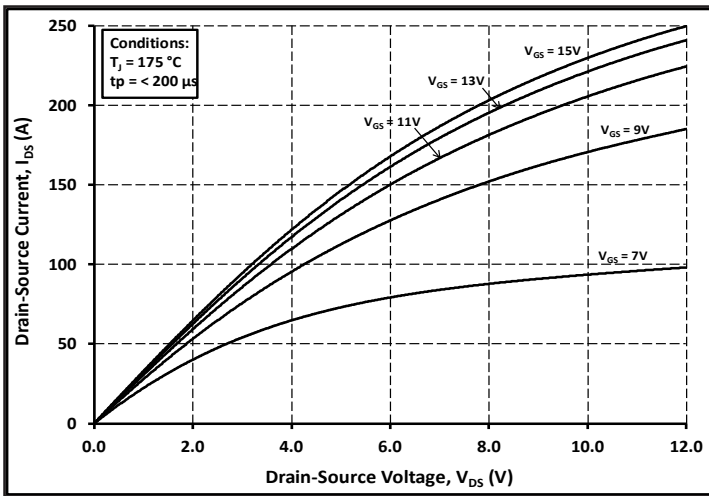

Figure 3. Output Characteristics $T_J = 175\text{ }^\circ\text{C}$

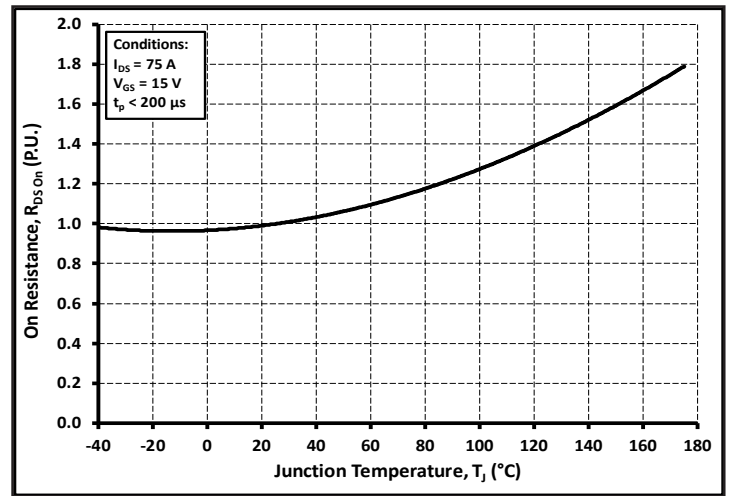

Figure 4. Normalized On-Resistance vs. Temperature

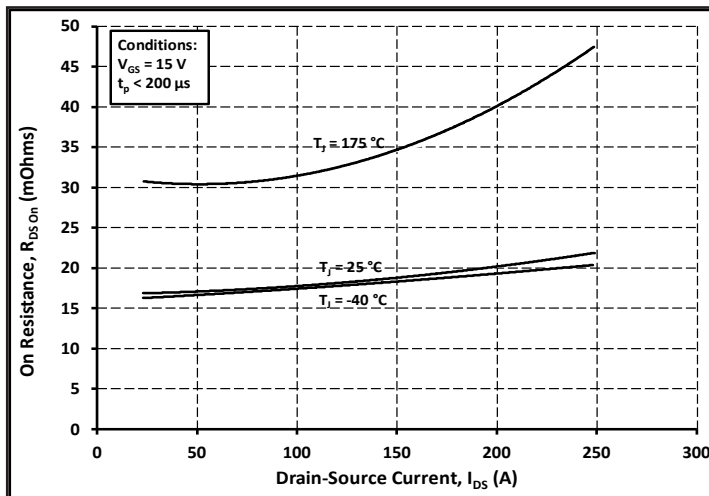

Figure 5. On-Resistance vs. Drain Current For Various Temperatures

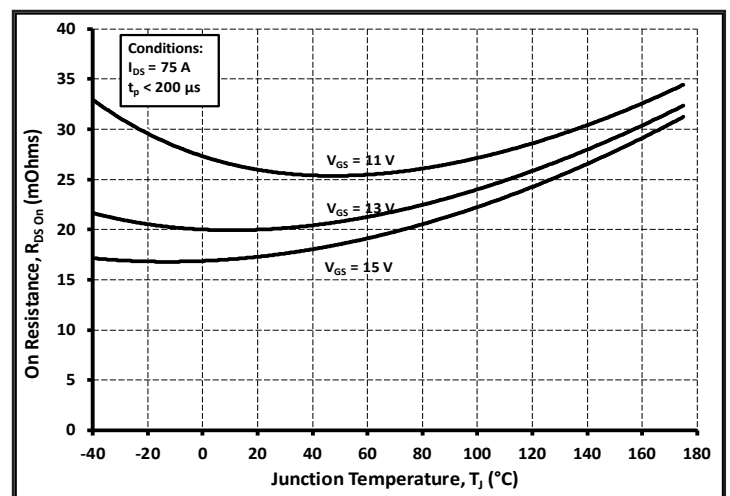

Figure 6. On-Resistance vs. Temperature For Various Gate Voltage

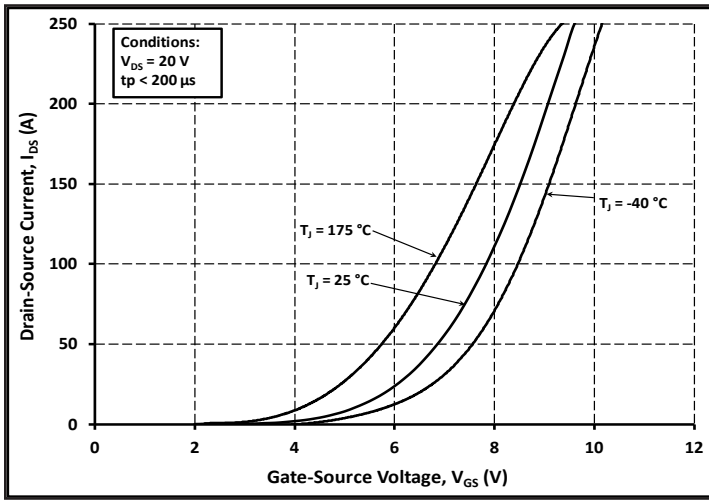

Figure 7. Transfer Characteristic for Various Junction Temperatures

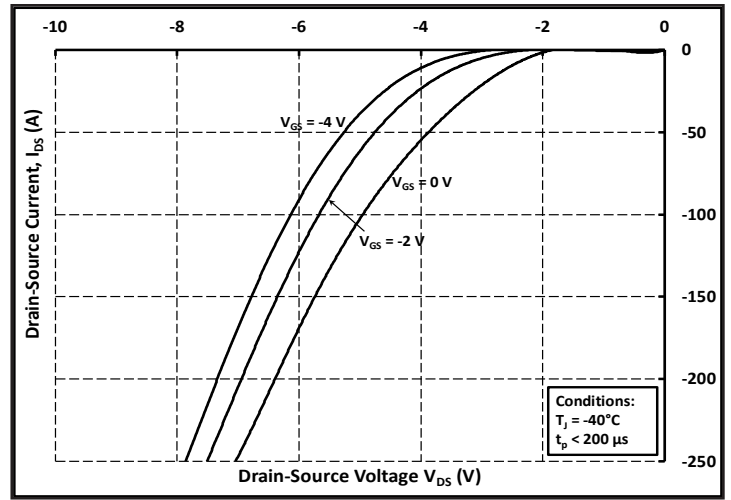

Figure 8. Body Diode Characteristic at -40 °C

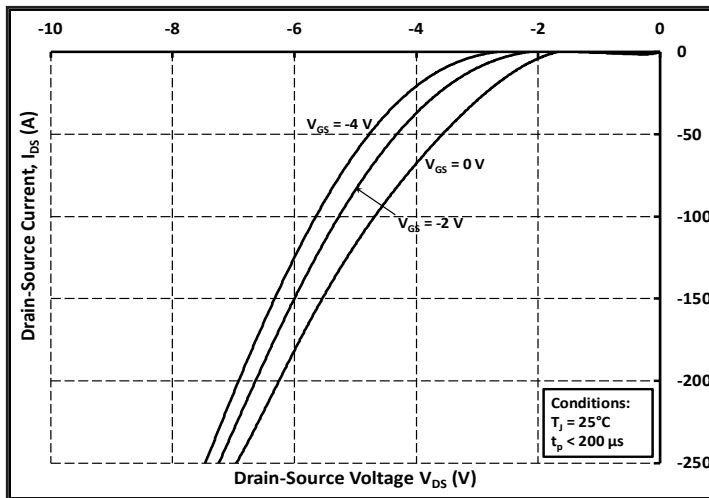

Figure 9. Body Diode Characteristic at 25 °C

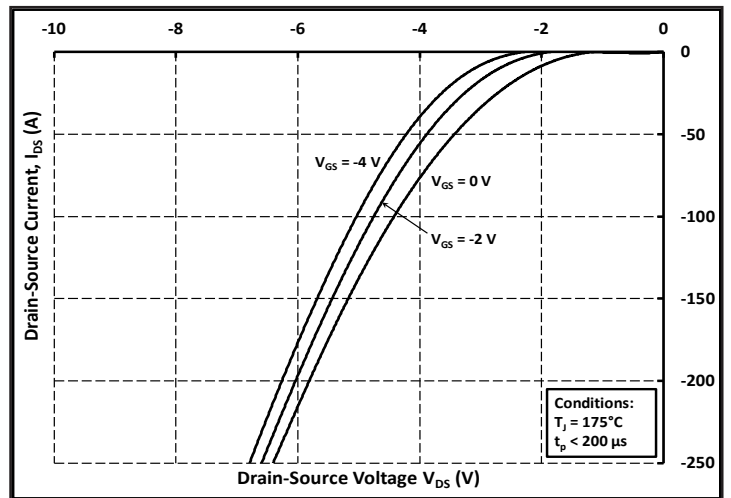

Figure 10. Body Diode Characteristic at 175 °C

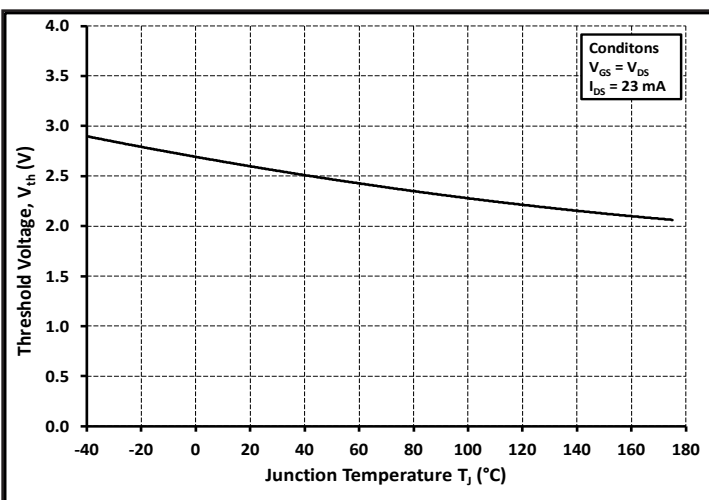

Figure 11. Threshold Voltage vs. Temperature

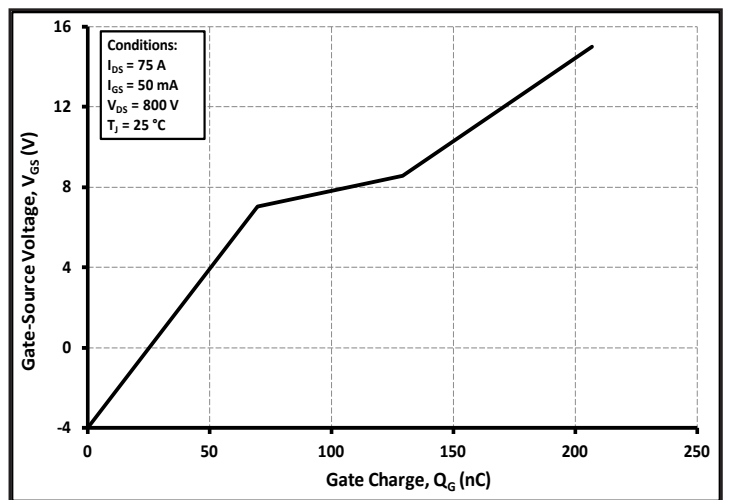

Figure 12. Gate Charge Characteristics

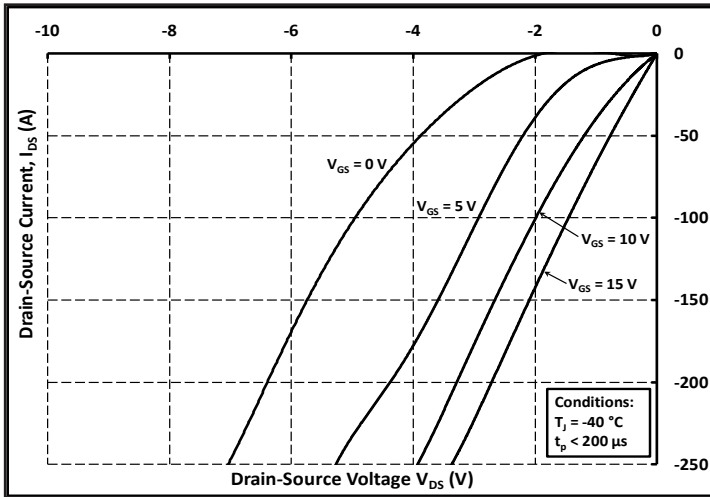

Figure 13. 3rd Quadrant Characteristic at -40 °C

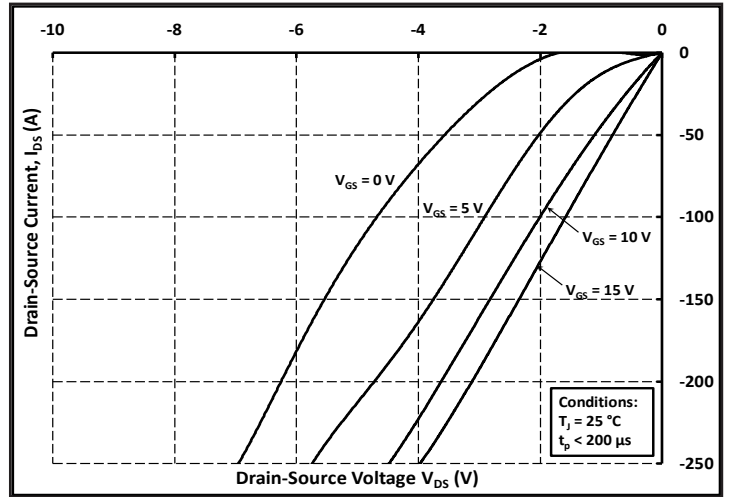

Figure 14. 3rd Quadrant Characteristic at 25 °C

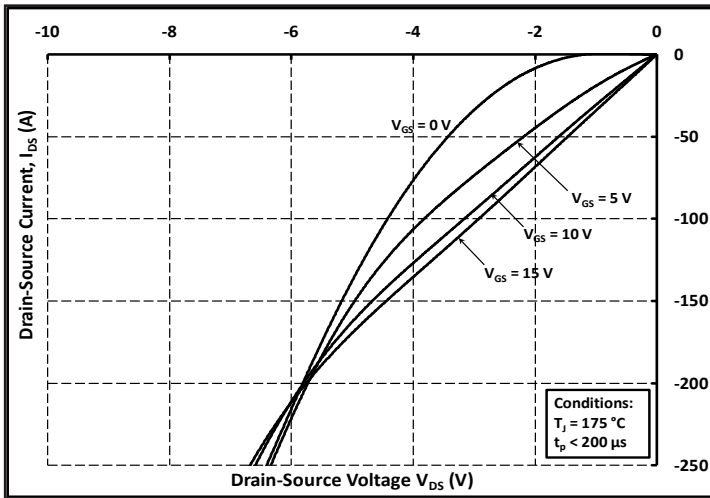

Figure 15. 3rd Quadrant Characteristic at 175 °C

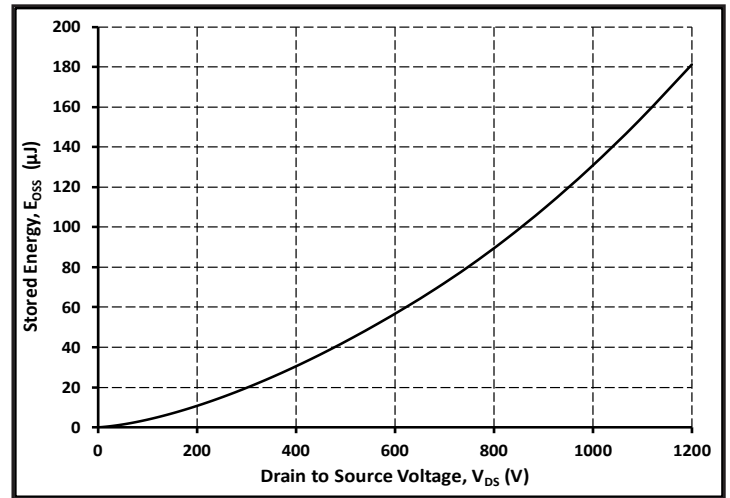

Figure 16. Output Capacitor Stored Energy

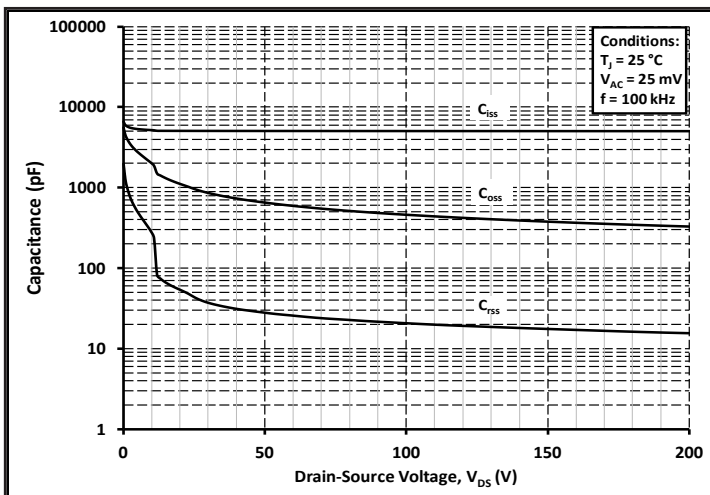

Figure 17. Capacitances vs. Drain-Source Voltage (0 - 200V)

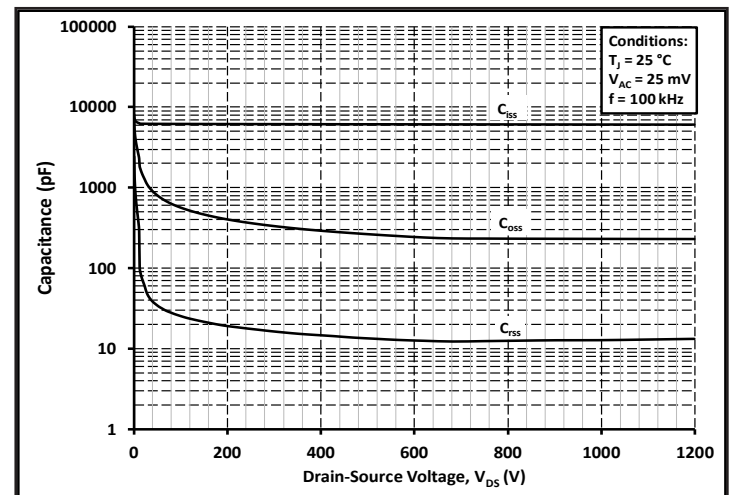

Figure 18. Capacitances vs. Drain-Source Voltage (0 - 1200V)

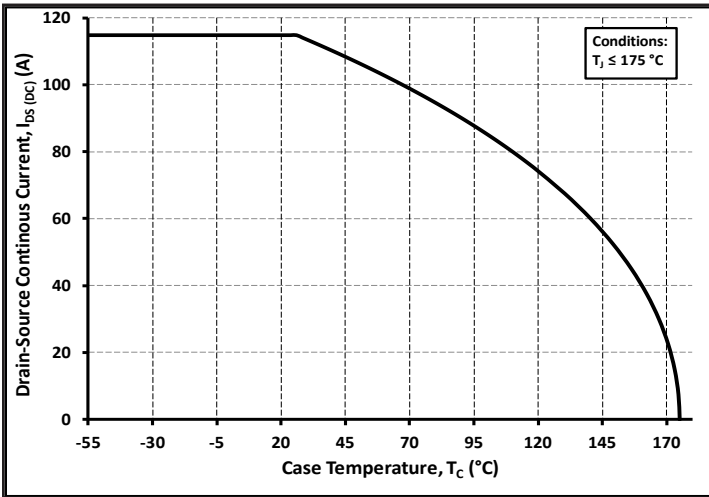

Figure 19. Continuous Drain Current Derating vs. Case Temperature

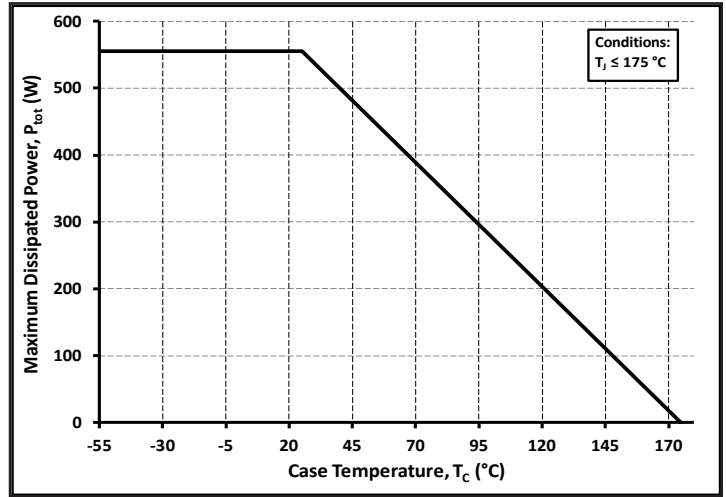

Figure 20. Maximum Power Dissipation Derating vs. Case Temperature

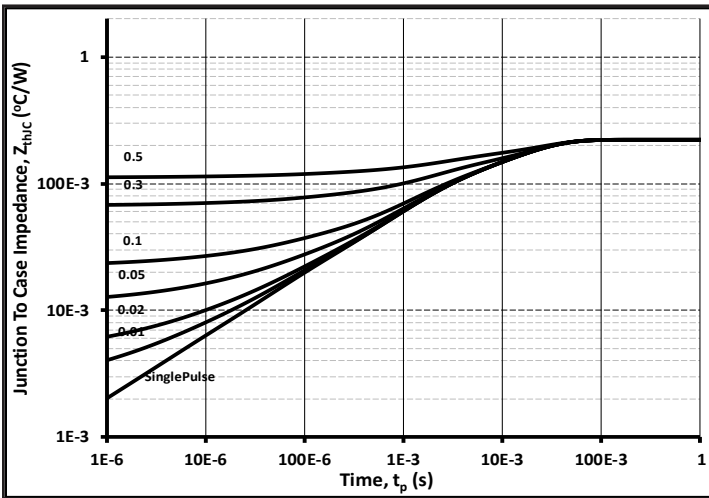

Figure 21. Transient Thermal Impedance (Junction - Case)

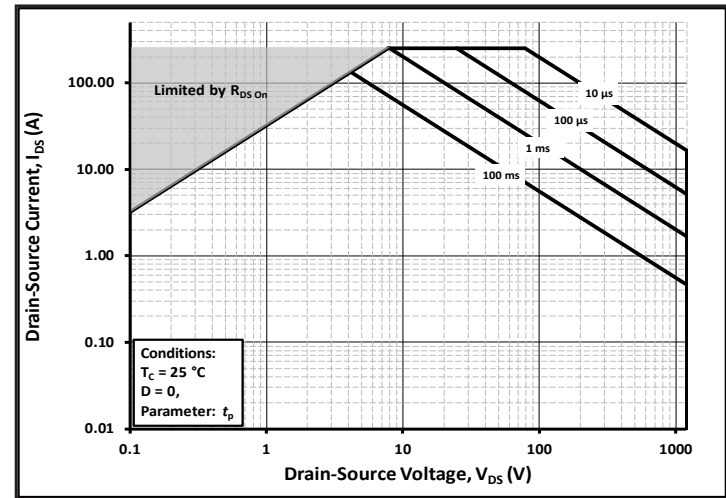

Figure 22. Safe Operating Area

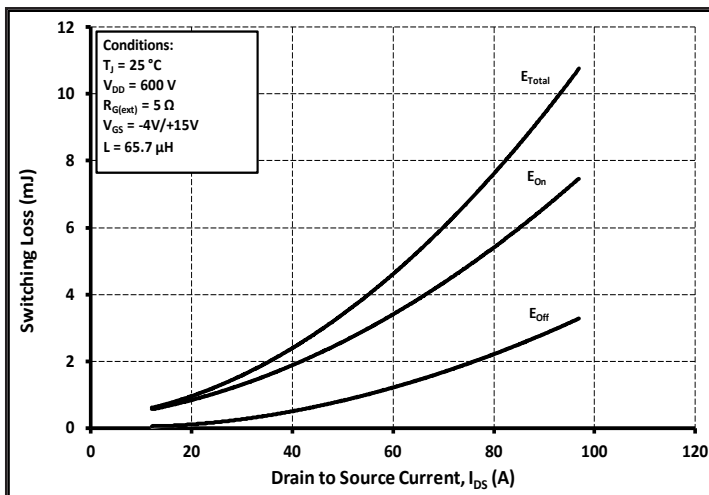

Figure 23. Clamped Inductive Switching Energy vs. Drain Current ($V_{DD} = 600V$)

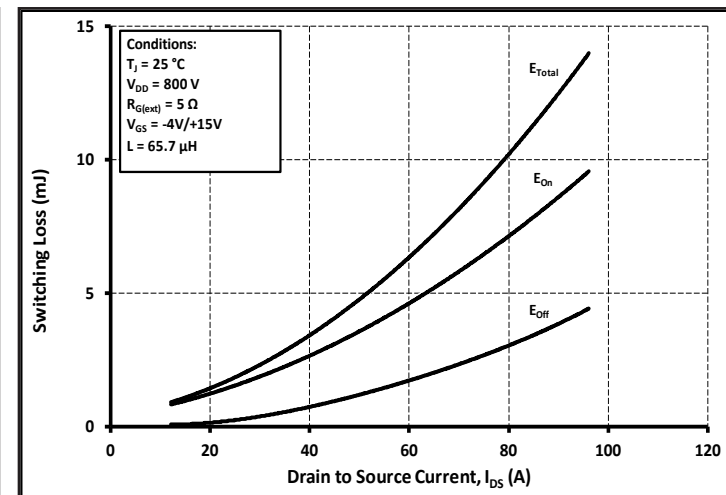

Figure 24. Clamped Inductive Switching Energy vs. Drain Current ($V_{DD} = 800V$)

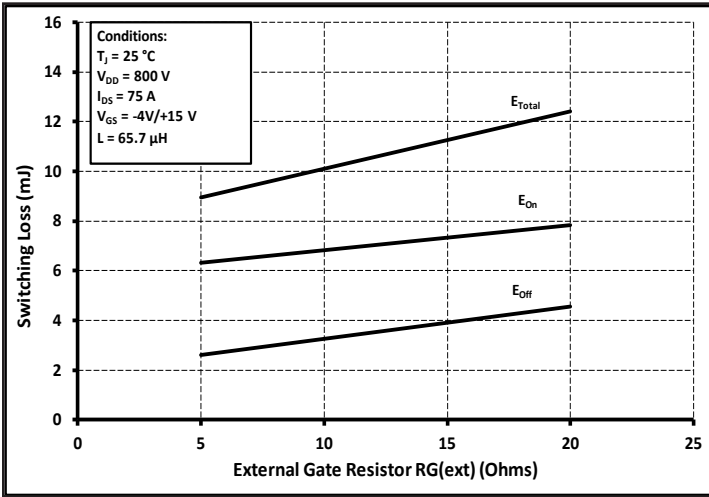

Figure 25. Clamped Inductive Switching Energy vs. $R_{G(ext)}$

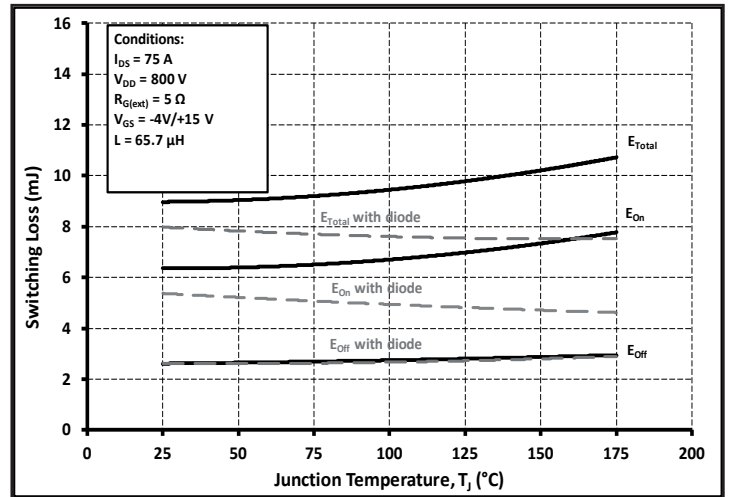

Figure 26. Clamped Inductive Switching Energy vs. Temperature

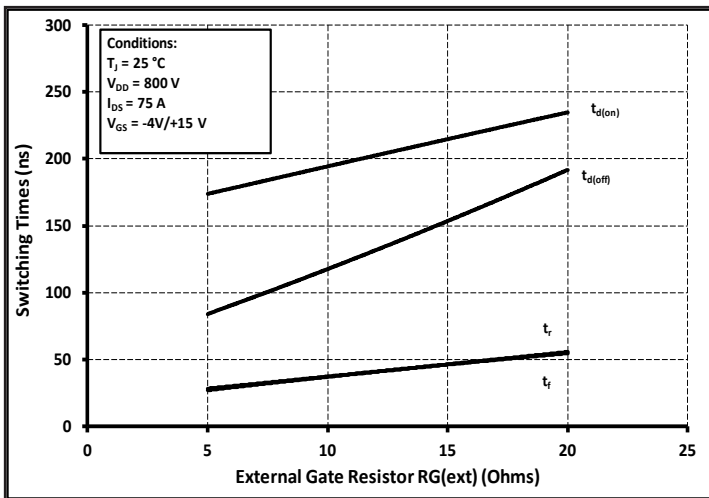

Figure 27. Switching Times vs. $R_{G(ext)}$

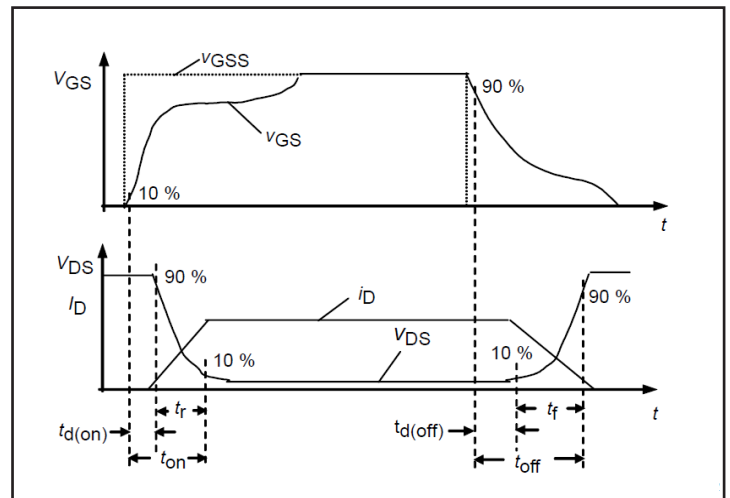

Figure 28. Switching Times Definition

Test Circuit Schematic

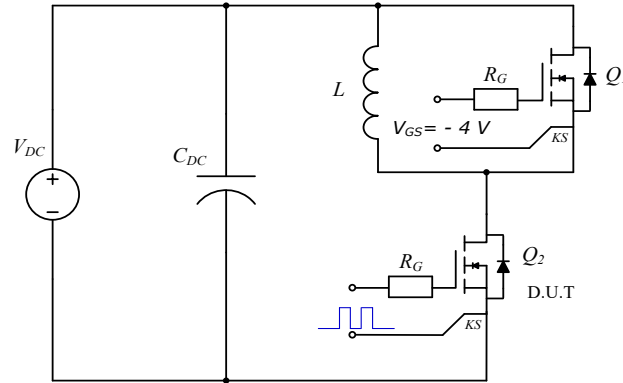

Figure 29. Clamped Inductive Switching Waveform Test Circuit

Note (3): Turn-off and Turn-on switching energy and timing values measured using SiC MOSFET Body Diode as shown above.



MDDG2C120R016K3

1200V N-Channel SiC Power MOSFET

Package Dimensions

Package TO-247-3

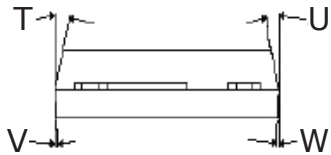
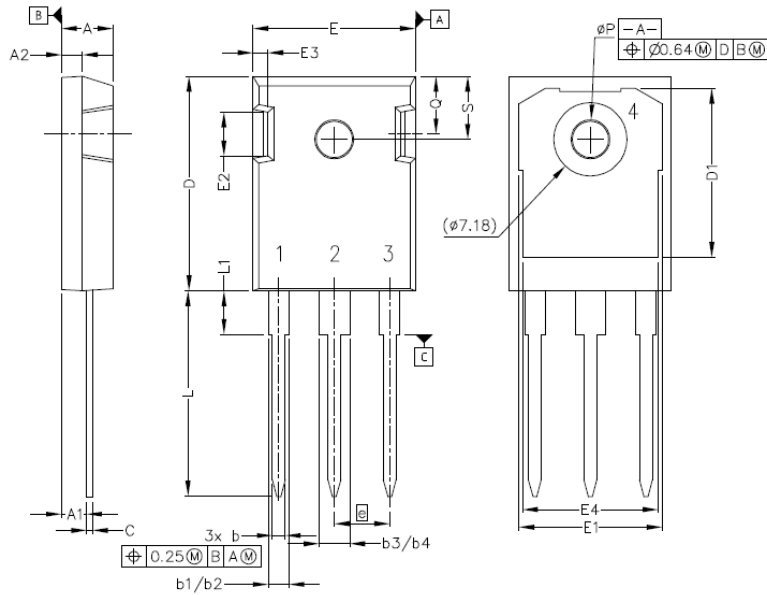

Pinout Information:

- Pin 1 = Gate
- Pin 2, 4 = Drain
- Pin 3 = Source

POS	Inches		Millimeters	
	Min	Max	Min	Max
A	.190	.205	4.83	5.21
A1	.090	.100	2.29	2.54
A2	.075	.085	1.91	2.16
b	.042	.052	1.07	1.33
b1	.075	.095	1.91	2.41
b2	.075	.085	1.91	2.16
b3	.113	.133	2.87	3.38
b4	.113	.123	2.87	3.13
c	.022	.027	0.55	0.68
D	.819	.831	20.80	21.10
D1	.640	.695	16.25	17.65
D2	.037	.049	0.95	1.25
E	.620	.635	15.75	16.13
E1	.516	.557	13.10	14.15
E2	.145	.201	3.68	5.10
E3	.039	.075	1.00	1.90
E4	.487	.529	12.38	13.43
e	.214 BSC		5.44 BSC	
N	3		3	
L	.780	.800	19.81	20.32
L1	.161	.173	4.10	4.40
ØP	.138	.144	3.51	3.65
Q	.216	.236	5.49	6.00
S	.238	.248	6.04	6.30
T	9°	11°	9°	11°
U	9°	11°	9°	11°
V	2°	8°	2°	8°
W	2°	8°	2°	8°

Recommended Solder Pad Layout

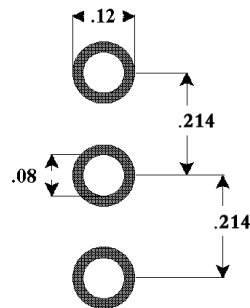

TO-247-3