

PRODUCT CHARACTERISTICS

VDSS	500V
$R_{DS(on)typ}(V_{GS}=10V)$	2.2Ω
Qg@type	18nC
ID	5A

APPLICATIONS

- High frequency switching mode power supply
- Electronic ballast
- LED power supply

FEATURES

- * Fast Switching Capability
- * Avalanche Energy Specified
- * Improved dv/dt Capability, High Ruggedness

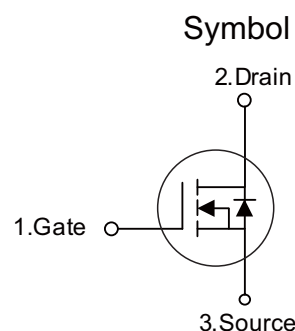
ORDER INFORMATION

Order codes		Package	Packing
Halogen-Free	Halogen		
N/A	MOT5N50XD	TO-252	2500 pieces /Reel
N/A	MOT5N50XC	TO-251	70 pieces/Tube

ABSOLUTE MAXIMUM RATINGS (T_C = 25°C, unless otherwise specified)

PARAMETER	SYMBOL	RATINGS	UNIT
Drain-Source Voltage	V _{DS}	500	V
Gate-Source Voltage	V _{GS}	±30	V
Drain Current	Continuous	I _D	5
	Pulsed (Note 2)	I _{DM}	10
Avalanche Energy	Single Pulsed (Note 3)	E _{AS}	151
Peak Diode Recovery dv/dt (Note 4)	dv/dt	4.5	V/ns
Power Dissipation	P _D	50	W
Junction Temperature	T _J	+150	°C
Storage Temperature	T _{STG}	-55~+150	°C

- Notes: 1. Absolute maximum ratings are those values beyond which the device could be permanently damaged. Absolute maximum ratings are stress ratings only and functional device operation is not implied.
2. Repetitive Rating: Pulse width limited by maximum junction temperature.
3. L = 10mH, I_{AS} = 5.5A, V_{DD} = 50V, R_G = 25 Ω Starting T_J = 25°C
4. I_{SD} ≤ 5.0A, di/dt ≤ 100A/μs, V_{DD} ≤ BV_{DSS}, Starting T_J = 25°C

■ ELECTRICAL CHARACTERISTICS ($T_C = 25^\circ\text{C}$, unless otherwise specified)

PARAMETER	SYMBOL	TEST CONDITIONS	MIN	TYP	MAX	UNIT
OFF CHARACTERISTICS						
Drain-Source Breakdown Voltage	BV_{DSS}	$I_D=250\mu\text{A}$, $V_{GS}=0\text{V}$	500	-	-	V
Breakdown Voltage Temperature Coefficient	$\Delta BV_{DSS}/\Delta T_J$	Reference to 25°C , $I_D=250\mu\text{A}$	-	0.5	-	$\text{V}/^\circ\text{C}$
Drain-Source Leakage Current	I_{DSS}	$V_{DS}=500\text{V}$, $V_{GS}=0\text{V}$	-	-	1	μA
		$V_{DS}=400\text{V}$, $T_C=125^\circ\text{C}$	-	-	10	
Gate- Source Leakage Current	Forward	I_{GSS}	-	-	100	nA
	Reverse				-100	
ON CHARACTERISTICS						
Gate Threshold Voltage	$V_{GS(TH)}$	$V_{DS}=V_{GS}$, $I_D=250\mu\text{A}$	2.0	-	4.0	V
Static Drain-Source On-State Resistance	$R_{DS(ON)}$	$V_{GS}=10\text{V}$, $I_D=2.5\text{A}$	-	2.2	3.0	Ω
DYNAMIC CHARACTERISTICS						
Input Capacitance	C_{ISS}	$V_{GS}=0\text{V}$, $V_{DS}=25\text{V}$, $f=1.0\text{MHz}$	-	625	-	pF
Output Capacitance	C_{OSS}		-	80	-	pF
Reverse Transfer Capacitance	C_{RSS}		-	15	-	pF
SWITCHING CHARACTERISTICS						
Total Gate Charge	Q_G	$V_{GS}=10\text{V}$, $V_{DS}=400\text{V}$, $I_D=5\text{A}$ (Note 1, 2)	-	18	-	nC
Gate to Source Charge	Q_{GS}		-	2.2	-	nC
Gate to Drain Charge	Q_{GD}		-	9.7	-	nC
Turn-ON Delay Time	$t_{D(ON)}$	$V_{DD}=250\text{V}$, $I_D=5\text{A}$, $R_G=25\Omega$ (Note 1, 2)	-	12	-	ns
Rise Time	t_R		-	46	-	ns
Turn-OFF Delay Time	$t_{D(OFF)}$		-	50	-	ns
Fall-Time	t_F		-	48	-	ns
SOURCE-DRAIN DIODE RATINGS AND CHARACTERISTICS						
Maximum Continuous Forward Current	I_S		-	-	5	A
Maximum Pulsed Forward Current	I_{SM}		-	-	20	A
Drain-Source Diode Forward Voltage	V_{SD}	$I_S=5\text{A}$, $V_{GS}=0\text{V}$	-	-	1.4	V
Reverse Recovery Time	t_{rr}	$I_S=5\text{A}$, $V_{GS}=0\text{V}$,	-	83	-	ns
Reverse Recovery Charge	Q_{RR}	$di_F/dt=100\text{A}/\mu\text{s}$ (Note 1)	-	0.25	-	μC

 Note: 1. Pulse Test: Pulse width $\leq 300\mu\text{s}$, Duty cycle $\leq 2\%$

2. Essentially independent of operating temperature

■ TYPICAL CHARACTERISTICS

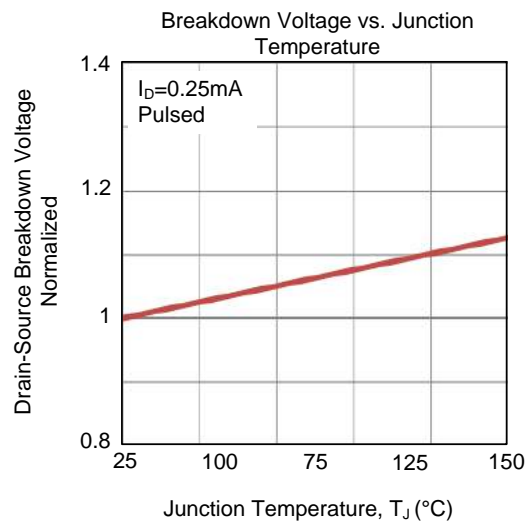
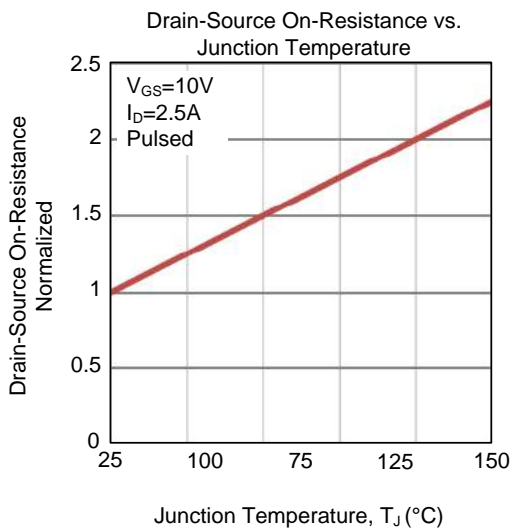
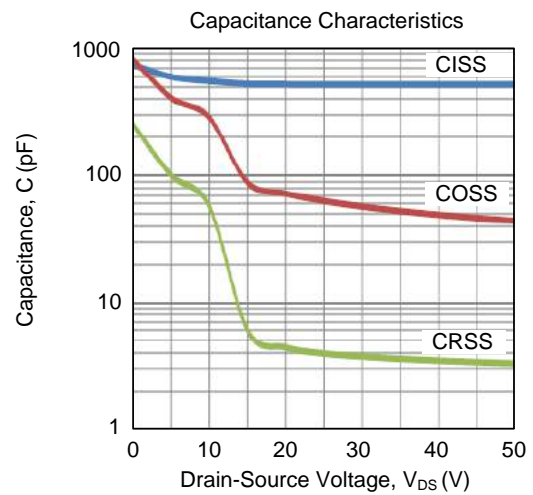
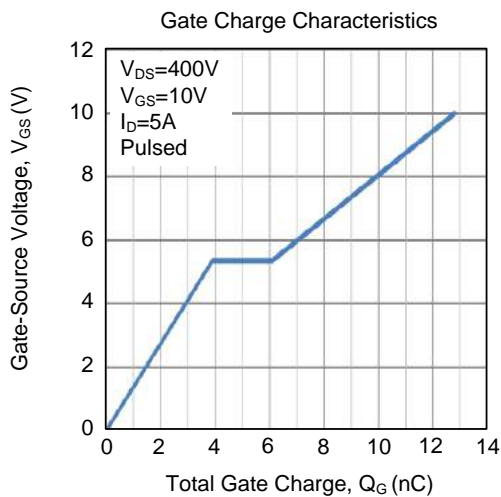
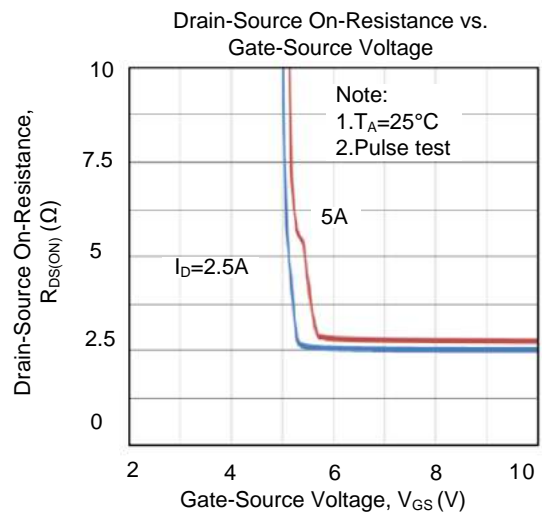
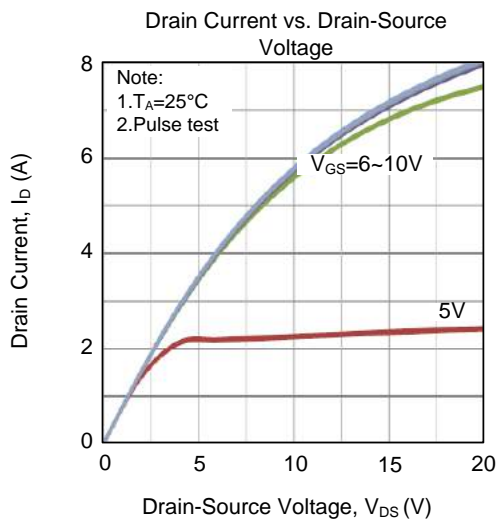

■ TYPICAL CHARACTERISTICS(Cont.)

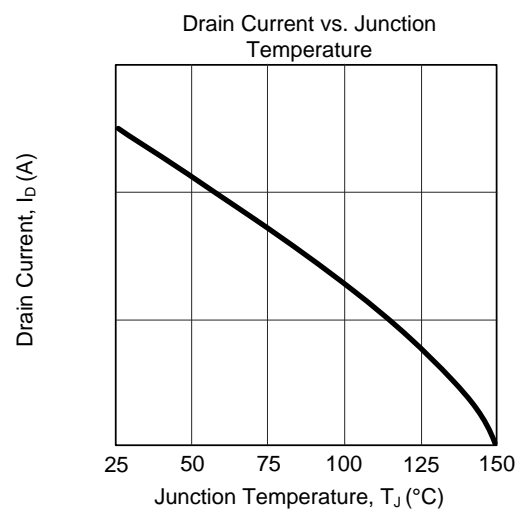
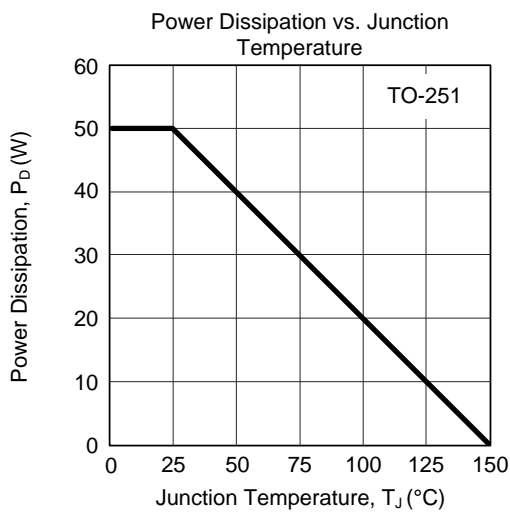
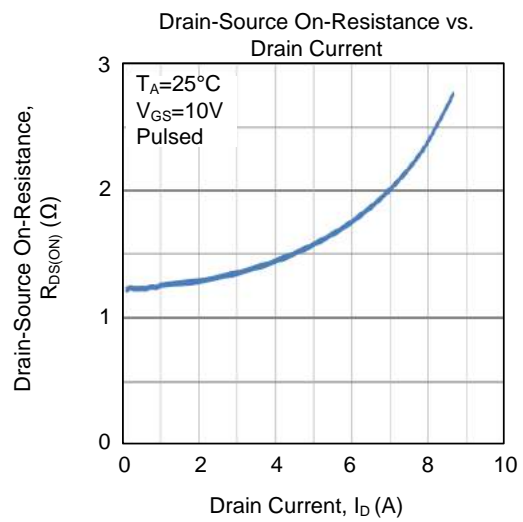
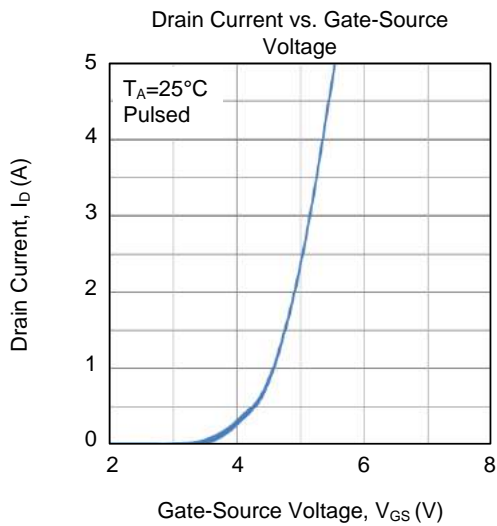
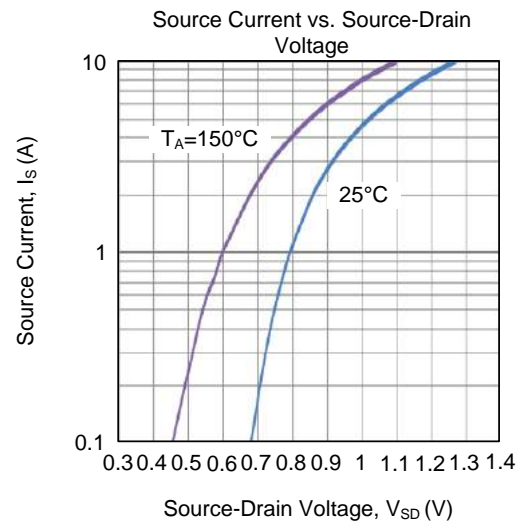
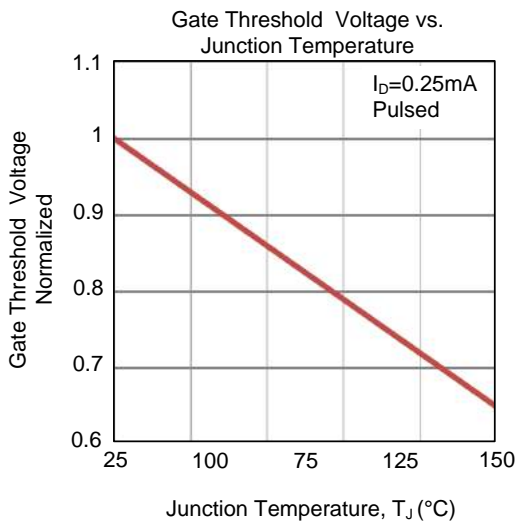

■ TYPICAL CHARACTERISTICS(Cont.)

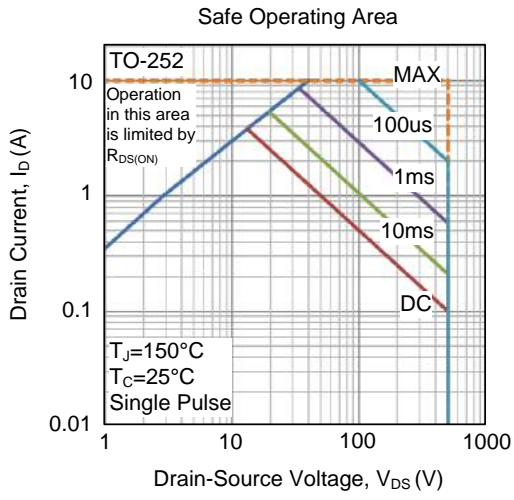

■ TO-251-3L PACKAGE OUTLINE DIMENSIONS

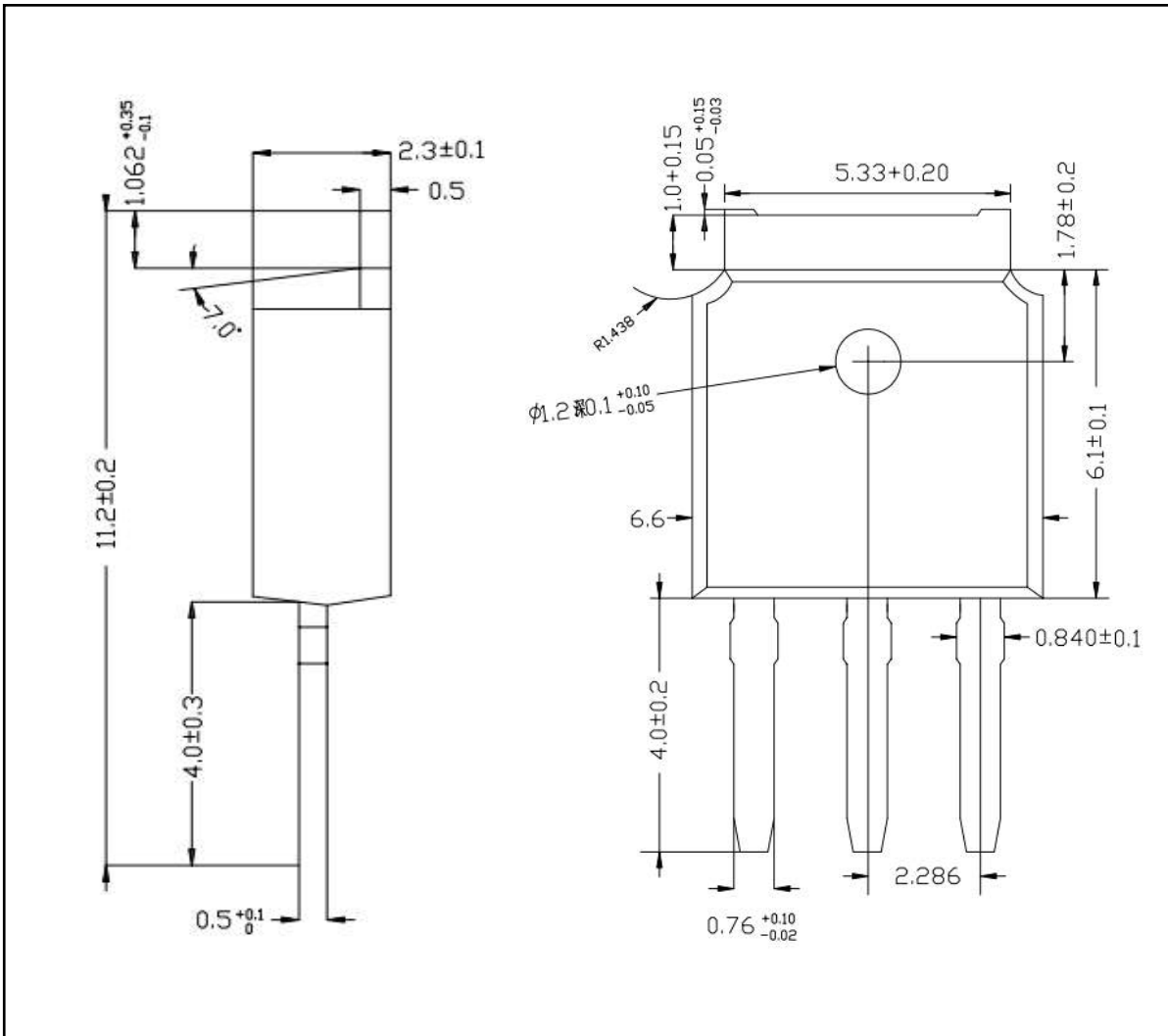

■ TO-252 PACKAGE OUTLINE DIMENSIONS

