

DIO20491

4μA, Rail-to-Rail Input/ Output Low Power Amplifier

Features

- Ultra low power: 4μA
- Unity gain stable
- Gain bandwidth product: 150kHz
- Wide supply range: 1.8V to 5.5V
- Available in SOT23-5, DFN2*2-6 packages
- Temperature range:
 - Industrial: -40°C to 85°C
 - Extended: -40°C to 125°C

Descriptions

DIO20491 is an ultra low power operational amplifier. DIO20491 has a gain-bandwidth product of 150kHz, wide operating supply voltage from 1.8V to 5.5V and broad output voltage swing.

DIO20491 consumes ultra low power, with 4μA bias current, which makes DIO20491 can be ideal for battery powered device, temperature-sense device, etc.

The DIO20491 operational amplifier is available in single configuration. All types of amplifiers are fully specified over the extended -40°C to 125°C temperature range.

Typical Applications

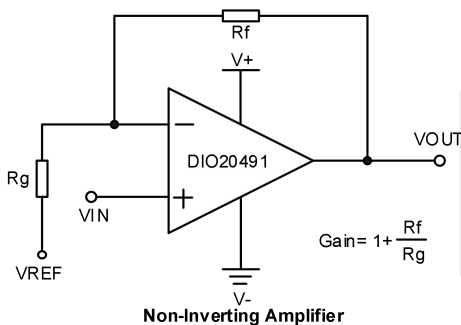

Applications

- Portable Equipment
- Active Filters
- Data Acquisition
- Portable Equipment
- Test Equipment
- Broadband Communication
- Process Control
- Audio and Video Processing

Ordering Information

Order Part Number	Top Marking		T _A	Package	
DIO20491ST5	W921	Green or RoHS	-40°C to 125°C	SOT23-5	Tape & Reel, 3000
DIO20491DN6	DBV4	Green or RoHS	-40°C to 125°C	DFN2*2-6	Tape & Reel, 3000

Pin Assignments

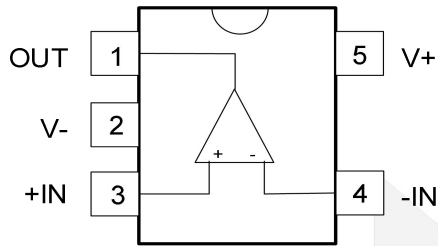

SOT23-5

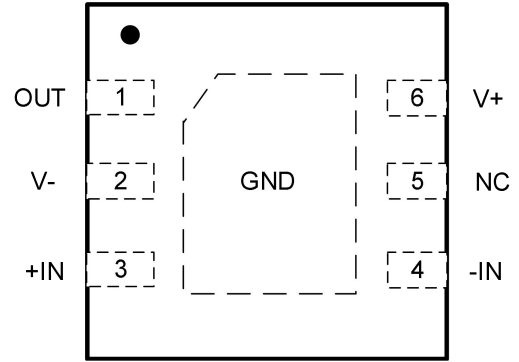

DFN2*2-6

Figure 1 Top View

Pin Description

Pin name	Description
V+	Positive supply
V-	Negative supply
+IN	Positive Input
-IN	Negative Input
OUT	Output
NC	No connect
GND(Exposed Pad)	Ground



Absolute Maximum Ratings

Stresses beyond those listed under “Absolute Maximum Rating” may cause permanent damage to the device. These are stress ratings only and functional operation of the device at these or any other condition beyond those indicated in the operational sections of the specifications is not implied. Exposure to absolute maximum rating conditions for extended periods may affect device reliability.

Parameter		Rating	Unit
Supply Voltage (V+ – V-)		7	V
Input Voltage		(V-)-0.3V to (V+)+0.3V	V
Difference Input Voltage		V+ – V-	V
Storage Temperature Range		-65 to 150	°C
Junction Temperature		150	°C
Lead Temperature Range		260	°C
ESD	HBM, JEDEC: JESD22-A114	8	kV
	CDM, JEDEC: JESD22-C101	2	

Recommended Operating Conditions

The Recommended Operating Conditions table defines the conditions for actual device operation to ensure optimal performance to the datasheet specifications. DIOO does not recommend exceeding them or designing to Absolute Maximum Ratings.

Parameter		Rating	Unit
Supply Voltage		1.8 to 5.5	V
Input Voltage		0 to 5	V
Operating Temperature Range		-40 to 125	°C



Electrical Characteristics

Typical value: $V_+ = 5V$, $R_L = 100k\Omega$ to $V_+/2$, $V_{CM} = 1/2V_+$, $T_A = 25^\circ C$, unless otherwise specified.

Symbol	Parameter	Conditions	Min.	Typ.	Max.	Unit
INPUT CHARACTERISTICS						
V_{OS}	Input Offset Voltage	$-40^\circ C \leq T_A \leq 125^\circ C$, $V_+ = 1.8V$ to $5.5V$	-0.85		0.85	mV
I_B	Input Bias Current	$V_+ = 1.8V$ to $5.5V$		1		pA
I_{OS}	Input Offset Current	$V_+ = 1.8V$ to $5.5V$		1		pA
V_{CM}	Common Mode Voltage Range		-0.1		(V_+) +0.1	V
CMRR	Common Mode Rejection Ratio	$-40^\circ C \leq T_A \leq 125^\circ C$,		130		dB
A_{OL}	Open Loop Voltage Gain	$R_L = 100k\Omega$, $V_O = 0.1$ to $(V_+) - 0.1$	70	105		dB
$\Delta V_{OS}/\Delta T$	Input Offset Voltage Drift	$-40^\circ C \leq T_A \leq 125^\circ C$		± 5		$\mu V/^\circ C$
OUTPUT CHARACTERISTICS						
V_{OH}	Output Voltage High	$R_L = 10k\Omega$, $-40^\circ C \leq T_A \leq 125^\circ C$		4.94		V
V_{OL}	Output Voltage Low	$R_L = 10k\Omega$, $-40^\circ C \leq T_A \leq 125^\circ C$		60		mV
I_{SC}	Output Short Circuit Current	Source I_{SC} , $V_+ = 5V$		24		mA
		Sink I_{SC} , $V_+ = 5V$		24		
POWER SUPPLY						
PSRR	Power Supply Rejection Ration		50			dB
I_Q	Supply Current	$-40^\circ C \leq T_A \leq 125^\circ C$		4		μA
DYNAMIC PERFORMANCE						
GBP	Gain Bandwidth Product	$C_L = 100pF$		150		kHz
SR	Slew Rate	$G = 1$, 2V Output Step		70		V/ms
t_s	Setting Time	$G = 1$, 2V Output Step		20		μs
θ_m	Phase Margin			60		Deg
t_r	Overload Recovery Time			166		μs
NOISE PERFORMANCE						
THD	Total Harmonic Distortion	$f = 100Hz$, $4V_{PP}$, $R_L = 100k\Omega$,		0.09		%
e_n	Voltage Noise Density	$f = 1kHz$		103		nV/\sqrt{Hz}

Specifications subject to change without notice.

Typical Performance Characteristics

Supply Current vs. Supply Voltage

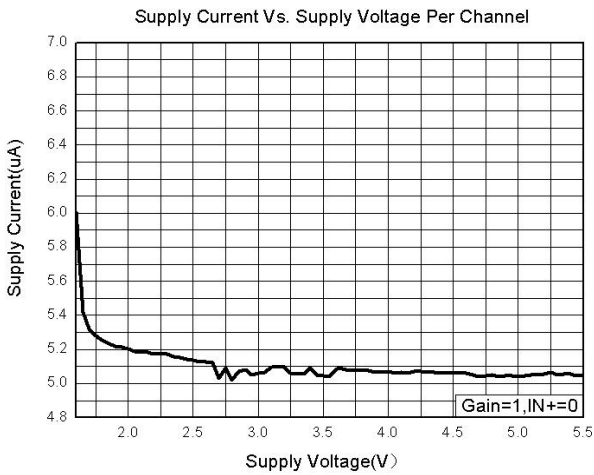

Supply Current vs. Temperature

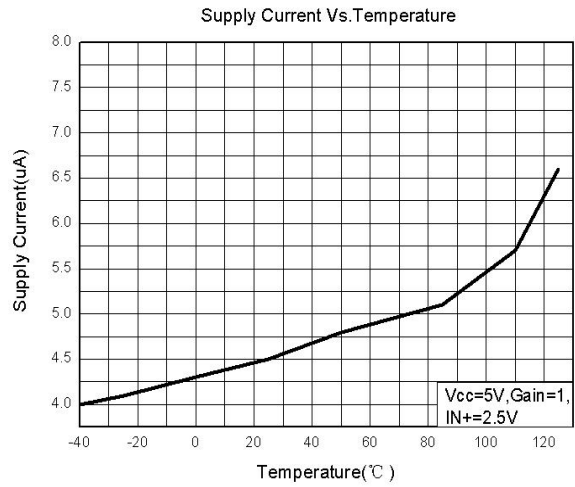

I_{source} vs. Output Voltage

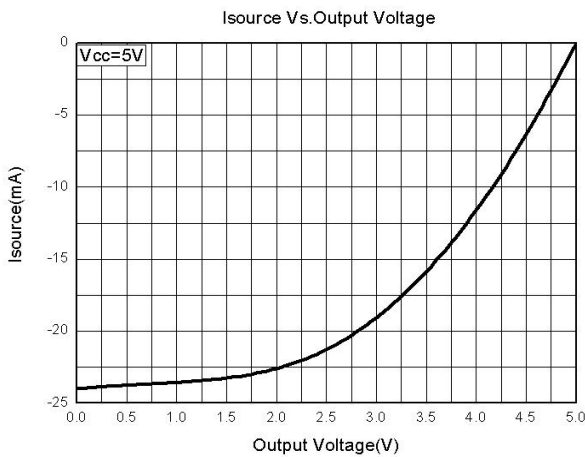

I_{sink} vs. Output Voltage

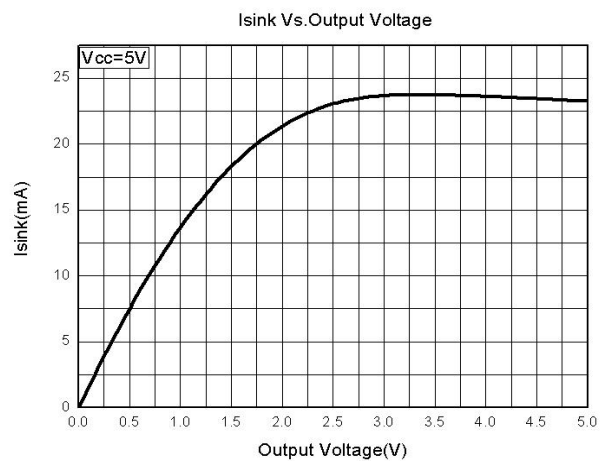

Gain vs. Frequency

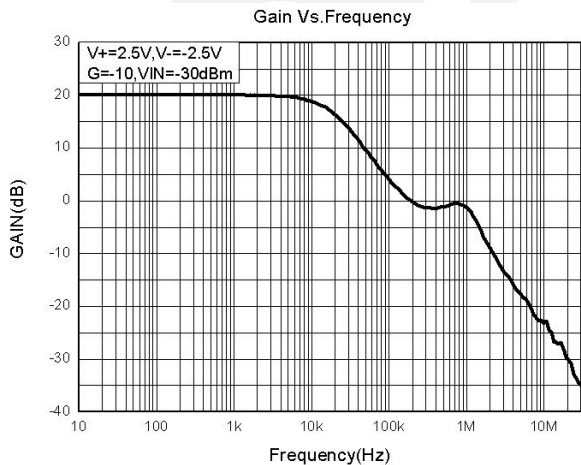

Input Offset Voltage vs. Temperature

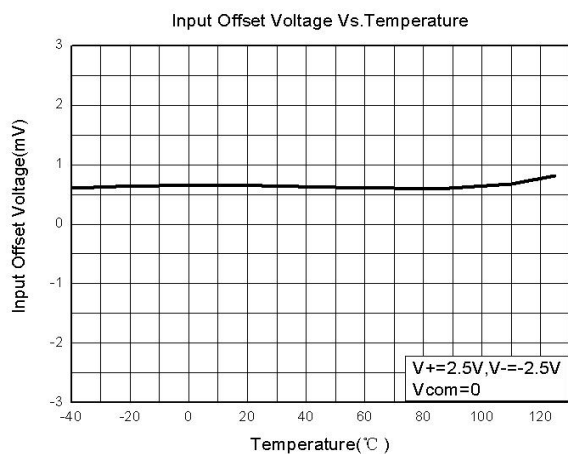

Input Offset Voltage vs. Supply Voltage

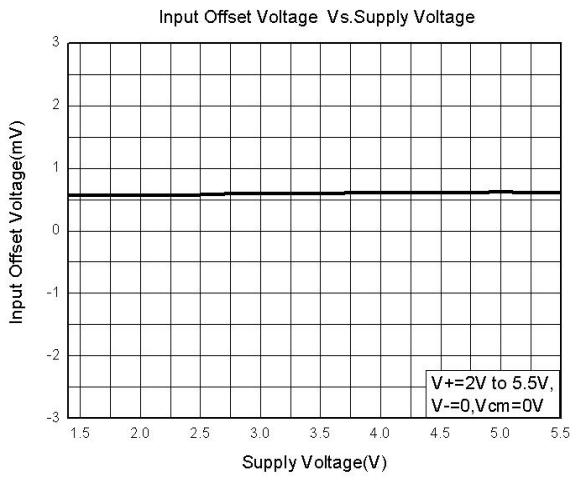

Small-Signal Response (V+=5V, C_L=200pF)

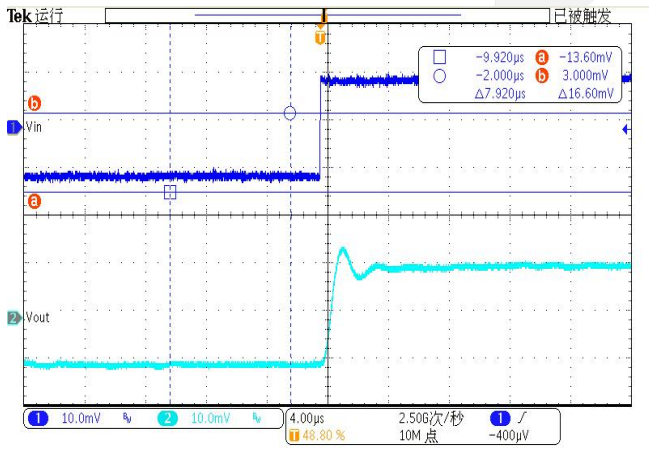

Small-Signal Response (V+=5V, C_L=200pF)

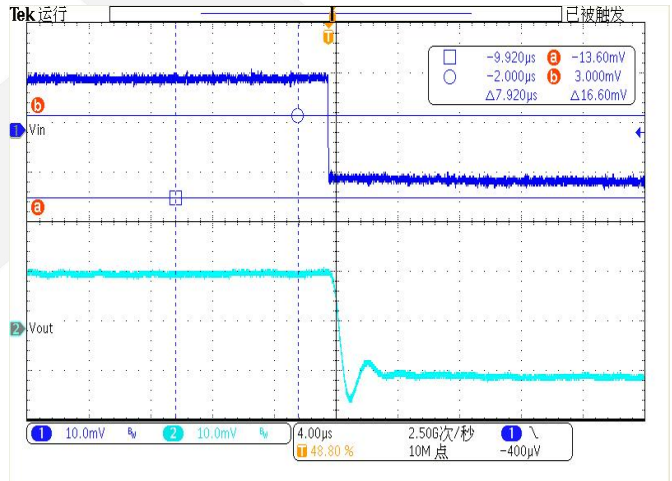

Large-Signal Response (V+=5V, R_L=1MΩ)

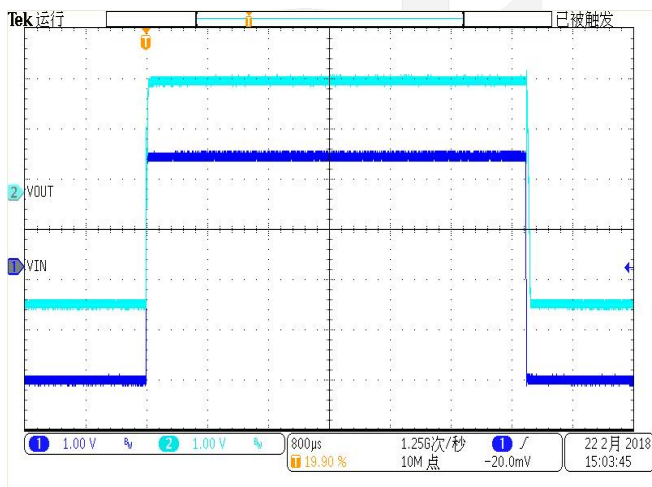

Physical Dimensions: SOT23-5

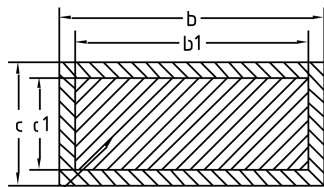
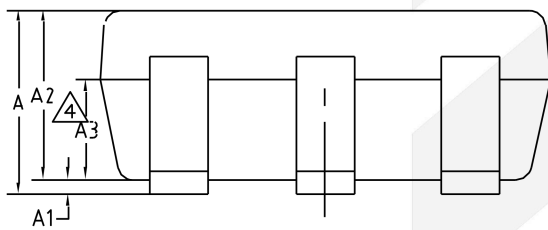
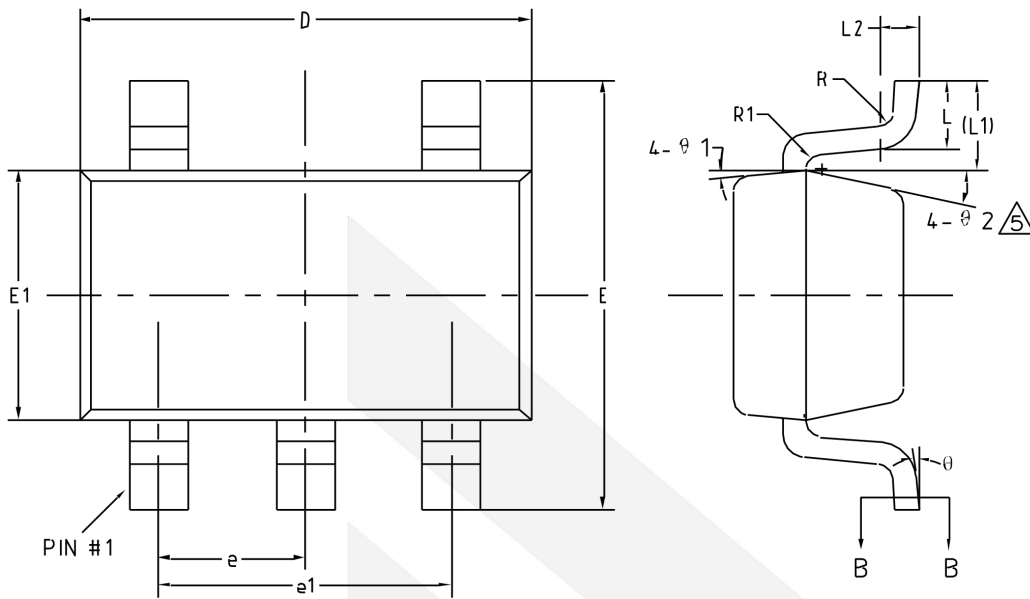

BASE METAL
SECTION B-B

COMMON DIMENSIONS (UNITS OF MEASURE=MILLIMETER)			
Symbol	MIN	NOM	MAX
A	-	-	1.25
A1	0	-	0.15
A2	1.00	1.10	1.20
A3	0.60	0.65	0.70
b	0.36	-	0.50
b1	0.36	0.38	0.45
c	0.14	-	0.20
c1	0.14	0.15	0.16
D	2.826	2.926	3.026
E	2.60	2.80	3.00
E1	1.526	1.626	1.726
e	0.90	0.95	1.00
e1	1.80	1.90	2.00
L	0.35	0.45	0.60
L1	0.59REF		
L2	0.25BSC		
R	0.10	-	-
R1	0.10	-	0.25
θ	0°	-	8°
θ1	3°	5°	7°
θ2	6°	-	14°

Physical Dimensions: DFN2*2-6

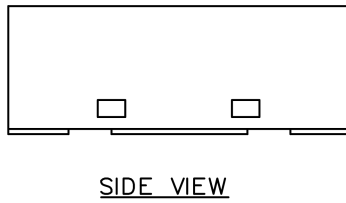
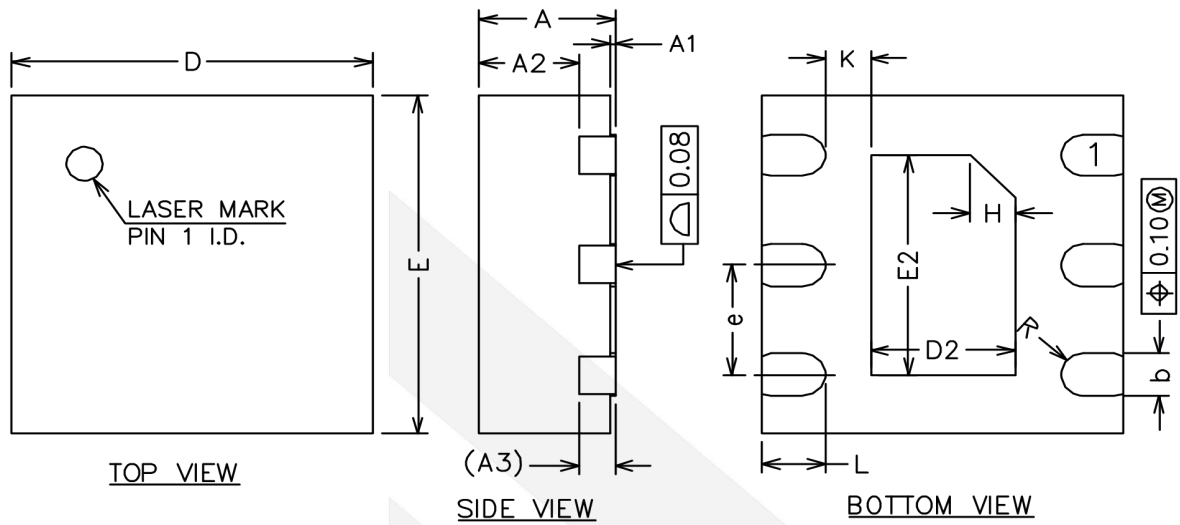

COMMON DIMENSIONS (UNITS OF MEASURE=MILLIMETER)			
Symbol	MIN	NOM	MAX
A	0.70	0.75	0.80
A1	0.00	0.02	0.05
A2	0.50	0.55	0.60
A3	0.20REF		
b	0.20	-	0.35
D	1.90	2.00	2.10
E	1.90	2.00	2.10
D2	0.70	0.80	0.90
E2	1.20	1.40	1.60
e	0.55	0.65	0.75
H	0.20REF		
K	0.20	-	-
L	0.30	0.35	0.40
R	0.11	-	-

CONTACT US

Dioo is a professional design and sales corporation for high-quality and performance analog semiconductors. The company focuses on industry markets, such as, cell phone, handheld products, laptop, and medical equipment and so on. Dioo's product families include analog signal processing and amplifying, LED drivers and charger IC. Go to <http://www.dioo.com> for a complete list of Dioo product families.

For additional product information, or full datasheet, please contact with our Sales Department or Representatives.

