

## 1. 特性

- 宽共模电压范围：0V 至 76V
- 高精度：
  - Gain:
    - Gain error: 0.10% (max)
  - Offset:
    - Offset voltage:  $\pm 8\mu\text{V}$  (typ)
- 可供选择的增益：
  - $G = 10\text{V/V}$  (CSA230-10)
  - $G = 20\text{V/V}$  (CSA230-20)
  - $G = 50\text{V/V}$  (CSA230-50)
  - $G = 100\text{V/V}$  (CSA230-100)
- SOT23-5 封装

## 2. 应用

- 通信设备
- 功率管理系统
- 服务器
- 工业自动化与控制
- 电池电流检测

## 3. 说明

CSA230 是一款双向高精度电流采样放大器。具有小于  $8\mu\text{V}$  (typ) 的失调电压，和小于 0.1% (max) 的增益误差。

CSA230 的 0V 至 76V 的宽输入共模范围，和 90kHz 的带宽使其非常适合驱动各种 ADC，在多通道数据采集系统中。

CSA230 的温度工作范围是  $-40^\circ\text{C}$  到  $125^\circ\text{C}$ 。有关订购信息，请参见 Table 1。

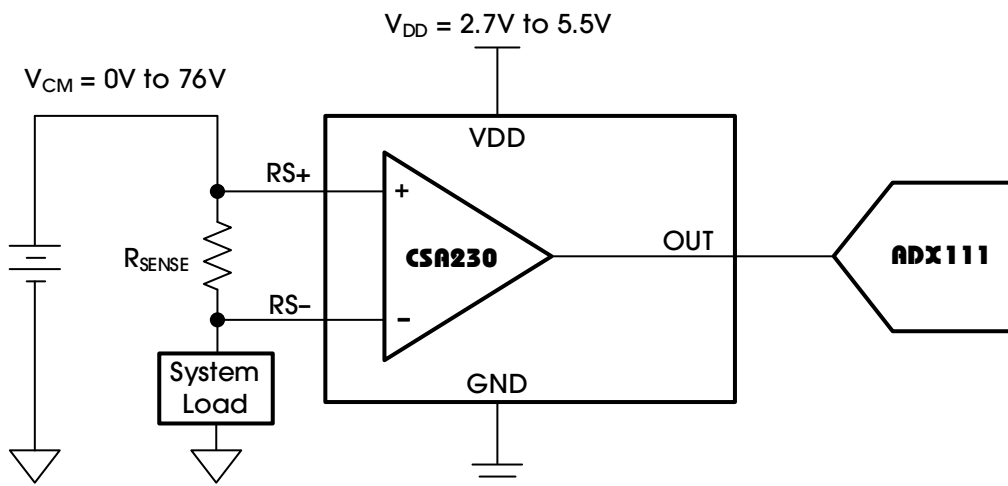

Table 1 lists the order information.

**Table 1. Order Information**

ORDER NUMBER <sup>(1)</sup>	PART NUMBER	CH (#)	PKG.	BIDIRECTIONAL	MARK	GAIN (TYP) (V/V)	GBW (kHz)	RATING	OP. TEMP (°C)	PKG. OPTION
CSA230LASOT235 <sup>(2)</sup>	CSA230-10	1	SOT23-5	No	CSA230LA	10	90	Industrial	-40-125	T/R-3000
CSA230MASOT235	CSA230-20	1	SOT23-5	No	CSA230MA	20	90	Industrial	-40-125	T/R-3000
CSA230NASOT235	CSA230-50	1	SOT23-5	No	CSA230NA	50	90	Industrial	-40-125	T/R-3000
CSA230PASOT235 <sup>(2)</sup>	CSA230-100	1	SOT23-5	No	CSA230PA	100	90	Industrial	-40-125	T/R-3000

**Table 2. Family Selection Guide**

ORDER NUMBER <sup>(1)</sup>	PART NUMBER	CH (#)	PKG.	BIDIRECTIONAL	MARK	GAIN (TYP) (V/V)	GBW (kHz)	RATING	OP. TEMP (°C)	PKG. OPTION
CSA220LASOT235 <sup>(2)</sup>	CSA220-10	1	SOT23-5	No	CSA220LA	10	50	Industrial	-40-125	T/R-3000
CSA220MASOT235	CSA220-20	1	SOT23-5	No	CSA220MA	20	50	Industrial	-40-125	T/R-3000
CSA220NASOT235	CSA220-50	1	SOT23-5	No	CSA220NA	50	50	Industrial	-40-125	T/R-3000
CSA220PASOT235	CSA220-100	1	SOT23-5	No	CSA220PA	100	50	Industrial	-40-125	T/R-3000
CSA221LASOIC8 <sup>(2)</sup>	CSA221-10	1	SOIC-8	Yes	CSA221LA	10	50	Industrial	-40-125	T/R-4000
CSA221MASOIC8	CSA221-20	1	SOIC-8	Yes	CSA221MA	20	50	Industrial	-40-125	T/R-4000
CSA221NASOIC8	CSA221-50	1	SOIC-8	Yes	CSA221NA	50	50	Industrial	-40-125	T/R-4000
CSA221PASOIC8 <sup>(2)</sup>	CSA221-100	1	SOIC-8	Yes	CSA221PA	100	50	Industrial	-40-125	T/R-4000
CSA221LATSSOP8 <sup>(2)</sup>	CSA221-10	1	TSSOP-8	Yes	CSA221LA	10	50	Industrial	-40-125	T/R-4000
CSA221MATSSOP8	CSA221-20	1	TSSOP-8	Yes	CSA221MA	20	50	Industrial	-40-125	T/R-4000
CSA221NATSSOP8	CSA221-50	1	TSSOP-8	Yes	CSA221NA	50	50	Industrial	-40-125	T/R-4000
CSA221PATSSOP8 <sup>(2)</sup>	CSA221-100	1	TSSOP-8	Yes	CSA221PA	100	50	Industrial	-40-125	T/R-4000
CSA231LASOIC8	CSA231-10	1	SOIC-8	Yes	CSA231LA	10	90	Industrial	-40-125	T/R-4000
CSA231MASOIC8	CSA231-20	1	SOIC-8	Yes	CSA231MA	20	90	Industrial	-40-125	T/R-4000
CSA231NASOIC8	CSA231-50	1	SOIC-8	Yes	CSA231NA	50	90	Industrial	-40-125	T/R-4000
CSA231PASOIC8 <sup>(2)</sup>	CSA231-100	1	SOIC-8	Yes	CSA231PA	100	90	Industrial	-40-125	T/R-4000
CSA231LATSSOP8 <sup>(2)</sup>	CSA231-10	1	TSSOP-8	Yes	CSA231LA	10	90	Industrial	-40-125	T/R-4000
CSA231MATSSOP8	CSA231-20	1	TSSOP-8	Yes	CSA231MA	20	90	Industrial	-40-125	T/R-4000
CSA231NATSSOP8	CSA231-50	1	TSSOP-8	Yes	CSA231NA	50	90	Industrial	-40-125	T/R-4000
CSA231PATSSOP8 <sup>(2)</sup>	CSA231-100	1	TSSOP-8	Yes	CSA231PA	100	90	Industrial	-40-125	T/R-4000

Devices can be ordered via the following two ways:

1. Place orders directly on our website ([www.analogsemi.com](http://www.analogsemi.com)), or;
2. Contact our sales team by mailing to [sales@analogsemi.com](mailto:sales@analogsemi.com).

Note 1:

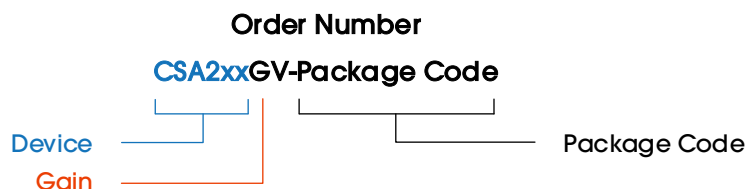

Note 2: Available in the future.

## 4. PIN CONFIGURATION AND FUNCTIONS

Figure 1 illustrates the pin configuration.

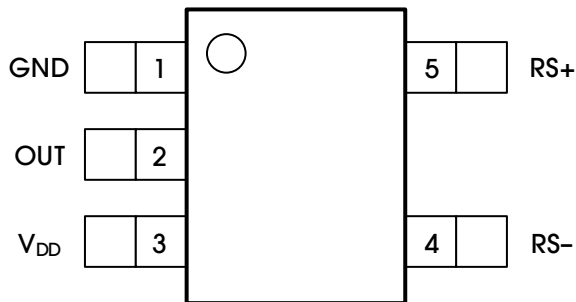

Figure 1. Pin Configuration

Table 3 lists the pin functions.

Table 3. Pin Functions

POSITION	NAME	TYPE	DESCRIPTION
1	GND	Power	Ground
2	OUT	Output	Output
3	V <sub>DD</sub>	Power	Supply voltage, connecting at least 100nF capacitor to GND.
4	RS-	Input	External resistor load-side connection
5	RS+	Input	External resistor power-side connection

## 5. SPECIFICATIONS

### 5.1 ABSOLUTE MAXIMUM RATINGS

Table 4 lists the absolute maximum ratings of the CSA230.

Table 4. Absolute Maximum Ratings

PARAMETER	DESCRIPTION	MIN	MAX	UNITS
Voltage	V <sub>DD</sub> to GND	-0.3	6.0	V
	RS+, RS- to GND	-0.3	80	
	REF1, REF2 to GND	-0.3	V <sub>DD</sub> + 0,3	
	RS+ to RS-	1s maximum duration due to package thermal dissipation		
Current	Continuous input current (any pin)	-20	20	mA
Temperature	Operating, T <sub>A</sub>	-40	125	°C
	Junction, T <sub>J</sub>		150	
	Storage, T <sub>stg</sub>	-65	150	
	Lead (soldering, 10s)		300	
	Soldering (reflow)		260	

Note: Stresses beyond those listed under Table 4 may cause permanent damage to the device. These are stress ratings only, which do not imply functional operation of the device at these or any other conditions beyond those indicated under Table 6. Exposure to absolute-maximum-rated conditions for extended periods may affect device reliability.

### 5.2 ESD RATINGS

Table 5 lists the ESD ratings of the CSA230.

Table 5. ESD Ratings

PARAMETER	SYMBOL	DESCRIPTION	VALUE	UNITS
Electrostatic Discharge	V <sub>(ESD)</sub>	Human-body model (HBM), per ANSI/ESDA/JEDEC JS-001 <sup>(1)</sup>	±6000	V
		Charged-device model (CDM), per JEDEC specification JESD22-C101 <sup>(2)</sup>	±1500	

Note 1: The JEDEC document JEP155 indicates that 500V HBM allows safe manufacturing with a standard ESD control process.

Note 2: The JEDEC document JEP157 indicates that 250V CDM allows safe manufacturing with a standard ESD control process.

## 5.3 RECOMMENDED OPERATING CONDITIONS

Table 6 lists the recommended operating conditions for the CSA230.

Table 6. Recommended Operating Conditions

PARAMETER	SYMBOL	MIN	NOM	MAX	UNITS
<b>POWER SUPPLY</b>					
Power Supply, $V_{DD}$ to GND		2.7	3.3	5.5	V
<b>ANALOG INPUTS</b>					
Input Voltage Range, (RS+) - (RS-)	$V_{IN}$		$V_{OH}$ / Gain		V
Input Voltage to GND		0		76	V
<b>TEMPERATURE RANGE</b>					
Operating Ambient Temperature	$T_A$	-40		125	°C

## 5.4 THERMAL INFORMATION

Table 7 lists the thermal information for the CSA230.

Table 7. Thermal Information

PARAMETER	SYMBOL	SOT23-5	UNITS
Junction-to-Ambient Thermal Resistance	$R_{\theta JA}$	168	°C/W
Junction-to-Board Thermal Resistance	$R_{\theta JB}$	39	°C/W
Junction-to-Top Characterization Parameter	$\psi_{JT}$	10	°C/W
Junction-to-Board Characterization Parameter	$\psi_{JB}$	36	°C/W
Junction-to-Case (Top) Thermal Resistance	$R_{\theta JC(top)}$	103	°C/W
Junction-to-Case (Bottom) Thermal Resistance	$R_{\theta JC(bot)}$	66	°C/W

## 5.5 ELECTRICAL CHARACTERISTICS

Table 8 lists the electrical characteristics of the CSA230.  $V_{RS+} = V_{RS-} = 76V$ ,  $V_{DD} = 3.3V$ ,  $V_{SENSE} = V_{RS+} - V_{RS-} = 1mV$ ,  $T_A = -40^{\circ}C$  to  $125^{\circ}C$ , unless otherwise noted. Typical values are at  $T_A = 25^{\circ}C$ <sup>(1)</sup>.

Table 8. Electrical Characteristics

PARAMETER	SYMBOL	CONDITIONS	MIN	TYP	MAX	UNITS
<b>DC CHARACTERISTICS</b>						
Supply Voltage	$V_{DD}$	Guaranteed by PSRR	2.7		5.5	V
Supply Current	$I_{DD}$	$T_A = 25^{\circ}C$		560	800	$\mu A$
		$-40^{\circ}C < T_A < 125^{\circ}C$			850	
Power-Supply Rejection Ratio	PSRR	$2.7V \leq V_{DD} \leq 5.5V$	105	108		dB
Input Common-Mode Voltage Range	$V_{CM}$	Guaranteed by CMRR	0		76	V
Input Bias Current at $V_{RS+}$ and $V_{RS-}$ <sup>(2)</sup>	$I_{RS+}, I_{RS-}$			0.003	0.1	$\mu A$
Input Offset Current <sup>(2)</sup>	$I_{RS+} - I_{RS-}$				0.2	$\mu A$
Input Leakage Current <sup>(2)</sup>	$I_{RS+}, I_{RS-}$	$V_{DD} = 0V, V_{RS+} = V_{RS-} = 76V$			0.2	$\mu A$
Common-Mode Rejection Ratio	CMRR	$0V < V_{RS+} < 76V$	130	159		dB
Input Offset Voltage <sup>(3)</sup>	$V_{OS}$	$T_A = 25^{\circ}C$		$\pm 8$	$\pm 60$	$\mu V$
		$-40^{\circ}C \leq T_A \leq 125^{\circ}C$		$\pm 50$	$\pm 150$	
Input Offset Voltage Drift <sup>(2)</sup>	$TCV_{OS}$			160		nV/ $^{\circ}C$
Input Sense Voltage	$V_{SENSE}$			$V_{OH} / G$		mV
Gain <sup>(3)</sup>	G	CSA230-10		10		V/V
		CSA230-20		20		
		CSA230-50		50		
		CSA230-100		100		
Gain Error <sup>(2)</sup>	GE	$T_A = 25^{\circ}C$		0.02	0.1	%
		$-40^{\circ}C \leq T_A \leq 85^{\circ}C$			0.25	
		$-40^{\circ}C \leq T_A \leq 125^{\circ}C$			0.3	
Output Low Voltage	$V_{OL}$	Sink 500 $\mu A$			15	mV
		No load			4	
Output High Voltage	$V_{OH}$	Source 500 $\mu A$	$V_{DD} - 0.015$			V
<b>AC CHARACTERISTICS</b>						
Signal Bandwidth	BW -3dB	All gain configurations $V_{SENSE} > 5mV$		90		kHz
Slew Rate	SR			0.4		V/ $\mu s$
AC Power-Supply Rejection Ratio	AC PSRR	$f = 200kHz$		47		dB
AC CMRR	AC CMRR	$f = 200kHz$		90		dB
Capacitive Load Stability	$C_{LOAD}$	With 250 $\Omega$ isolation resistor		20		nF
		Without any isolation resistor		500		pF
Input Voltage-Noise Density	$e_n$	$f = 1kHz$		70		nV/ $\sqrt{Hz}$
Power-Up Time <sup>(4)</sup>				80		$\mu s$
Saturation Recovery Time				5		$\mu s$

Note 1: All devices are 100% production tested at  $T_A = 25^{\circ}C$ . All temperature limits are guaranteed by design.

Note 2: Specifications are guaranteed by design, not production tested.

Note 3: Gain and offset voltage are calculated based on two-point measurements:  $V_{SENSE1}$  and  $V_{SENSE2}$ .

$$V_{SENSE1} = 20\% \times \text{Full-Scale } V_{SENSE}, V_{SENSE2} = 80\% \times \text{Full-Scale } V_{SENSE}.$$

Note 4: Output is high-Z during power-up.

## 6. TYPICAL CHARACTERISTICS

$V_{RS+} = V_{RS-} = 76V$ ,  $V_{DD} = 3.3V$ ,  $V_{SENSE} = V_{RS+} - V_{RS-} = 1mV$ ,  $T_A = 25^{\circ}C$ , unless otherwise noted.

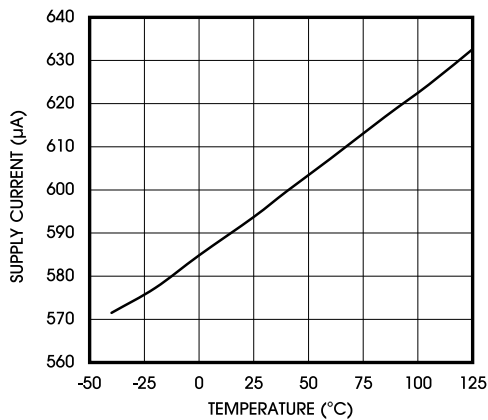

Figure 2. Supply Current vs. Temperature

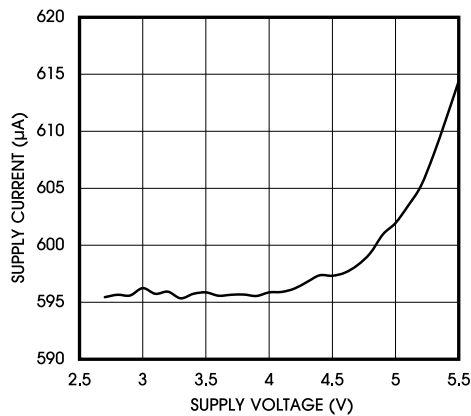

Figure 3. Supply Current vs. Supply Voltage

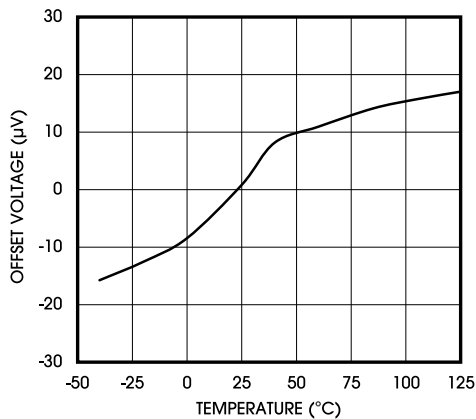

Figure 4. Input Offset Voltage vs. Temperature

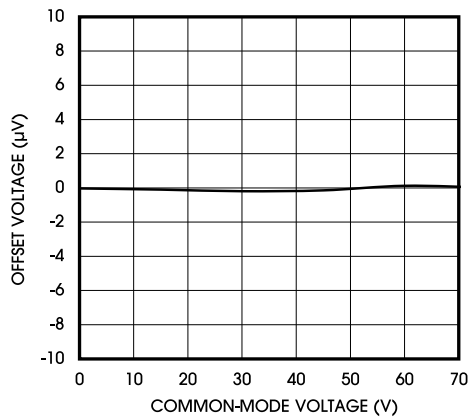

Figure 5. Input Offset Voltage vs. Input Common Mode Voltage

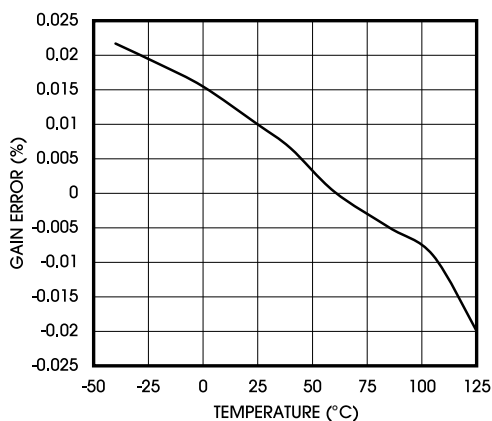

Figure 6. Gain Error vs. Temperature

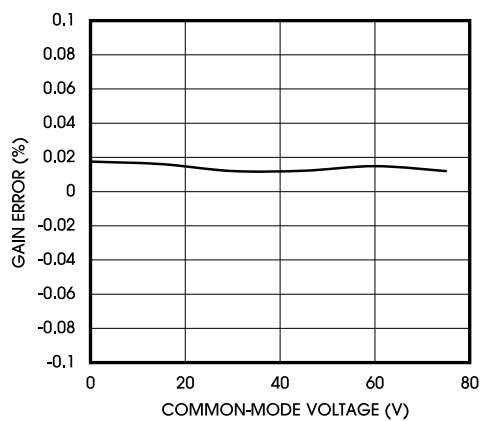

Figure 7. Gain Error vs. Common Mode Voltage

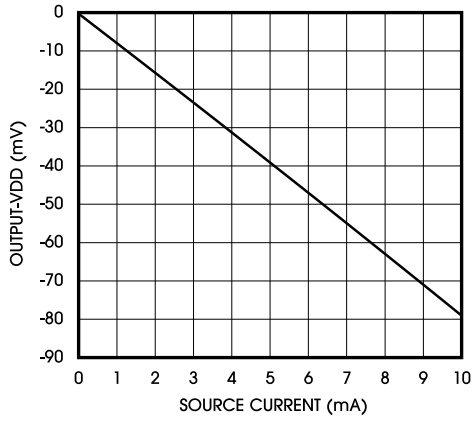

Figure 8.  $V_{OH}$  vs. Source Current

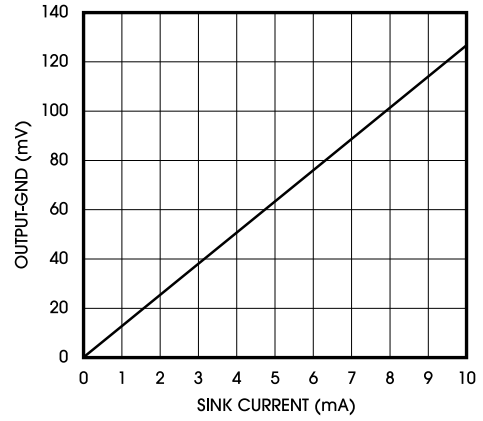

Figure 9.  $V_{OL}$  vs. Sink Current

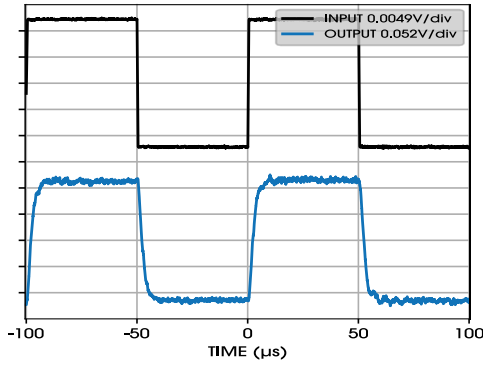

Figure 10. Small Signal Step Response (Gain = 10)

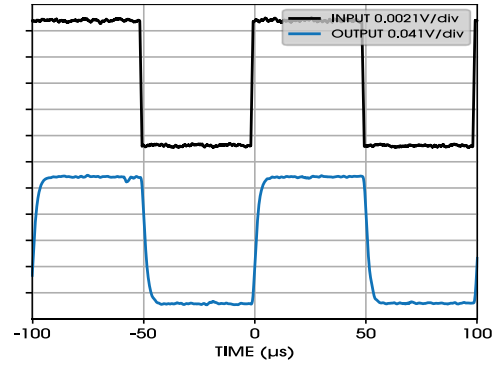

Figure 11. Small Signal Step Response (Gain = 20)

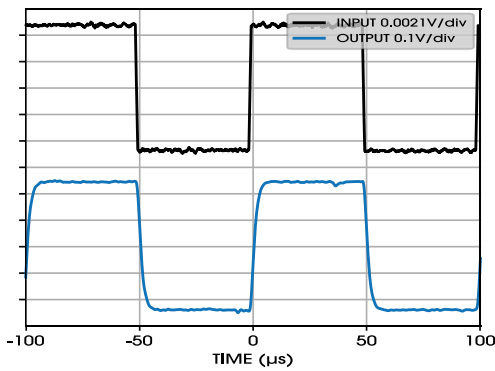

Figure 12. Small Signal Step Response (Gain = 50)

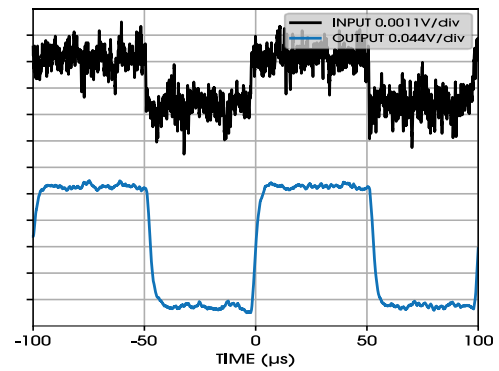

Figure 13. Small Signal Step Response (Gain = 100)



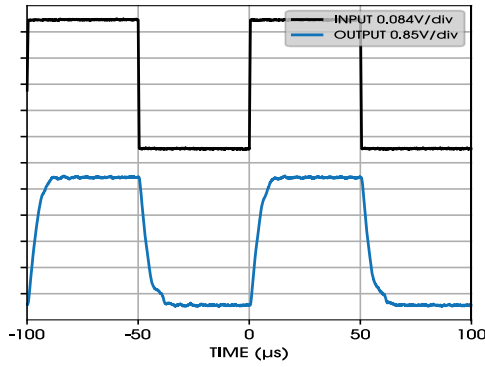

Figure 14. Large Signal Step Response (Gain = 10)

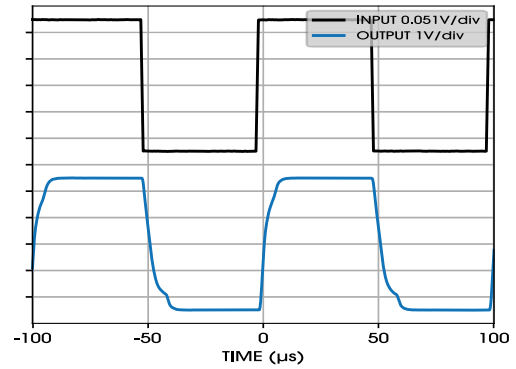

Figure 15. Large Signal Step Response (Gain = 20)

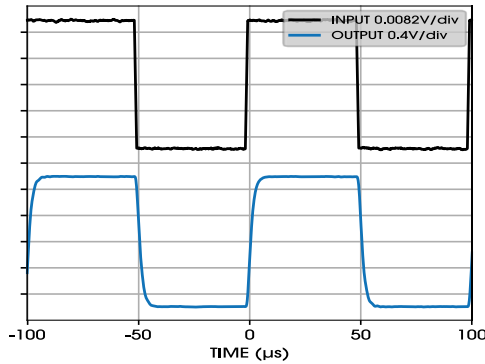

Figure 16. Large Signal Step Response (Gain = 50)

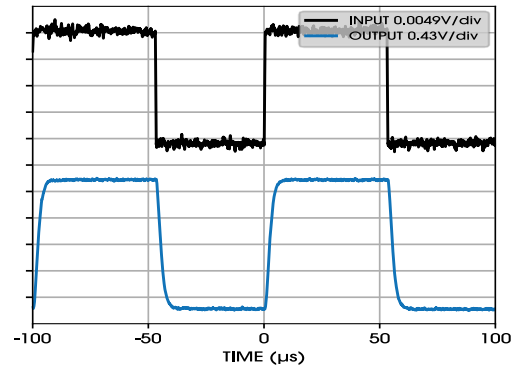

Figure 17. Large Signal Step Response (Gain = 100)

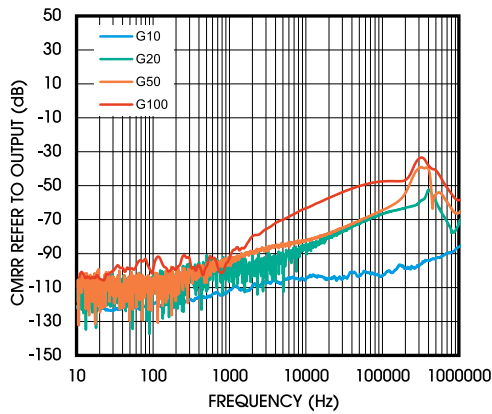

Figure 18. CMRR Referred to Output vs. Frequency

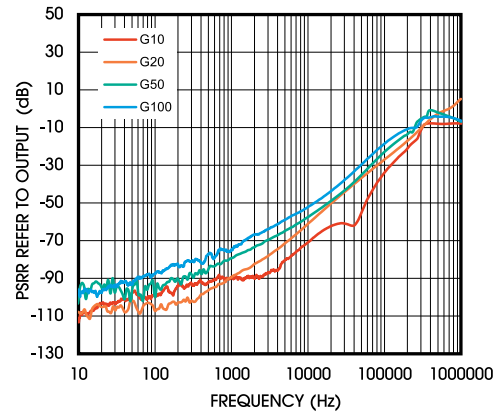

Figure 19. PSRR Referred to Output vs. Frequency

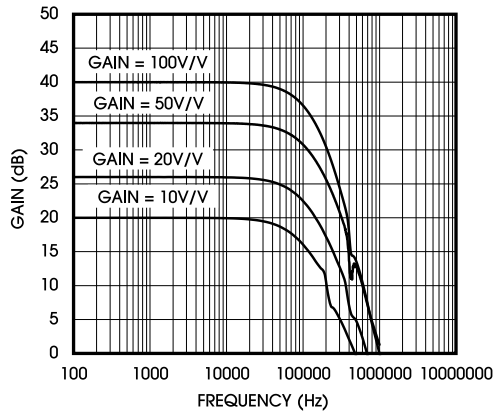

Figure 20. Gain vs frequency

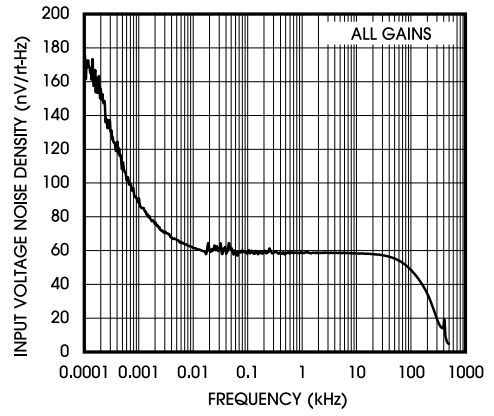

Figure 21. Input Voltage Noise Density vs. Frequency

## 7. 详细说明

### 7.1 概述

CSA230 电流检测放大器具有 0V 至 76V 输入共模范围，与电源电压无关。此功能允许监控低至 0V 的电池电流，并在高于电源电压( $V_{DD}$ )的电压下实现高侧电流检测。CSA230 监控分流器的电流并放大电阻器两端的电压。

高侧电流监控不会干扰被测负载的接地路径，这使得 CSA230 在范围广泛的高压系统中特别有用。

### 7.2 功能模块框图

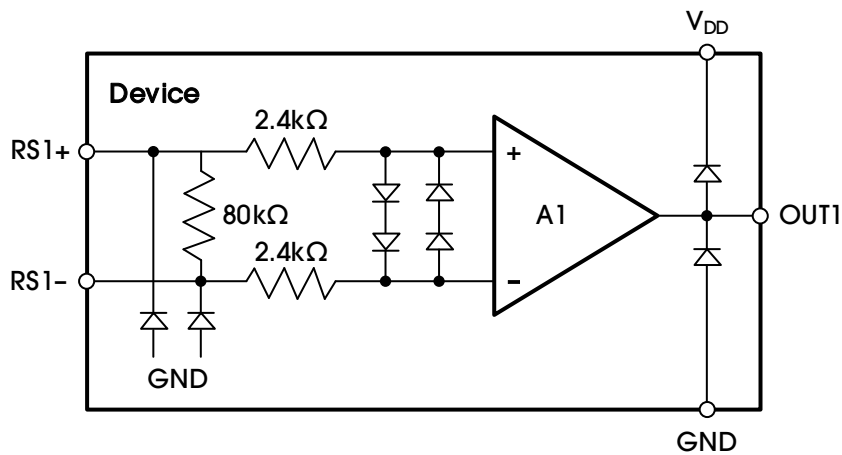

Figure 22. Functional Block Diagram

## 8. 应用和实现

### 注

以下应用部分中的信息不是 AnaloglySemi 组件规范的一部分，AnaloglySemi 不保证其准确性或完整性。AnaloglySemi 的客户有责任确定组件是否适合他们的用途。客户应验证和测试他们的设计实施以确认系统功能。

### 8.1 应用信息

#### 8.1.1 推荐的元件值

理想情况下，最大负载电流会在分流器上产生满量程检测电压。使用典型的 3.3V 为  $V_{DD}$  供电，并选择产生应用所需的最大输出电压所需的增益：

$$V_{OUT} = V_{SENSE} \times A_V \quad (1)$$

其中  $V_{SENSE}$  为满量程感应电压，增益 10V/V 时为 330mV，增益为 20V/V 时为 165mV，增益为 50V/V 时为 66mV，增益为 100V/V 时为 33mV， $A_V$  为器件增益。

在监测高电流的应用中，确保  $R_{SENSE}$  能够耗散其自身的  $I^2R$  损耗。如果分流器的功耗超过标称值，则其值可能会漂移或完全失效。CSA230 可通过不同的分流器电阻值检测各种电流。

#### 8.1.2 选择检测电阻

根据以下标准选择  $R_{SENSE}$ ：

- 电压损失：高  $R_{SENSE}$  值会导致电源电压因 IR 损失而降低。为使电压损失最小，请使用最低的  $R_{SENSE}$  值。
- 精度：较高的  $R_{SENSE}$  值允许更精确地测量较低的电流。这是因为当感测电压较大时偏移变得不那么重要。为获得最佳性能，在  $V_{DD}$  使用 3.3V 时，选择  $R_{SENSE}$  以提供大约 330mV (10V/V 增益)、165mV (20V/V 增益) 或 66mV (50V/V 增益)、33mV (100V/V 增益) 检测电压的满量程电流在每个应用程序。
- 效率和功耗：在高电流水平下， $R_{SENSE}$  中的  $I^2R$  损耗可能很大。选择电阻值及其额定功率耗散(瓦数)时请考虑这一点。此外，如果过热，检测电阻的值可能会漂移。
- 电感：如果  $I_{SENSE}$  具有较大的高频分量，则保持低电感。绕线电阻的电感量最大，而金属膜电阻稍好一些。也可提供低电感金属膜电阻器。它们不是像金属膜或线绕电阻器那样螺旋缠绕在磁芯上，而是一条直的金属带，可提供低于 1Ω 的值。

注意消除寄生走线电阻，避免因流过  $R_{SENSE}$  的大电流导致检测电压出现误差。使用四端电流检测电阻器或使用开尔文(强制和检测) PCB 布局技术。

### 8.2 电源旁路

建议使用电源旁路电容器以获得最佳性能，并且应尽可能靠近设备的电源和接地端子放置。该电源旁路电容器的典型值为靠近  $V_{DD}/GND$  引脚的 0.1μF (NP0/COG 型)。电容器的额定值应至少为最大预期施加电压的两倍。具有嘈杂或高阻抗电源的应用可能需要额外的去耦电容器来抑制电源噪声。

## 9. PACKAGE INFORMATION

The CSA230 is available in the SOT23-5 package. Figure 23 shows the package view.

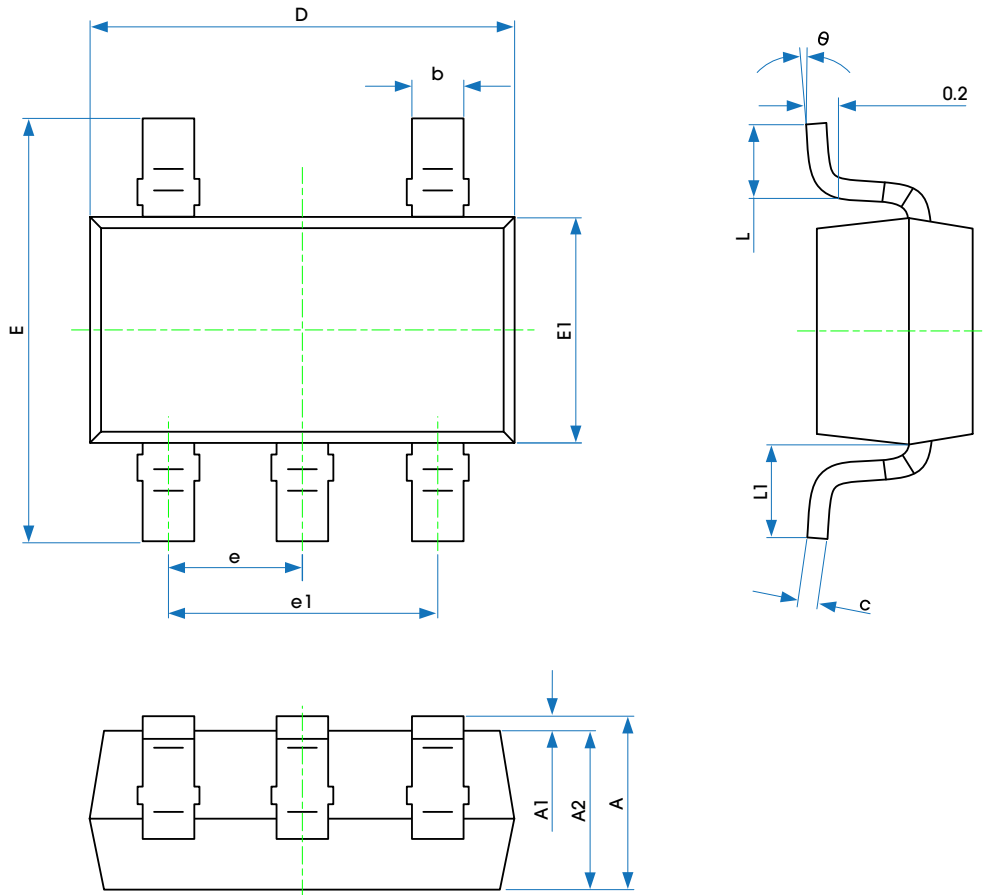

Figure 23. Package View

Table 9 provides detailed information about the dimensions of the package.

Table 9. Dimensions of the Package

SYMBOL	DIMENSIONS IN MILLIMETERS		DIMENSIONS IN INCHES	
	MIN	MAX	MIN	MAX
A	1.050	1.250	0.041	0.049
A1	0.000	0.100	0.000	0.004
A2	1.050	1.150	0.041	0.045
b	0.300	0.500	0.012	0.020
c	0.100	0.200	0.004	0.008
D	2.820	3.020	0.111	0.119
E	2.650	2.950	0.104	0.116
E1	1.500	1.700	0.059	0.067
e	0.950 (BSC)		0.037 (BSC)	
e1	1.800	2.000	0.071	0.079
L	0.300	0.600	0.012	0.024
L1	0.600 REF.		0.024 REF.	
θ	0°	8°	0°	8°

# 10. TAPE AND REEL INFORMATION

Figure 24 illustrates the carrier tape.

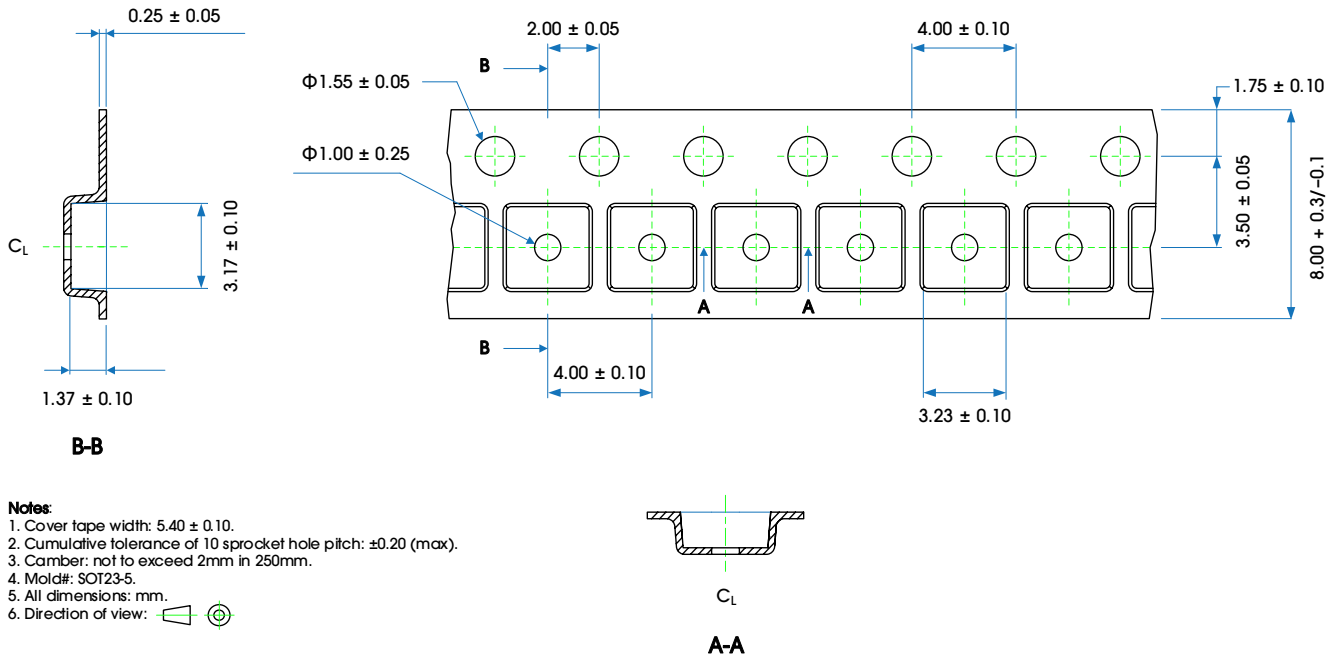

Figure 24. Carrier Tape Drawing

Table 10 provides information about tape and reel.

Table 10. Tape and Reel Information

PACKAGE TYPE	REEL	QTY/REEL	REEL/ INNER BOX	INNER BOX/ CARTON	QTY/CARTON	INNER BOX SIZE (MM)	CARTON SIZE (MM)
SOT23-5	7"	3000	1	20	60000	240*20*265	455*275*255

Figure 25 shows the product loading orientation—pin 1 is assigned at Q3.

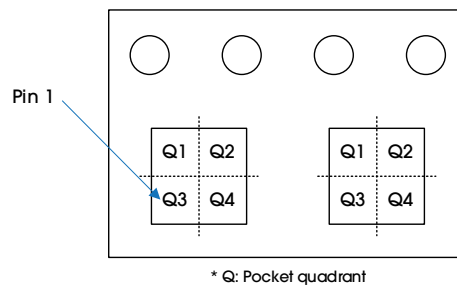

Figure 25. Product Loading Orientation

## REVISION HISTORY

REVISION	DATE	DESCRIPTION
Rev A	01 March 2023	Rev A release.