

1N5817FL THRU 1N5819FL

SURFACE MOUNT SCHOTTKY BARRIER RECTIFIERS

Forward Current-1.0A

Reverse Voltage-20V to 40V

FEATURES

- ◆ For surface mount applications
- ◆ High forward surge current capability
- ◆ Low power loss,high efficiency
- ◆ Metal silicon junction,majority carriers conduction

MECHANICAL DATA

- ◆ Case: SOD-123FL molded plastic body
- ◆ Terminals: Solderable per MIL-STD-750 , Method 2026
- ◆ Weight: Approximated 0.015 grams

PINNING

PIN	DESCRIPTION
1	Cathode
2	Anode

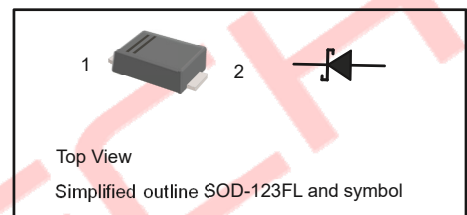

MAXIMUM RATINGS AND ELECTRICAL CHARACTERISTICS

Ratings at 25°C ambient temperature unless otherwise specified.

Single phase half-wave 60 Hz, resistive or inductive load, for capacitive load current derating by 20 %.

PARAMETER	SYMBOL	1N5817FL	1N5818FL	1N5819FL	UNIT
Maximum Repetitive Peak Reverse Voltage	V_{RRM}	20	30	40	V
Maximum RMS Voltage	V_{RMS}	14	21	28	V
Maximum DC Blocking Voltage	V_{DC}	20	30	40	V
Maximum Average Forward Rectified Current at $T_C=75^\circ\text{C}$	$I_{F(AV)}$	1.0			A
Peak Forward Surge Current (Note1)	I_{FSM}	25			A
Maximum Forward Voltage at 1.0 A 3.0 A	V_F	0.45 0.75	0.55 0.875	0.6 0.9	V
Maximum DC Reverse Current at Rated DC Blocking Voltage at $T_A=25^\circ\text{C}$ $T_A=100^\circ\text{C}$	I_R	1 10			mA
Typical Junction Capacitance (Note2)	C_J	110			pF
Operating and Storage Temperature Range	T_J, T_{STG}	-55 to +150			°C

Notes: 1. Measured at 8.3 ms single half sine wave superimposed on rated load (JEDEC Method).

2. Measured at 1MHz and applied reverse voltage of 4 V D.C.

1N5817FL THRU 1N5819FL

RATINGS AND CHARACTERISTIC CURVES

Fig.1 Forward Current Derating Curve

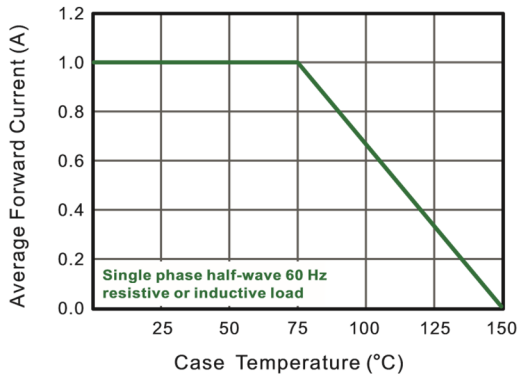

Fig.2 Typical Reverse Characteristics

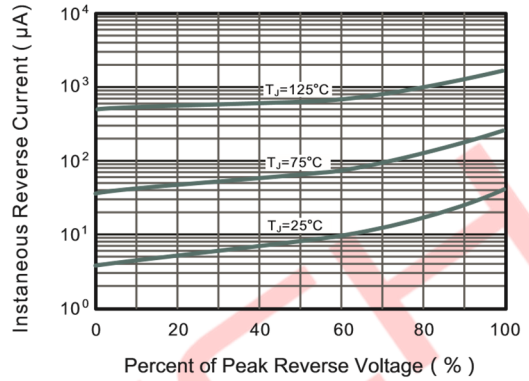

Fig.3 Typical Forward Characteristic

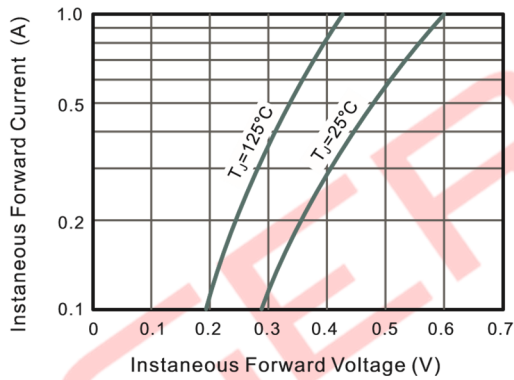

Fig.4 Typical Junction Capacitance

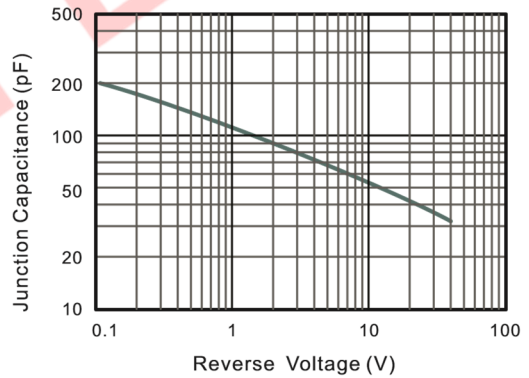
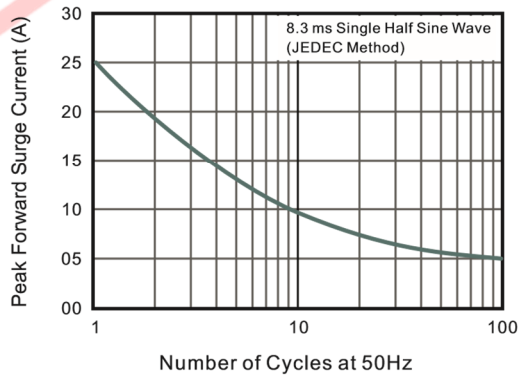

Fig.5 Maximum Non-Repetitive Peak Forward Surge Current



1N5817FL THRU 1N5819FL

PACKAGE OUTLINE

SOD-123FL

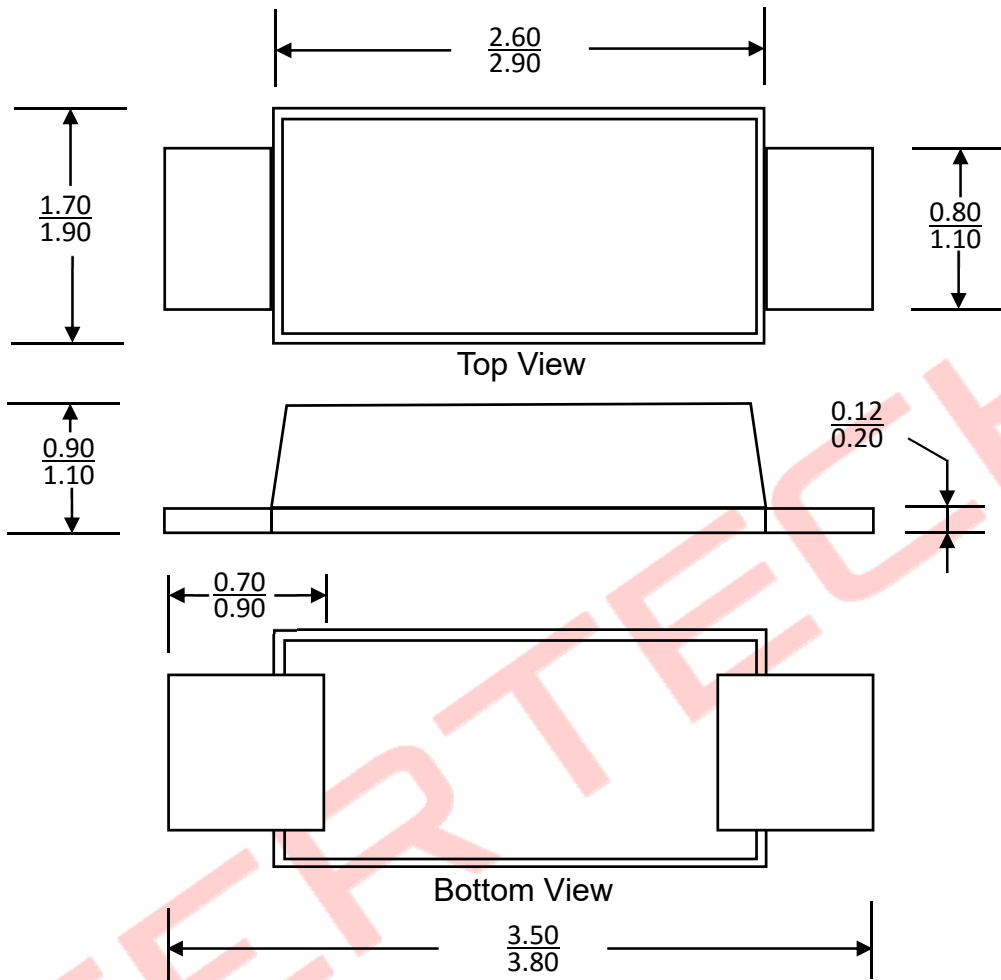

Dimensions in millimeters

ORDERING INFORMATION

Device	Package	Shipping
1N5817FL 1N5818FL 1N5819FL	SOD-123FL	3,000/Tape & Reel (7 inches)