

## IV2Q06060D7Z – 650V 60mΩ Gen2 Automotive SiC MOSFET

### Features

- 2<sup>nd</sup> Generation SiC MOSFET Technology with +18V gate drive
- High blocking voltage with low on-resistance
- High speed switching with low capacitance
- High operating junction temperature capability
- Very fast and robust intrinsic body diode
- Kelvin gate input easing driver circuit design

### Applications

- Motor drivers
- Solar inverters
- Automotive DC/DC converters
- Automotive compressor inverters
- Switch mode power supplies

### Outline:



TO263-7

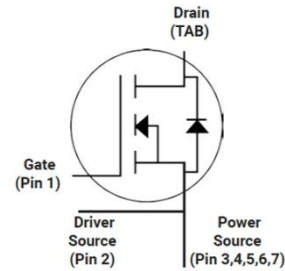

### Marking Diagram:

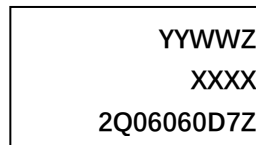

2Q06060D7Z = Specific Device Code  
 YY = Year  
 WW = Work Week  
 Z = Assembly Location  
 XXXX = Lot Traceability

### Absolute Maximum Ratings (T<sub>c</sub>=25°C unless otherwise specified)

Symbol	Parameter	Value	Unit	Test Conditions	Note
V <sub>DS</sub>	Drain-Source voltage	650	V	V <sub>GS</sub> =0V, I <sub>D</sub> =100μA	
V <sub>GSmax</sub> (DC)	Maximum DC voltage	-5 to 20	V	Static (DC)	
V <sub>GSmax</sub> (Spike)	Maximum spike voltage	-10 to 23	V	Duty cycle<1%, and pulse width<200ns	
V <sub>GSon</sub>	Recommended turn-on voltage	18±0.5	V		
V <sub>GSoff</sub>	Recommended turn-off voltage	-3.5 to -2	V		
I <sub>D</sub>	Drain current (continuous)	43	A	V <sub>GS</sub> =18V, T <sub>c</sub> =25°C	Fig. 23
		32	A	V <sub>GS</sub> =18V, T <sub>c</sub> =100°C	
I <sub>DM</sub>	Drain current (pulsed)	108	A	Pulse width limited by SOA	Fig. 26
P <sub>TOT</sub>	Total power dissipation	174	W	T <sub>c</sub> =25°C	Fig. 24
T <sub>stg</sub>	Storage temperature range	-55 to 175	°C		
T <sub>J</sub>	Operating junction temperature	-55 to 175	°C		
T <sub>L</sub>	Solder Temperature	260	°C	wave soldering only allowed at leads, 1.6mm from case for 10 s	

### Thermal Data

Symbol	Parameter	Value	Unit	Note
R <sub>θ(j-c)</sub>	Thermal Resistance from Junction to Case	0.86	°C/W	Fig. 25

**Electrical Characteristics** ( $T_c=25^\circ\text{C}$  unless otherwise specified)

Symbol	Parameter	Value			Unit	Test Conditions	Note
		Min.	Typ.	Max.			
$I_{DSS}$	Zero gate voltage drain current		3	100	$\mu\text{A}$	$V_{DS}=650\text{V}, V_{GS}=0\text{V}$	
$I_{GSS}$	Gate leakage current			$\pm 100$	$\text{nA}$	$V_{DS}=0\text{V}, V_{GS}=-5\sim 20\text{V}$	
$V_{TH}$	Gate threshold voltage	1.8	2.8	4.5	$\text{V}$	$V_{GS}=V_{DS}, I_D=5\text{mA}$	Fig. 8, 9
			2.0			$V_{GS}=V_{DS}, I_D=5\text{mA}$ @ $T_J=175^\circ\text{C}$	
$R_{ON}$	Static drain-source on-resistance		60	78	$\text{m}\Omega$	$V_{GS}=18\text{V}, I_D=15\text{A}$ @ $T_J=25^\circ\text{C}$	Fig. 4, 5, 6, 7
			84		$\text{m}\Omega$	$V_{GS}=18\text{V}, I_D=15\text{A}$ @ $T_J=175^\circ\text{C}$	
$C_{iss}$	Input capacitance		1218		$\text{pF}$	$V_{DS}=600\text{V}, V_{GS}=0\text{V},$ $f=1\text{MHz}, V_{AC}=25\text{mV}$	Fig. 16
$C_{oss}$	Output capacitance		118		$\text{pF}$		
$C_{rss}$	Reverse transfer capacitance		7.6		$\text{pF}$		
$E_{oss}$	$C_{oss}$ stored energy		24.6		$\mu\text{J}$		Fig. 17
$Q_g$	Total gate charge		64		$\text{nC}$	$V_{DS}=400\text{V}, I_D=15\text{A},$ $V_{GS}=-3$ to $18\text{V}$	Fig. 18
$Q_{gs}$	Gate-source charge		14		$\text{nC}$		
$Q_{gd}$	Gate-drain charge		33		$\text{nC}$		
$R_g$	Gate input resistance		4.7		$\Omega$	$f=1\text{MHz}$	
$E_{ON}$	Turn-on switching energy		87.4		$\mu\text{J}$	$V_{DS}=400\text{V}, I_D=15\text{A},$ $V_{GS}=-3.5$ to $18\text{V},$ $R_{G(ext)}=3.3\Omega,$ $L=200\mu\text{H}$ $T_J=25^\circ\text{C}$	Fig. 19, 20
$E_{OFF}$	Turn-off switching energy		11.0		$\mu\text{J}$		
$t_{d(on)}$	Turn-on delay time		5.0		$\text{ns}$		
$t_r$	Rise time		11.2				
$t_{d(off)}$	Turn-off delay time		13.1				
$t_f$	Fall time		9.2				
$E_{ON}$	Turn-on switching energy		118.5		$\mu\text{J}$	$V_{DS}=400\text{V}, I_D=15\text{A},$ $V_{GS}=-3.5$ to $18\text{V},$ $R_{G(ext)}=3.3\Omega, L=200\mu\text{H}$ $T_J=175^\circ\text{C}$	Fig. 22
$E_{OFF}$	Turn-off switching energy		11.1		$\mu\text{J}$		

**Reverse Diode Characteristics** ( $T_c=25^\circ\text{C}$  unless otherwise specified)

Symbol	Parameter	Value			Unit	Test Conditions	Note
		Min.	Typ.	Max.			
$V_{SD}$	Diode forward voltage		4.2		$\text{V}$	$I_{SD}=15\text{A}, V_{GS}=0\text{V}$	Fig. 10, 11, 12
			3.9		$\text{V}$	$I_{SD}=15\text{A}, V_{GS}=0\text{V},$ $T_J=175^\circ\text{C}$	
$t_{rr}$	Reverse recovery time		30.4		$\text{ns}$	$V_{GS}=-3.5\text{V}/+18\text{V},$ $I_{SD}=15\text{A}, V_R=400\text{V},$	
$Q_{rr}$	Reverse recovery charge		97.4		$\text{nC}$	$R_{G(ext)}=15\Omega, L=200\mu\text{H}$	
$I_{RRM}$	Peak reverse recovery current		13.5		$\text{A}$	$di/dt=3000\text{A}/\mu\text{s}$	

## Typical Performance (curves)

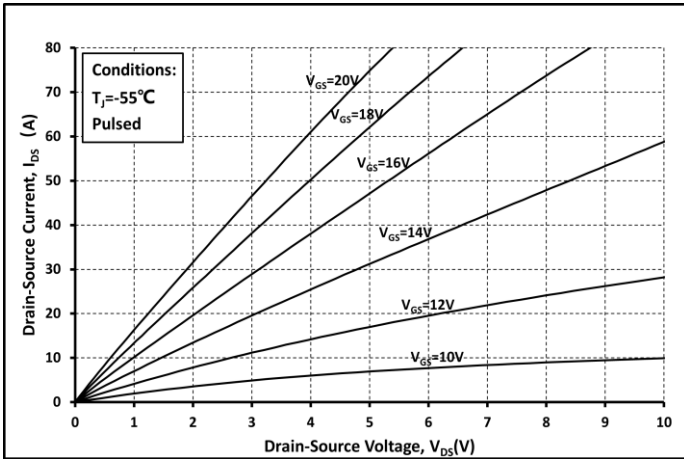

Fig. 1 Output Curve @  $T_j = -55^\circ\text{C}$

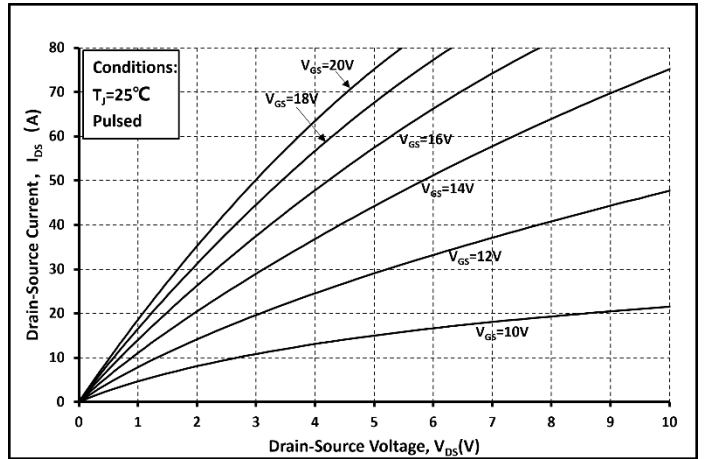

Fig. 2 Output Curve @  $T_j = 25^\circ\text{C}$

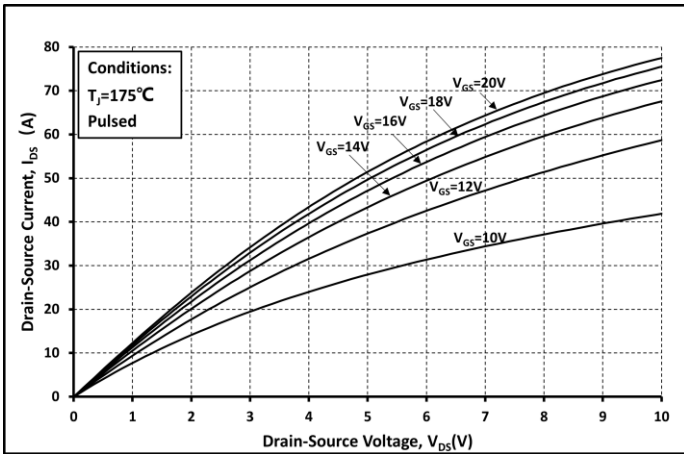

Fig. 3 Output Curve @  $T_j = 175^\circ\text{C}$

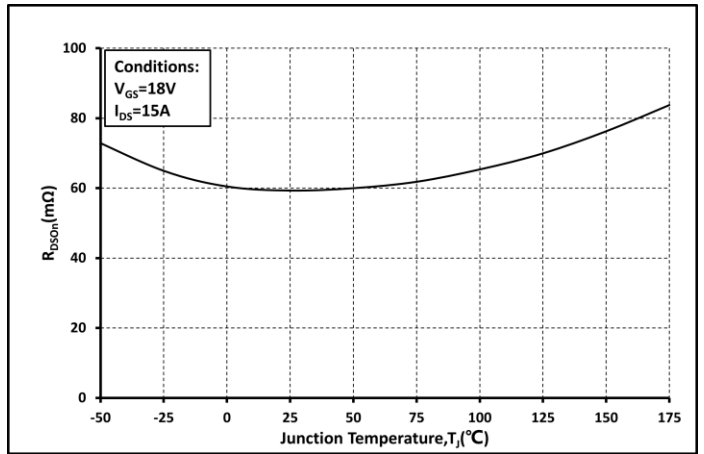

Fig. 4  $R_{DS(on)}$  vs. Temperature

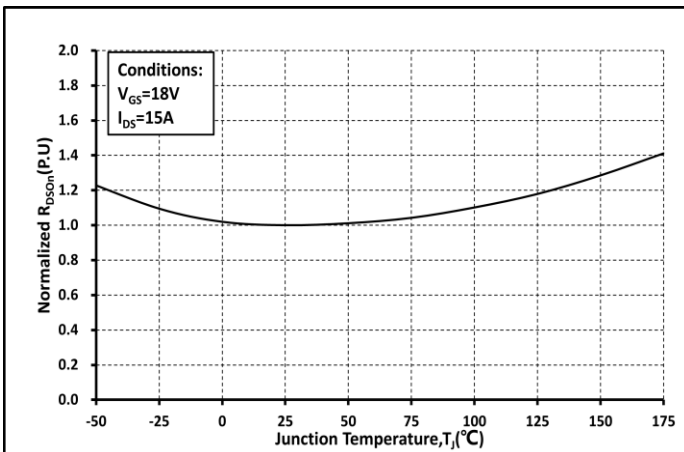

Fig. 5 Normalized  $R_{DS(on)}$  vs. Temperature

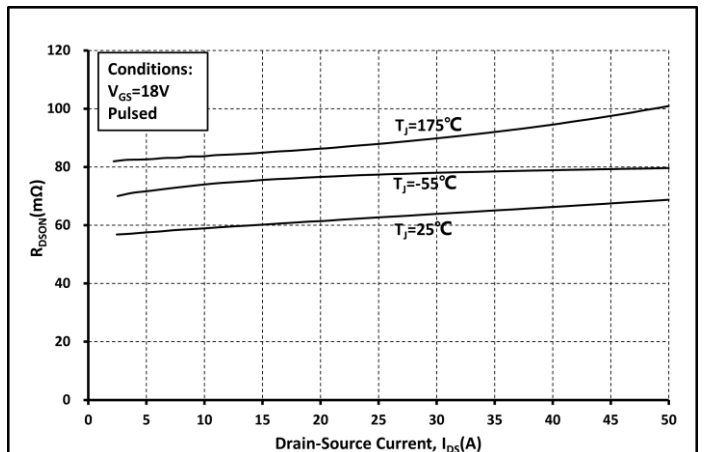

Fig. 6  $R_{DS(on)}$  vs.  $I_{DS}$  @ Various Temperature

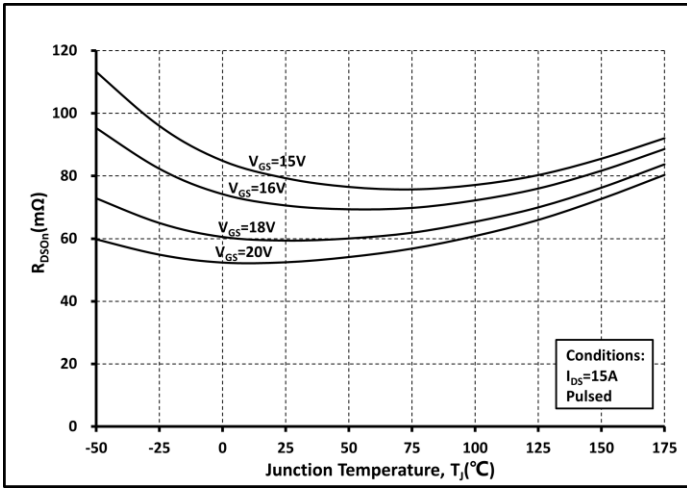

Fig. 7 Ron vs. Temperature @ Various  $V_{GS}$

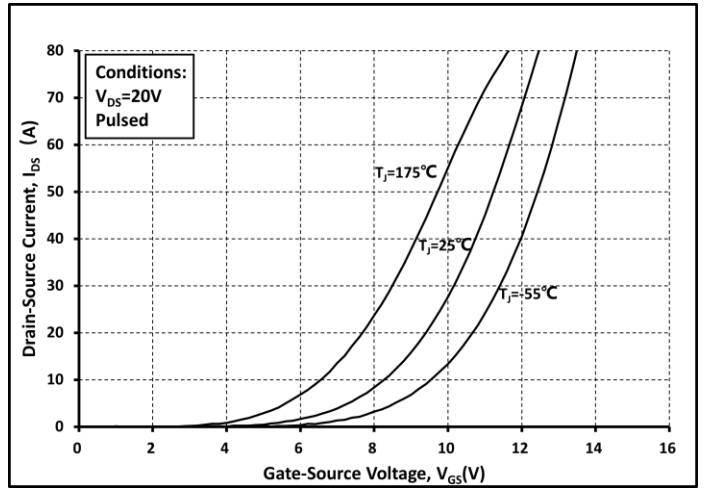

Fig. 8 Transfer Curves @ Various Temperature

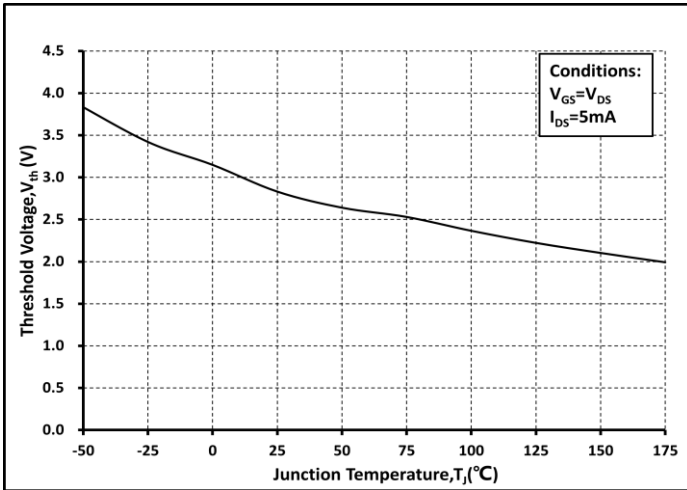

Fig. 9 Threshold Voltage vs. Temperature

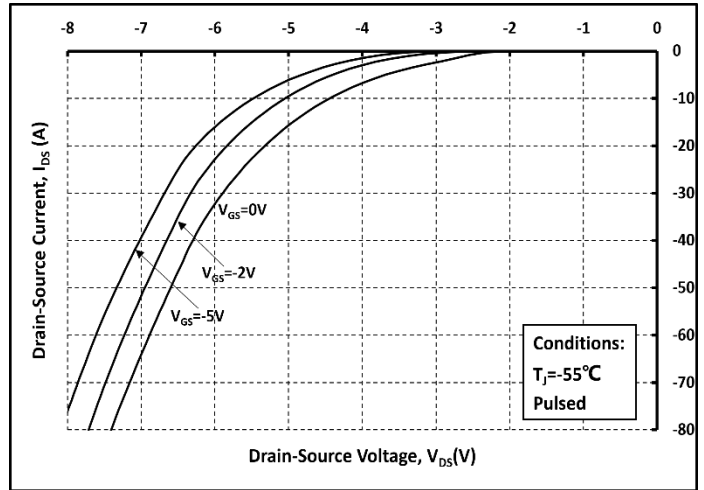

Fig. 10 Body Diode curves @  $T_j = -55^\circ\text{C}$

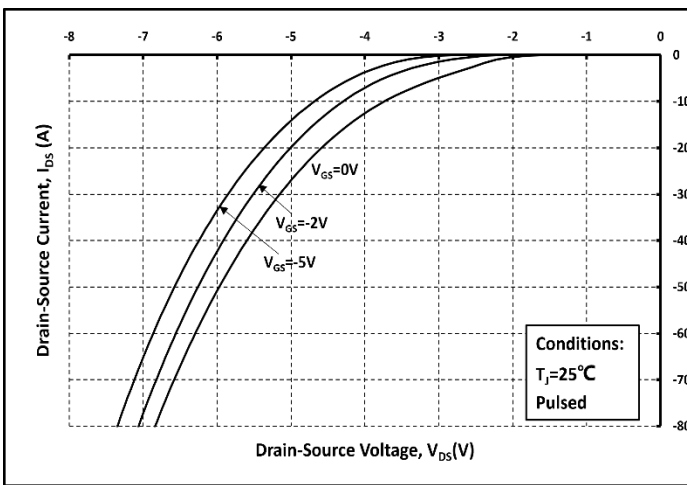

Fig. 11 Body Diode curves @  $T_j = 25^\circ\text{C}$

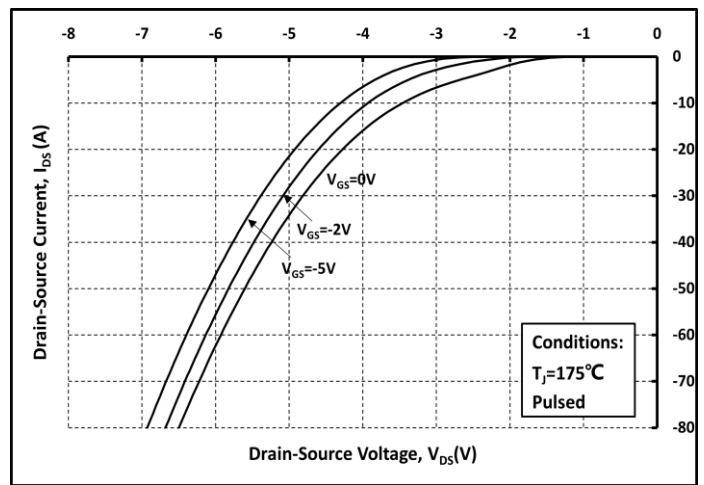

Fig. 12 Body Diode curves @  $T_j = 175^\circ\text{C}$

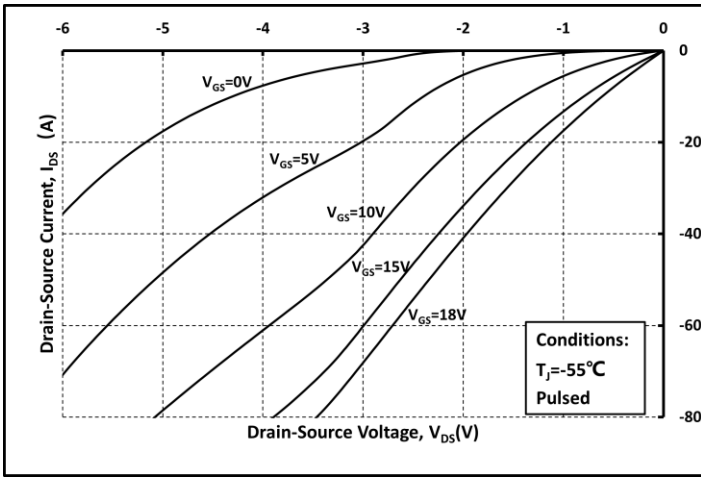

Fig. 13 3<sup>rd</sup> Quadrant curves @  $T_j = -55^\circ\text{C}$

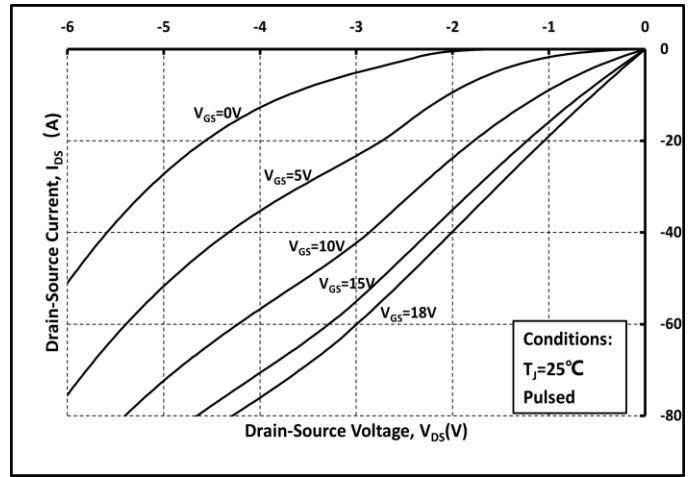

Fig. 14 3<sup>rd</sup> Quadrant curves @  $T_j = 25^\circ\text{C}$

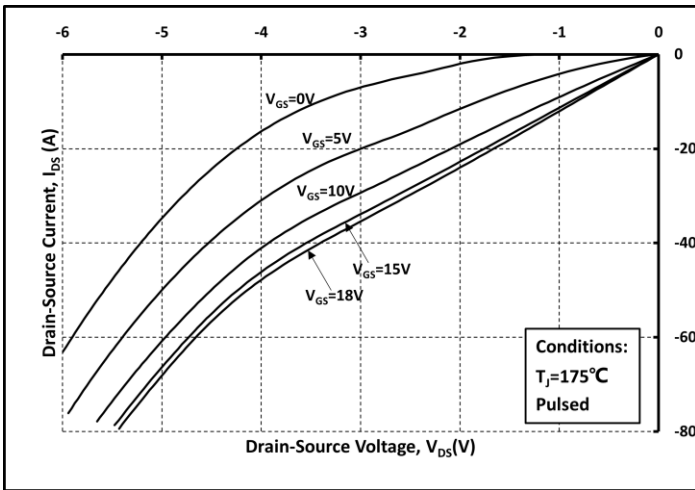

Fig. 15 3<sup>rd</sup> Quadrant curves @  $T_j = 175^\circ\text{C}$

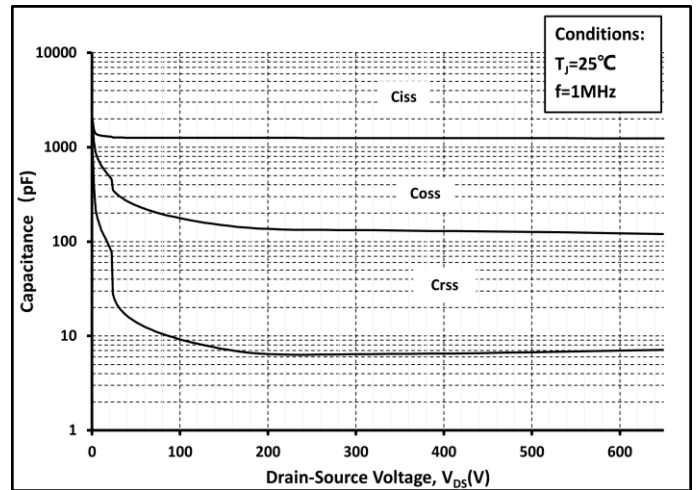

Fig. 16 Capacitance vs.  $V_{DS}$

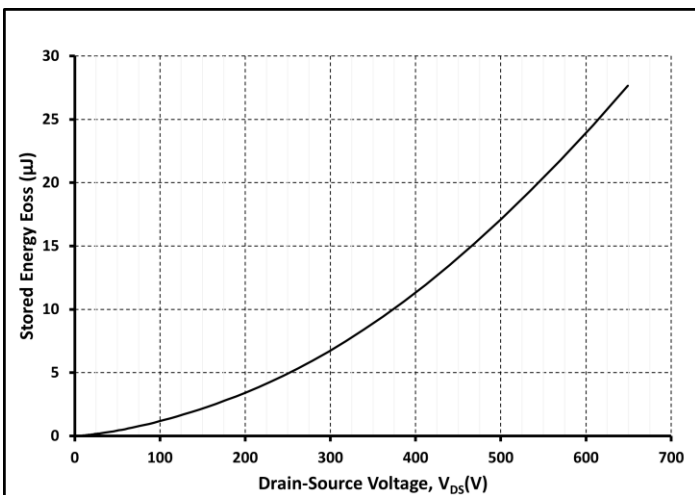

Fig. 17 Output Capacitor Stored Energy

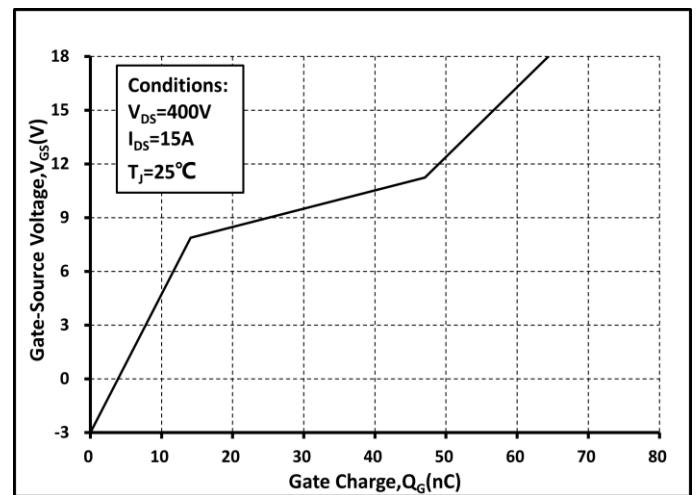

Fig. 18 Gate Charge Characteristics

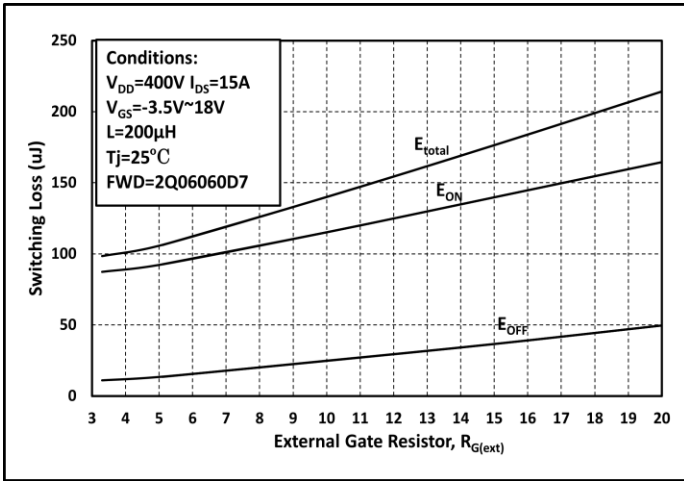

Fig. 19 Switching Energy vs.  $R_{G(ext)}$

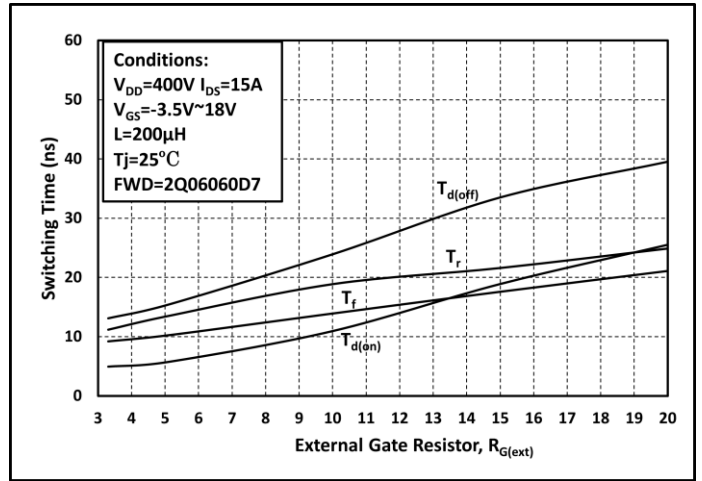

Fig. 20 Switching Times vs.  $R_{G(ext)}$

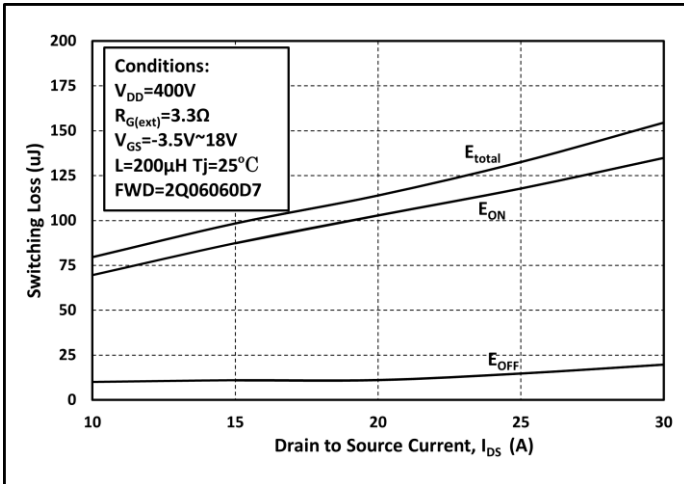

Fig. 21 Switching Energy vs.  $I_{DS}$

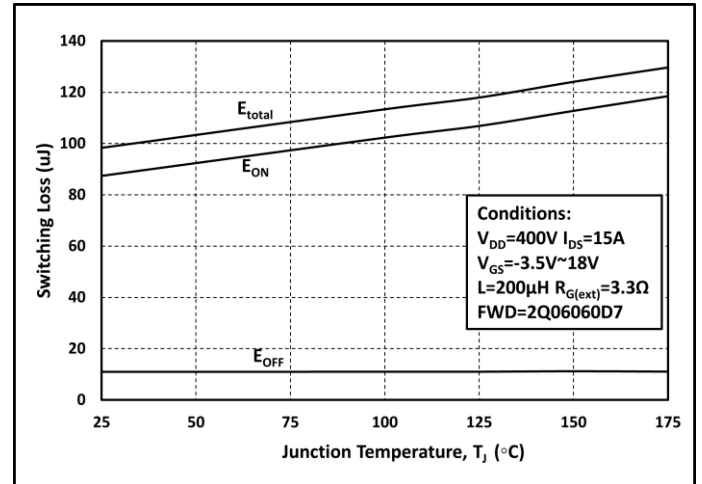

Fig. 22 Switching Energy vs. Temperature

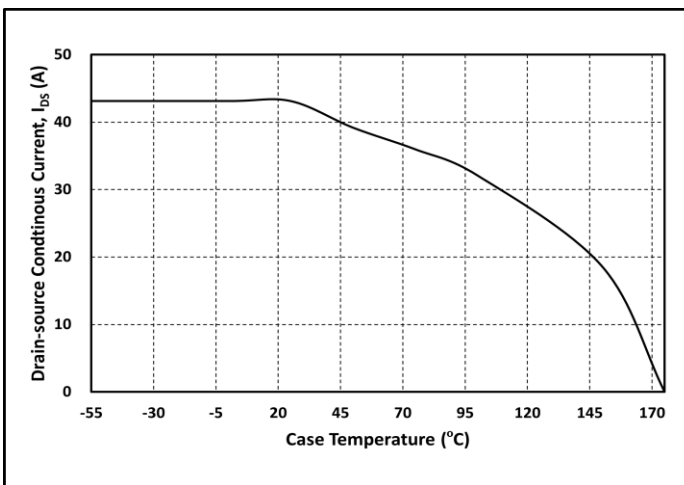

Fig. 23 Continuous Drain Current vs. Case Temperature

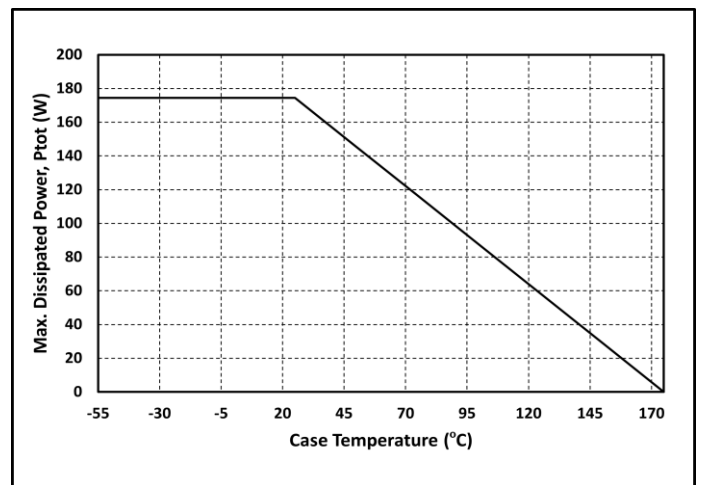

Fig. 24 Max. Power Dissipation Derating vs. Case Temperature

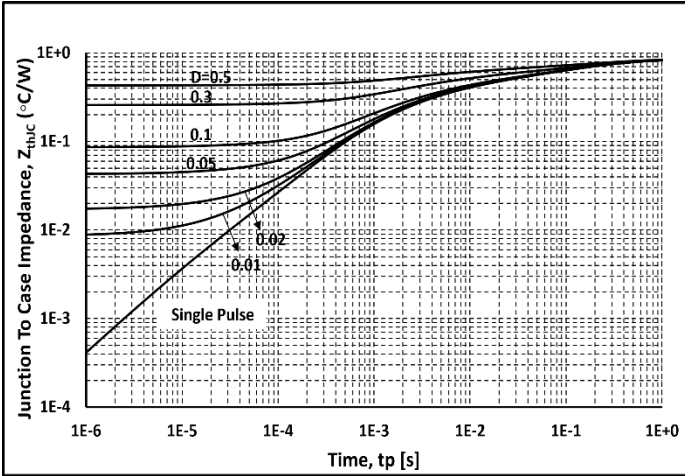

Fig. 25 Thermal impedance

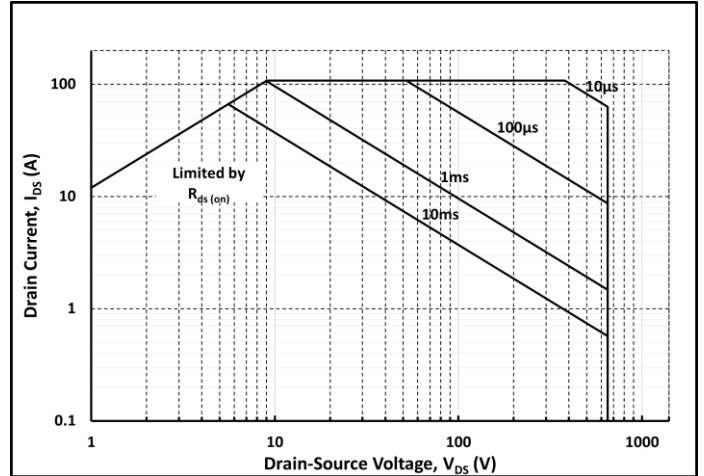
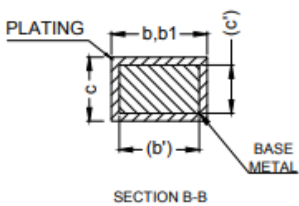
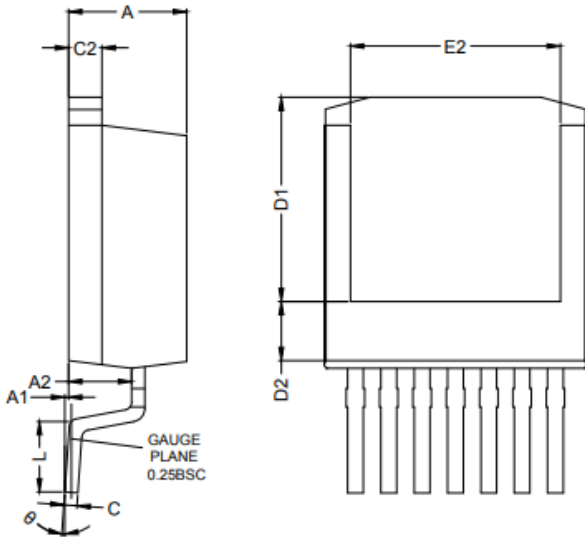
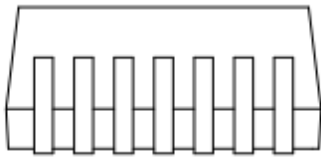
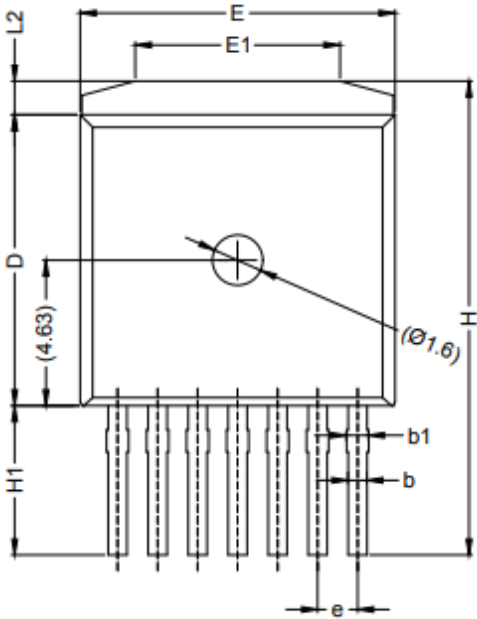

Fig. 26 Safe Operating Area

## Package Dimensions



Items	Min	Max
A	4.30	4.70
A1	-	0.25
A2	2.20	2.60
b	0.52	0.72
b'	0.50	0.70
b1	0.60	0.80
c	0.42	0.62
c'	0.40	0.60
c2	1.07	1.47
D	9.05	9.45
D1	7.58	7.98
D2	2.05	2.45
e	1.27 BSC	
E	9.80	10.20
E1	6.30	6.70
E2	7.80	8.20
L	2.48	2.88
L2	0.87	1.27
H	14.87	15.27
H1	4.55	4.95
θ	0°	8°

### Note:

1. Package Reference: JEDEC TO263, Variation AD
2. All Dimensions are in mm
3. Subject to Change Without Notice



## Notes

For further information please contact IVCT's office.

Copyright©2023 InventChip Technology Co., Ltd. All rights reserved.

The Information in this document is subject to change without notice.

## Related Links

<http://www.inventchip.com.cn>

