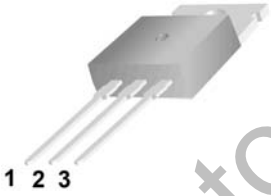
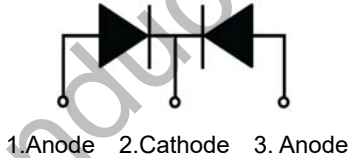
 <p><b>MBR20200SCT</b></p> <p><b>Features:</b></p> <ul style="list-style-type: none"> <li><input type="checkbox"/> Low power loss, high efficiency. High surge capacity</li> <li><input type="checkbox"/> For use in low voltage, high frequency inverters, free wheeling, and polarity protection applications.</li> <li><input type="checkbox"/> Metal silicon junction, majority carrier conduction.</li> <li><input type="checkbox"/> High current Capability, low forward voltage drop.</li> <li><input type="checkbox"/> Guard ring for over voltage protection.</li> </ul>	<p style="text-align: center;">TO-220 </p>   <p style="text-align: center;">1.Anode 2.Cathode 3. Anode</p>
--	---

**Absolute Maximum Ratings** (Ta=25°C unless otherwise noted)

Parameter	Symbol	Value	Unit
Maximum Recurrent Peak Reverse Voltage	$V_{RRM}$	200	V
Maximum RMS Voltage	$V_{RMS}$	140	V
Maximum DC Blocking Voltage	$V_{R(DC)}$	200	V
Maximum Average Forward Current	$I_{F(AV)}$	20	A
Peak Forward Surge Current:8.3ms single half sine-wave superimposed on rated load (JEDEC method)	$I_{FSM}$	180	A
Maximum Forward Voltage	$V_F$	0.95	V
Maximum DC Reverse Current	Tj=25°C	0.1	mA
	Tj=125°C	20	mA
Maximum Operating Junction Temperature	$T_j$	150	°C
Storage Temperature	$T_{stg}$	-40~+150	°C

Typical Characteristics

RATING AND CHARACTERISTIC CURVES

FIG. 1- FORWARD CURRENT DERATING CURVE

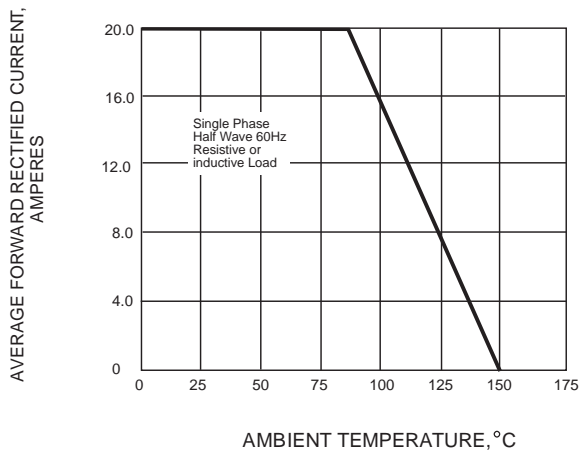

FIG. 2-MAXIMUM NON-REPETITIVE PEAK FORWARD SURGE CURRENT

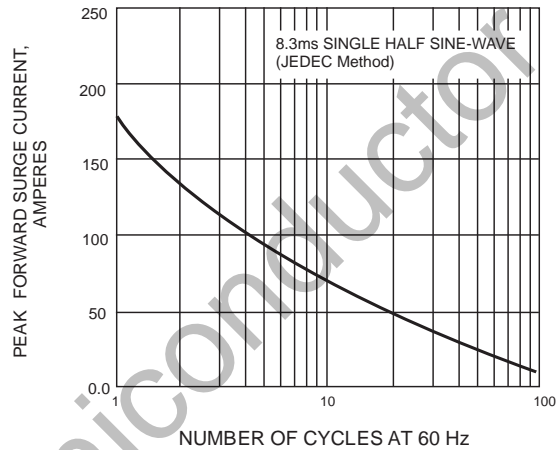

FIG. 3-TYPICAL INSTANTANEOUS FORWARD CHARACTERISTICS

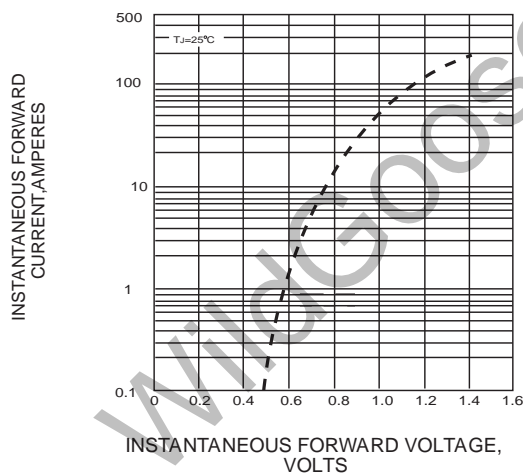
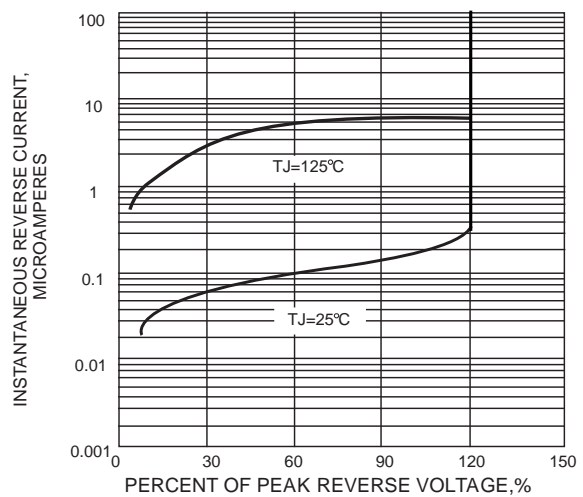
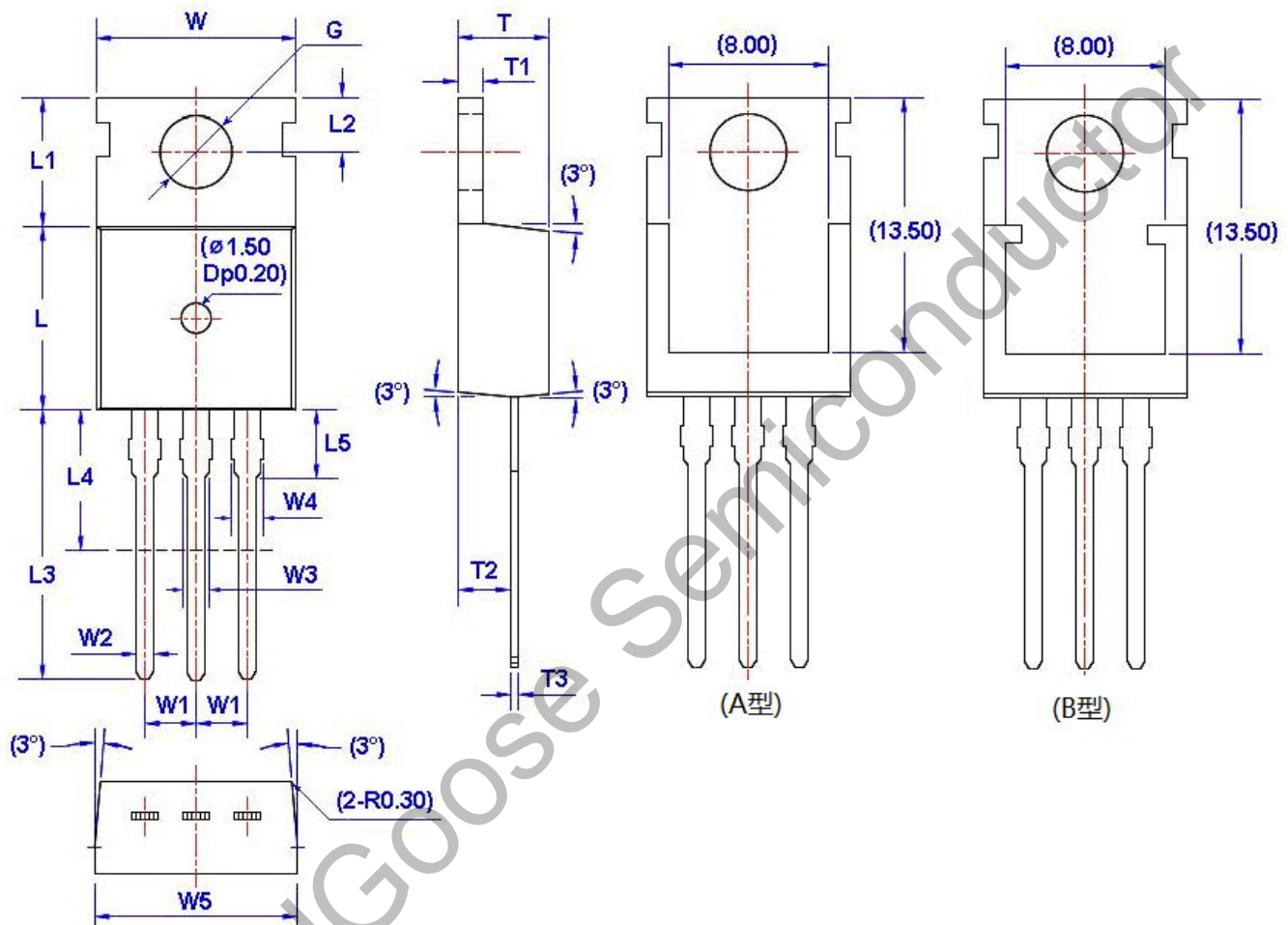

FIG. 4-TYPICAL REVERSE CHARACTERISTICS



**Package Dimension**

TO-220



Symbol	Size		Symbol	Size		Symbol	Size		Symbol	Size	
	Min	Max		Min	Max		Min	Max		Min	Max
W	9.66	10.28	W5	9.80	10.20	L4**	6.20	6.60	T3	0.45	0.60
W1	2.54 (TYP)		L	9.00	9.40	L5	2.79	3.30	G( $\Phi$ )	3.50	3.70
W2	0.70	0.95	L1	6.40	6.80	T	4.30	4.70			
W3	1.17	1.37	L2	2.70	2.90	T1	1.15	1.40			
W4*	1.32	1.72	L3	12.70	14.27	T2	2.20	2.60			