



Description

The DMG7401SFG uses advanced trench technology and design to provide excellent $R_{DS(ON)}$ with low gate charge .This device is well suited for high current load applications.

General Features

$V_{DS} = -30V, I_D = -32A$

$R_{DS(ON)} < 12m\Omega @ V_{GS} = -10V$

$R_{DS(ON)} < 18m\Omega @ V_{GS} = -4.5V$

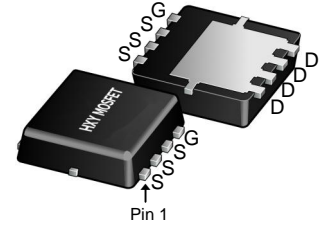

DFN3X3-8L

Application

High side switch for full bridge converter
DC/DC converter for LCD display

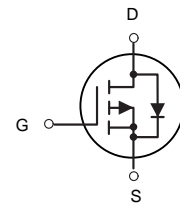

P-Channel MOSFET

Package Marking and Ordering Information

Product ID	Pack	Brand	Qty(PCS)
DMG7401SFG	DFN3X3-8L	HXY MOSFET	5000

Absolute Maximum Ratings@ $T_J = 25^\circ C$ (unless otherwise specified)

Symbol	Parameter	Rating	Units
V _{DS}	Drain-Source Voltage	-30	V
V _{GS}	Gate-Source Voltage	+25	V
I _D @T _A =25°C	Drain Current ³ , V _{GS} @ 10V	-32	A
I _D @T _A =70°C	Drain Current ³ , V _{GS} @ 10V	-9.8	A
I _{DM}	Pulsed Drain Current ¹	-65	A
P _D @T _A =25°C	Total Power Dissipation	3.57	W
T _{STG}	Storage Temperature Range	-55 to 150	°C
T _J	Operating Junction Temperature Range	-55 to 150	°C
R _{thj-c}	Maximum Thermal Resistance, Junction-case	6	°C/W
R _{thj-a}	Maximum Thermal Resistance, Junction-ambient ³	35	°C/W



Electrical Characteristics@T_j=25°C(unless otherwise specified)

Symbol	Parameter	Test Conditions	Min.	Typ.	Max.	Units
BV _{DSS}	Drain-Source Breakdown Voltage	V _{GS} =0V, I _D =-250uA	-30	-	-	V
RDS(ON)	Static Drain-Source On-Resistance ²	V _{GS} =-10V, I _D =-15A	-	10	12	mΩ
		V _{GS} =-4.5V, I _D =-10A	-	14	18	mΩ
VGS(th)	Gate Threshold Voltage	V _{DS} =V _{GS} , I _D =-250uA	-1	1.95	-2.5	V
g _{fs}	Forward Transconductance	V _{DS} =-10V, I _D =-6A	-	19	-	S
IDSS	Drain-Source Leakage Current	V _{DS} =-24V, V _{GS} =0V	-	-	-30	uA
IGSS	Gate-Source Leakage	V _{GS} =±20V, V _{DS} =0V	-	-	±100	nA
Q _g	Total Gate Charge	I _D =-15A	-	12.5	24	nC
Q _{gs}	Gate-Source Charge	V _{DS} =-15V	-	5.4	-	nC
Q _{gd}	Gate-Drain ("Miller") Charge	V _{GS} =-4.5V	-	5	-	nC
td(on)	Turn-on Delay Time	V _{DS} =-15V	-	4.4	-	ns
t _r	Rise Time	I _D =-15A	-	11.2	-	ns
td(off)	Turn-off Delay Time	R _G =3.3Ω	-	34	-	ns
t _f	Fall Time	V _{GS} =-10V	-	18	-	ns
C _{iss}	Input Capacitance	V _{GS} =0V	-	1345	2000	pF
C _{oss}	Output Capacitance	V _{DS} =-15V f=1.0MHz	-	194	-	pF
C _{rss}	Reverse Transfer Capacitance		-	158	-	pF
t _{rr}	Reverse Recovery Time	I _S =-15A, V _{GS} =0V, dI/dt=100A/μs	-	12.4	-	ns
Q _{rr}	Reverse Recovery Charge		-	5	-	nC

Notes:

- 1.Pulse width limited by Max. junction temperature.
- 2.Pulse test



Typical Electrical

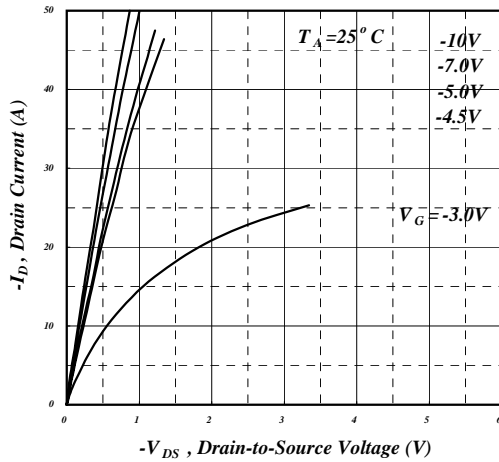

Fig 1. Typical Output Characteristics

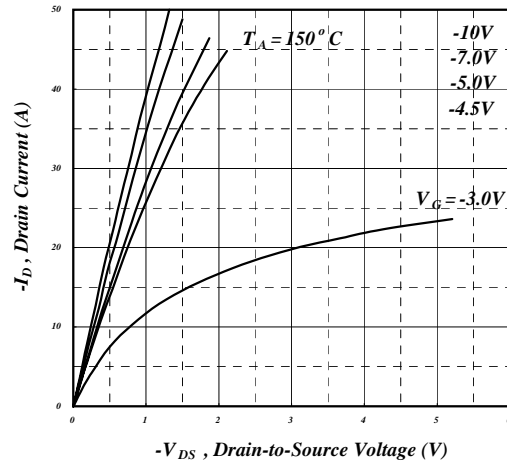

Fig 2. Typical Output Characteristics

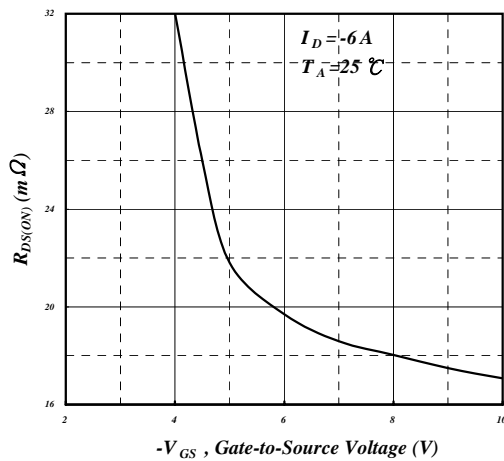

Fig 3. On-Resistance v.s. Gate Voltage

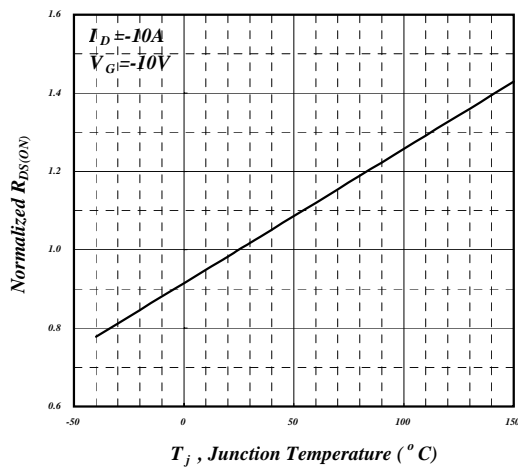

Fig 4. Normalized On-Resistance v.s. Junction Temperature

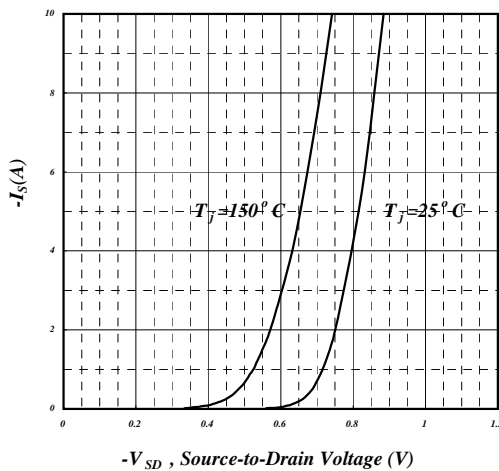

Fig 5. Forward Characteristic of Reverse Diode

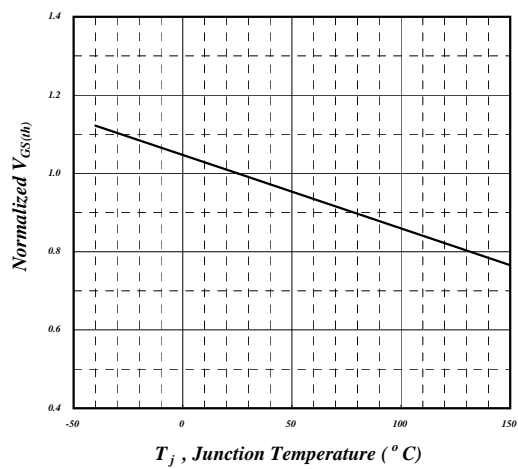

Fig 6. Gate Threshold Voltage v.s. Junction Temperature

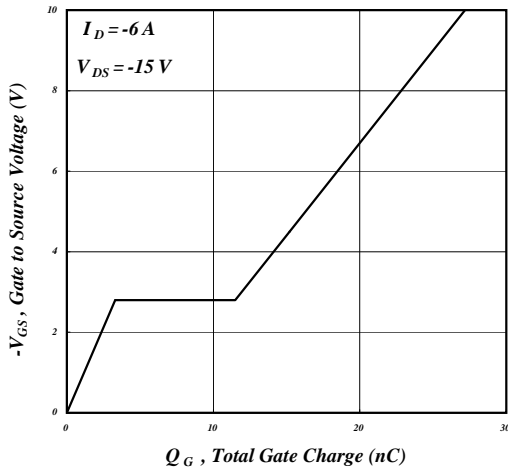

Fig 7. Gate Charge Characteristics

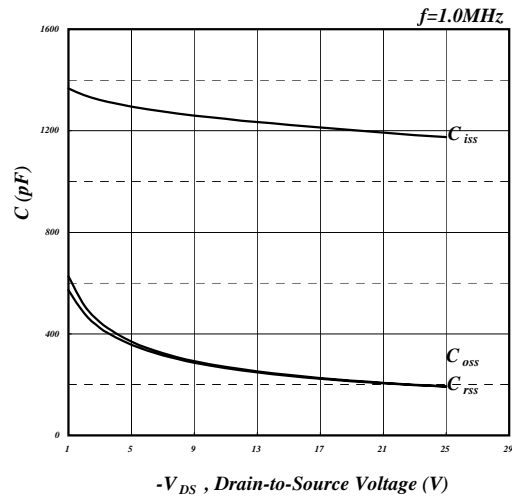

Fig 8. Typical Capacitance Characteristics

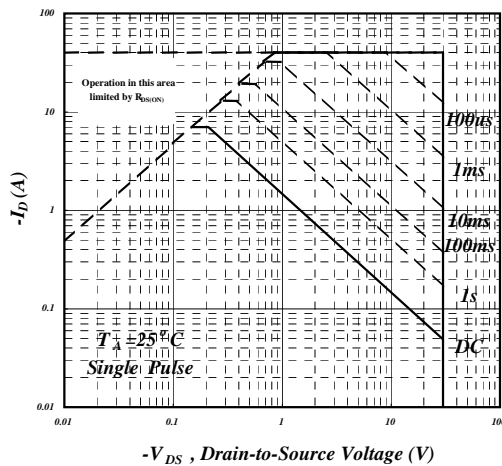

Fig 9. Maximum Safe Operating Area

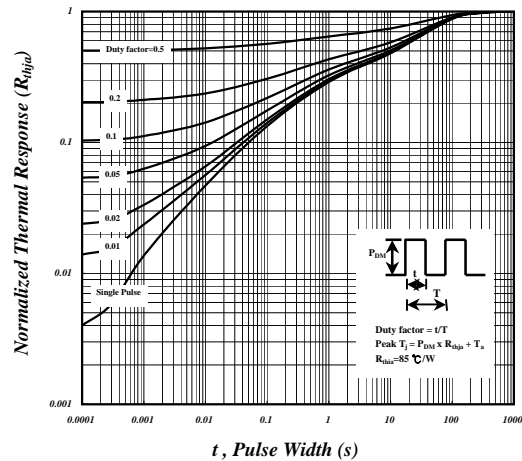

Fig 10. Effective Transient Thermal Impedance

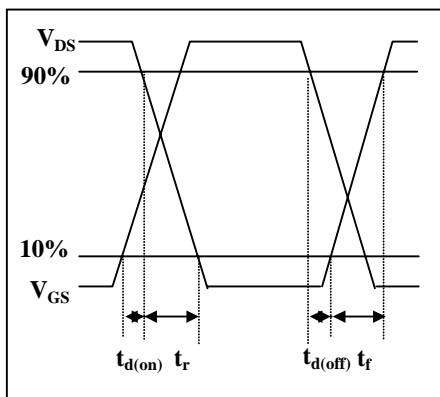

Fig 11. Switching Time Waveform

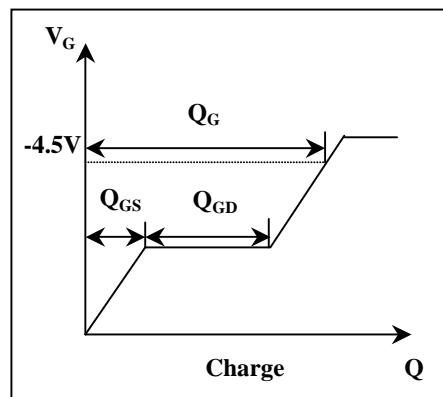
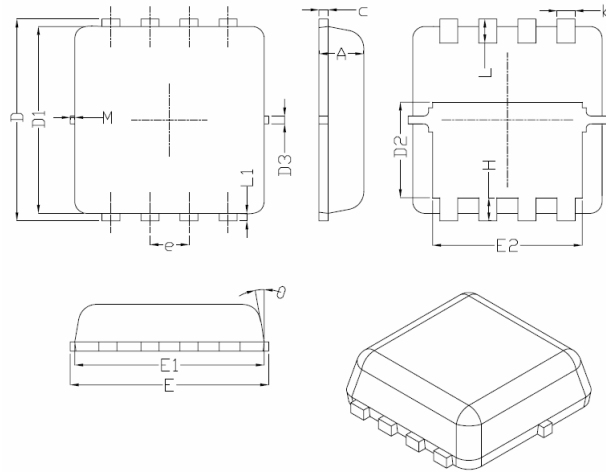

Fig 12. Gate Charge Waveform



DFN3X3-8L Package Information



Symbol	Dimensions In Millimeters		
	Min.	Nom.	Max.
A	0.70	0.75	0.80
b	0.25	0.30	0.35
c	0.10	0.15	0.25
D	3.25	3.35	3.45
D1	3.00	3.10	3.20
D2	1.48	1.58	1.68
D3	-	0.13	-
E	3.20	3.30	3.40
E1	3.00	3.15	3.20
E2	2.39	2.49	2.59
e	0.65BSC		
H	0.30	0.39	0.50
L	0.30	0.40	0.50
L1	-	0.13	-
M	*	*	0.15
θ		10°	12°



Attention

- Any and all HUA XUAN YANG ELECTRONICS products described or contained herein do not have specifications that can handle applications that require extremely high levels of reliability, such as life-support systems, aircraft's control systems, or other applications whose failure can be reasonably expected to result in serious physical and/or material damage. Consult with your HUA XUAN YANG ELECTRONICS representative nearest you before using any HUA XUAN YANG ELECTRONICS products described or contained herein in such applications.
- HUA XUAN YANG ELECTRONICS assumes no responsibility for equipment failures that result from using products at values that exceed, even momentarily, rated values (such as maximum ratings, operating condition ranges, or other parameters) listed in products specifications of any and all HUA XUAN YANG ELECTRONICS products described or contained herein.
- Specifications of any and all HUA XUAN YANG ELECTRONICS products described or contained herein stipulate the performance, characteristics, and functions of the described products in the independent state, and are not guarantees of the performance, characteristics, and functions of the described products as mounted in the customer's products or equipment. To verify symptoms and states that cannot be evaluated in an independent device, the customer should always evaluate and test devices mounted in the customer's products or equipment.
- HUA XUAN YANG ELECTRONICS CO.,LTD. strives to supply high-quality high-reliability products. However, any and all semiconductor products fail with some probability. It is possible that these probabilistic failures could give rise to accidents or events that could endanger human lives, that could give rise to smoke or fire, or that could cause damage to other property. When designing equipment, adopt safety measures so that these kinds of accidents or events cannot occur. Such measures include but are not limited to protective circuits and error prevention circuits for safe design, redundant design, and structural design.
- In the event that any or all HUA XUAN YANG ELECTRONICS products(including technical data, services) described or contained herein are controlled under any of applicable local export control laws and regulations, such products must not be exported without obtaining the export license from the authorities concerned in accordance with the above law.
- No part of this publication may be reproduced or transmitted in any form or by any means, electronic or mechanical, including photocopying and recording, or any information storage or retrieval system, or otherwise, without the prior written permission of HUA XUAN YANG ELECTRONICS CO.,LTD.
- Information (including circuit diagrams and circuit parameters) herein is for example only ; it is not guaranteed for volume production. HUA XUAN YANG ELECTRONICS believes information herein is accurate and reliable, but no guarantees are made or implied regarding its use or any infringements of intellectual property rights or other rights of third parties.
- Any and all information described or contained herein are subject to change without notice due to product/technology improvement, etc. When designing equipment, refer to the "Delivery Specification" for the HUA XUAN YANG ELECTRONICS product that you intend to use.