



BSS127

Power MOSFET

0.021A, 600V ENHANCEMENT N-CHANNEL MOSFET

■ DESCRIPTION

The UTC **BSS127** is an enhancement N-channel mode Power FET, it uses UTC's advanced technology to provide customers ultra high switching speed and ultra low gate charge.

■ FEATURES

- * $R_{DS(ON)} \leq 600 \Omega @ V_{GS}=4.5V, I_D=0.016A$
- $R_{DS(ON)} \leq 500 \Omega @ V_{GS}=10V, I_D=0.016A$
- * Ultra Low Gate Charge (Typical 140nC)
- * Ultra High Switching Speed

■ SYMBOL

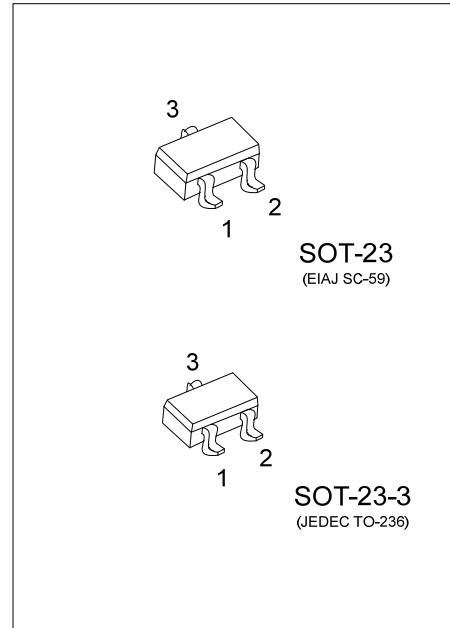
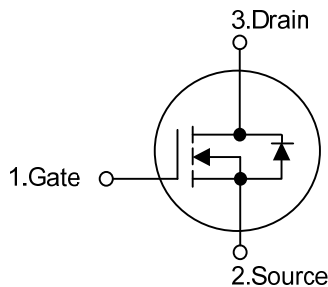

■ ORDERING INFORMATION

Ordering Number		Package	Pin Assignment			Packing
Lead Free	Halogen Free		1	2	3	
BSS127L-AE2-R	BSS127G-AE2-R	SOT-23-3	G	S	D	Tape Reel
BSS127L-AE3-R	BSS127G-AE3-R	SOT-23	G	S	D	Tape Reel

Note: Pin Assignment: G: Gate S: Source D: Drain

<p>BSS127G-AE2-R</p> <p>(1)Packing Type</p> <p>(2)Package Type</p> <p>(3)Green Package</p>	<p>(1) R: Tape Real</p> <p>(2) AE2: SOT-23-3, AE3: SOT-23</p> <p>(3) G: Halogen Free and Lead Free, L: Lead Free</p>
--	--

■ MARKING

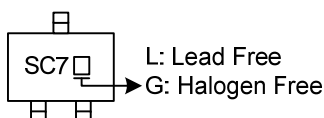

■ ABSOLUTE MAXIMUM RATINGS ($T_A=25^\circ\text{C}$, unless otherwise specified)

PARAMETER		SYMBOL	RATINGS	UNIT
Drain-Source Voltage		V_{DSS}	600	V
Gate-Source Voltage		V_{GSS}	± 20	V
Drain Current	Continuous	$T_A=25^\circ\text{C}$	0.021	A
		$T_A=70^\circ\text{C}$	0.017	A
	Pulsed ($T_A=25^\circ\text{C}$)	I_{DM}	0.09	A
Peak Diode Recovery dv/dt		dv/dt	6	kV/ μs
Power Dissipation ($T_A=25^\circ\text{C}$)		P_D	0.3	W
Junction Temperature		T_J	-55 ~ +150	$^\circ\text{C}$
Storage Temperature Range		T_{STG}	-55 ~ +150	$^\circ\text{C}$

Note: Absolute maximum ratings are those values beyond which the device could be permanently damaged. Absolute maximum ratings are stress ratings only and functional device operation is not implied.

■ THERMAL DATA

PARAMETER	SYMBOL	RATINGS	UNIT
Junction to Ambient	θ_{JA}	325	$^\circ\text{C/W}$

■ ELECTRICAL CHARACTERISTICS ($T_J=25^\circ\text{C}$, unless otherwise specified)

PARAMETER	SYMBOL	TEST CONDITIONS	MIN	TYP	MAX	UNIT
OFF CHARACTERISTICS						
Drain-Source Breakdown Voltage	BV_{DSS}	$I_D=250\mu\text{A}, V_{GS}=0\text{V}$	600			V
Gate-Source Leakage Current		I_{GSS}	$V_{GS}=+20\text{V}, V_{DS}=0\text{V}$	+10	+100	nA
				$V_{GS}=-20\text{V}, V_{DS}=0\text{V}$	-10	-100
Drain-Source Leakage Current		$I_{D(OFF)}$	$V_{GS}=0\text{V}, V_{DS}=600\text{V}, T_J=25^\circ\text{C}$		0.1	μA
				$V_{GS}=0\text{V}, V_{DS}=600\text{V}, T_J=150^\circ\text{C}$		10
ON CHARACTERISTICS						
Gate Threshold Voltage	$V_{GS(TH)}$	$V_{DS}=V_{GS}, I_D=8\mu\text{A}$	1.4	2.0	2.6	V
Static Drain-Source On-State Resistance		$R_{DS(ON)}$	$V_{GS}=4.5\text{V}, I_D=0.016\text{A}$	330	600	Ω
				$V_{GS}=10\text{V}, I_D=0.016\text{A}$	310	500
Forward Transconductance	g_{FS}	$ V_{DS} > 2 I_D R_{DS(ON)MAX}, I_D=0.01\text{A}$	0.007	0.015		S
DYNAMIC PARAMETERS						
Input Capacitance	C_{ISS}	$V_{GS}=0\text{V}, V_{DS}=25\text{V}, f=1.0\text{MHz}$		21	28	pF
Output Capacitance	C_{OSS}		2.4	3	pF	
Reverse Transfer Capacitance	C_{RSS}		1.0	1.5	pF	
SWITCHING PARAMETERS						
Total Gate Charge	Q_G	$V_{GS}=0\sim 10\text{V}, V_{DS}=300\text{V}, I_D=0.01\text{A}$		0.65	1.0	nC
Gate to Source Charge	Q_{GS}		0.07	0.10	nC	
Gate to Drain Charge	Q_{GD}		0.31	0.5	nC	
Gate Plateau Voltage	$V_{plateau}$		3.56		V	
Turn-ON Delay Time	$t_{D(ON)}$	$V_{DD}=300\text{V}, V_{GS}=10\text{V}, I_D=0.01\text{A}, R_G=6\Omega$		6.1	19.0	ns
Rise Time	t_R		9.7	14.5	ns	
Turn-OFF Delay Time	$t_{D(OFF)}$		14	21	ns	
Fall-Time	t_F		115	170	ns	
SOURCE- DRAIN DIODE RATINGS AND CHARACTERISTICS						
Maximum Continuous Drain-Source Diode Forward Current	I_S	$T_A=25^\circ\text{C}$			0.016	A
Maximum Pulsed Drain-Source Diode Forward Current	I_{SM}	$T_A=25^\circ\text{C}$			0.09	A
Drain-Source Diode Forward Voltage	V_{SD}	$I_F=0.016\text{A}, V_{GS}=0\text{V}, T_J=25^\circ\text{C}$		0.82	1.2	V
Body Diode Reverse Recovery Time	t_{rr}	$V_R=300\text{V}, I_F=0.016\text{A}$		160	240	ns
Body Diode Reverse Recovery Charge	Q_{rr}	$dI_F/dt=100\text{A}/\mu\text{s}$		13.2	19.8	μC

Notes: 1. The Power Dissipation of the package may result in a lower continuous drain current.
2. Pulse Test: Pulse Width $\leq 300\mu\text{s}$, Duty Cycle $\leq 2.0\%$.

■ TEST CIRCUITS AND WAVEFORMS

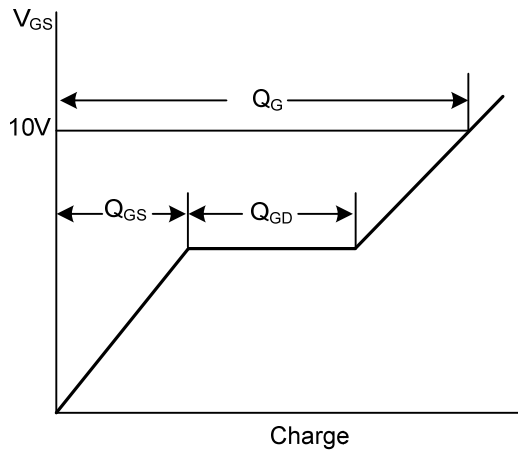

Gate Charge Waveforms

TYPICAL CHARACTERISTICS

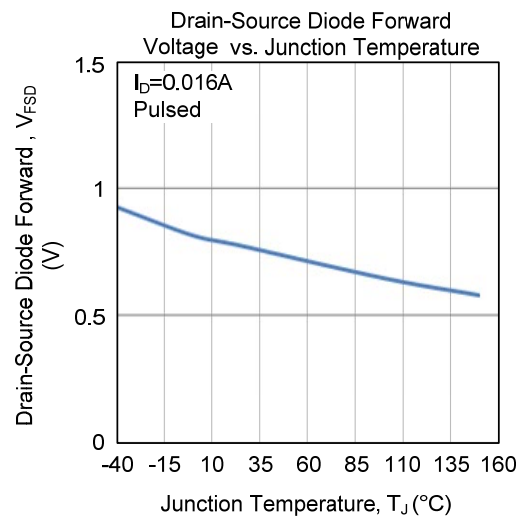
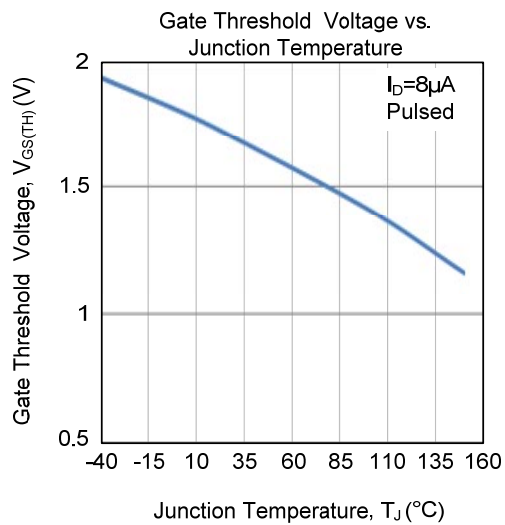
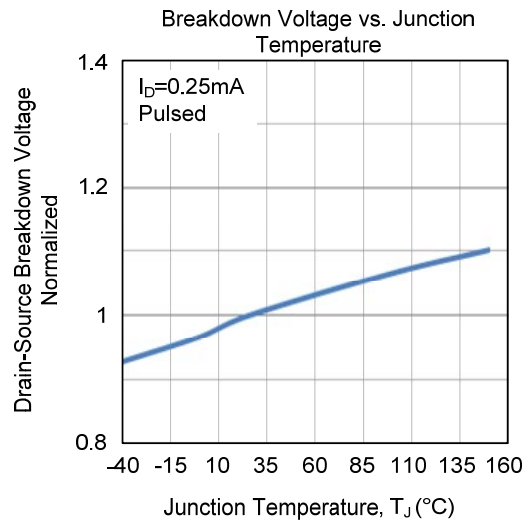
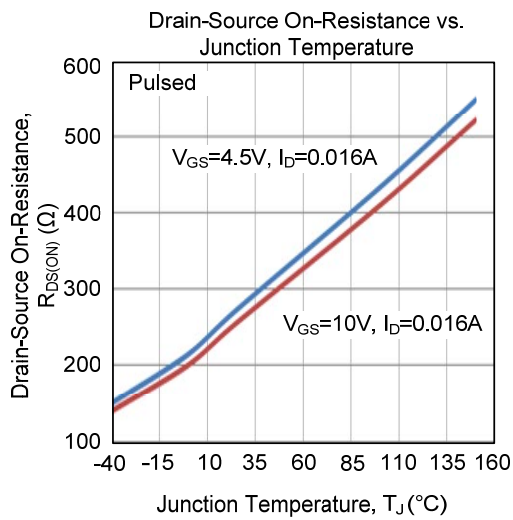
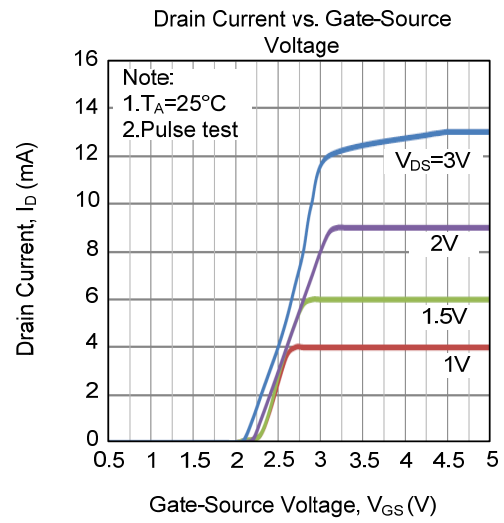
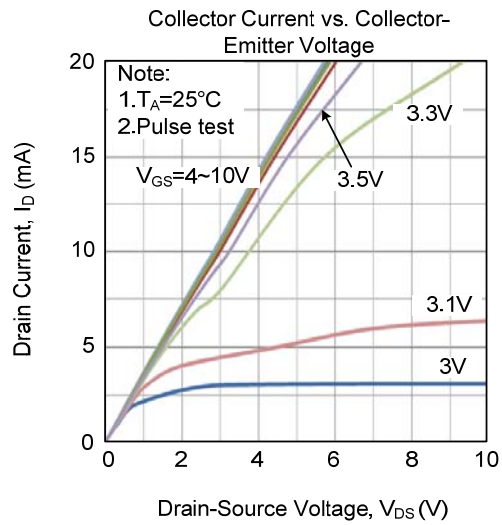

UTC assumes no responsibility for equipment failures that result from using products at values that exceed, even momentarily, rated values (such as maximum ratings, operating condition ranges, or other parameters) listed in products specifications of any and all UTC products described or contained herein. UTC products are not designed for use in life support appliances, devices or systems where malfunction of these products can be reasonably expected to result in personal injury. Reproduction in whole or in part is prohibited without the prior written consent of the copyright owner. UTC reserves the right to make changes to information published in this document, including without limitation specifications and product descriptions, at any time and without notice. This document supersedes and replaces all information supplied prior to the publication hereof.