

REV.	Q'TY	ECN. NO.	APR.	DATE

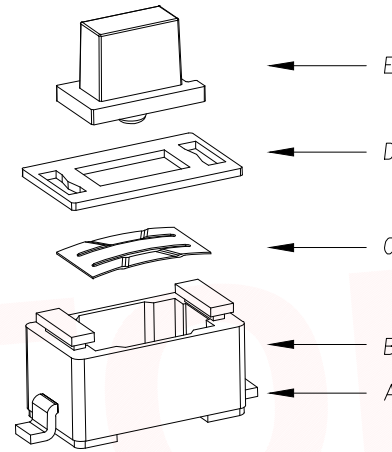

The Main Thchnology Performance

Rate voltage,current	50mA DC12V
Contact resistance	≤100mΩ
Operating force	±30gf
Travel	0.20±0.10mm
Insulated resistance	≥100MΩ
Dielectric strength	≥250VAC/1min

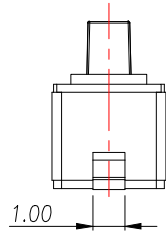
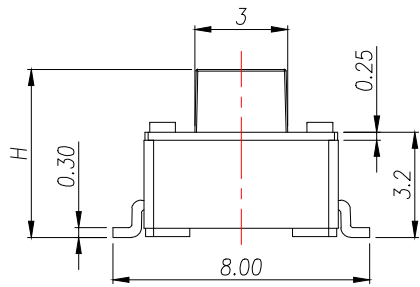
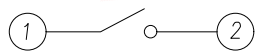
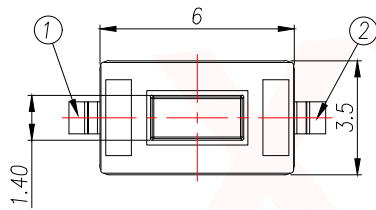

CIRCUIT DIAGRAM

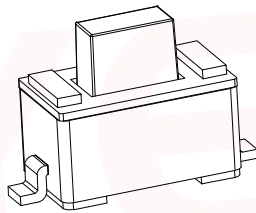

ITEM	DESCRIPTION	MATERIAL	QTY	FINISH/COLOR
E	按钮	PPA	1	白/黑色
D	盖板	铁盖板	1	镀锡
C	弹片	不锈钢	1	镀银
B	本体	PPA	1	白/黑色
A	卡件	黄铜	1	镀银

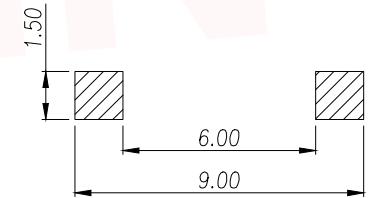

PCB.WELDING DRAWING

T S O 4 - T B W 1

力度: F: 250G
E: 180G
高度: H4.3
H4.5
H5.0

DIMENSION IN mm		厦门市辛译精密电子有限公司 Xiamen XinYi Xyconn Electronics Co.,Ltd	
TOLERANCE UNLESS OTHERWISE SPECIFIED		APR. Alex	TITLE: 3x6 SMD TACT SWITCH
.X±0.35	X.*± 5*	CHK. Jack	DWG NO. TS04-TBW1EHX
.XX±0.25	.X*± 3*	DRA. Can	PROJ. CUSTOMER DRAWING
.XXX±0.15	.XX*± 1*	SIZE A4	SCALE 1:1 SHEET 1/1 REV. A