

|      |      |          |      |      |
|------|------|----------|------|------|
| REV. | Q'TY | ECN. NO. | APR. | DATE |
|      |      |          |      |      |

PRELIMINARY  
DESIGN IS SUBJECT  
TO CHANGE WITHOUT  
PRIOR NOTICE

NOTES:

1. Working temp: -25°C~85°C.
2. Voltage rating: 50V AV/DC(rms)
3. Contact resistance: 50mΩ max.
4. Insulation resistance: 100MΩ min.
5. Current rating: 1A AV/DC
6. Withstanding Voltage: 500V AC/minute
7. Pin Retention Force: 10N min.
8. Housing material: LCP UL94-V0, Natural
9. Terminal materi: Brass,  
plating Ni 50u" min , plating Tin 100u"min.
10. Solder tab material: Brass,  
plating Ni 50u" min , plating Tin 100u"min.

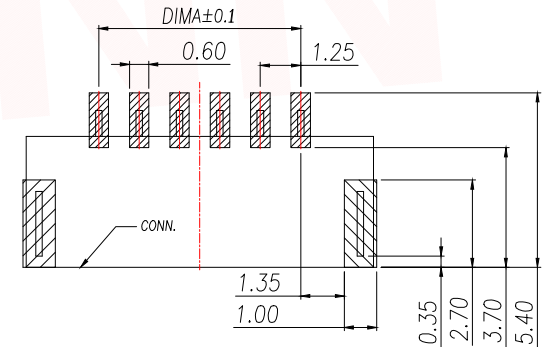
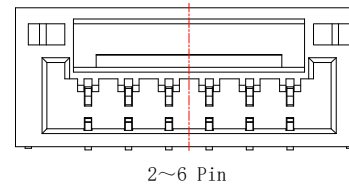
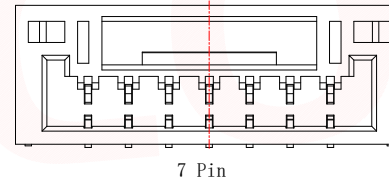
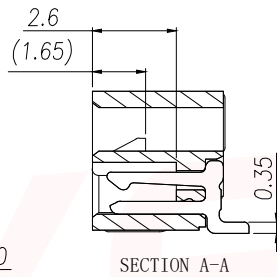
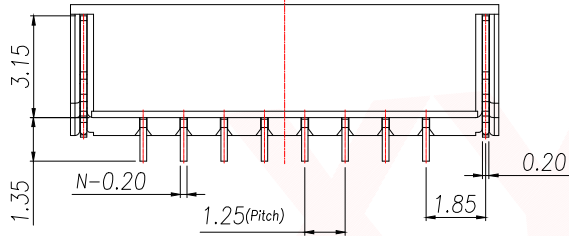
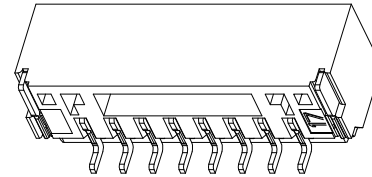
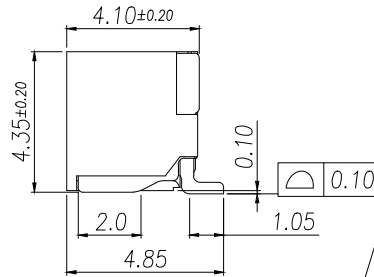
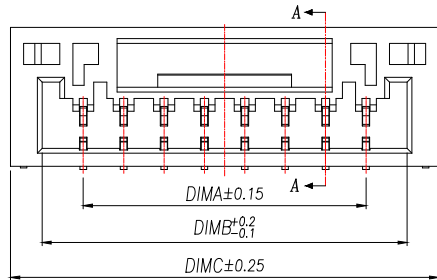

| PIN | NO.             | Dim A | Dim B | Dim C |
|-----|-----------------|-------|-------|-------|
| 2   | XY-GH1.25-2A61  | 1.25  | 3.80  | 5.75  |
| 3   | XY-GH1.25-3A61  | 2.50  | 5.05  | 7.00  |
| 4   | XY-GH1.25-4A61  | 3.75  | 6.30  | 8.25  |
| 5   | XY-GH1.25-5A61  | 5.00  | 7.55  | 9.50  |
| 6   | XY-GH1.25-6A61  | 6.25  | 8.80  | 10.75 |
| 7   | XY-GH1.25-7A61  | 7.50  | 10.05 | 12.00 |
| 8   | XY-GH1.25-8A61  | 8.75  | 11.30 | 13.25 |
| 9   | XY-GH1.25-9A61  | 10.00 | 12.55 | 14.50 |
| 10  | XY-GH1.25-10A61 | 11.25 | 13.80 | 15.75 |
| 11  | XY-GH1.25-11A61 | 12.50 | 15.05 | 17.00 |
| 12  | XY-GH1.25-12A61 | 13.75 | 16.30 | 18.25 |
| 13  | XY-GH1.25-13A61 | 15.00 | 17.55 | 19.50 |
| 14  | XY-GH1.25-14A61 | 16.25 | 18.80 | 20.75 |
| 15  | XY-GH1.25-15A61 | 17.50 | 20.05 | 22.00 |
| 16  | XY-GH1.25-16A61 | 18.75 | 21.30 | 23.25 |

| DIMENSION IN mm |           | TOLERANCE UNLESS OTHERWISE SPECIFIED |  | APR. Alex              |                                    | TITLE: WAFER 1.25mm H4.35mm W/ B 90°SMT |  |
|-----------------|-----------|--------------------------------------|--|------------------------|------------------------------------|---|--|
| .X±0.35         | X.*± 5'   | CHK. Jack                            |  | DWG NO. XY-GH1.25-NA61 |                                    | CUSTOMER DRAWING                        |  |
| .XX±0.25        | .X.*± 3'  | DRA. Can                             |  | PROJ.                  | SIZE A4 SCALE 1:1 SHEET 1/3 REV. A |   |  |
| .XXX±0.15       | .XX.*± 1' |                                      |  |                        |                                    |   |  |

厦门市辛译精密电子有限公司  
Xiamen XinYi Xyecomm Electronics Co.,Ltd

|      |      |          |      |      |
|------|------|----------|------|------|
| REV. | Q'TY | ECN. NO. | APR. | DATE |
|      |      |          |      |      |

A

B

C

D

E

F

A

B

C

D

E

F

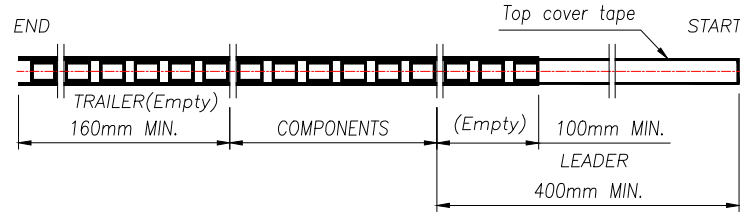

PRELIMINARY DESIGN IS SUBJECT TO CHANGE WITHOUT PRIOR NOTICE

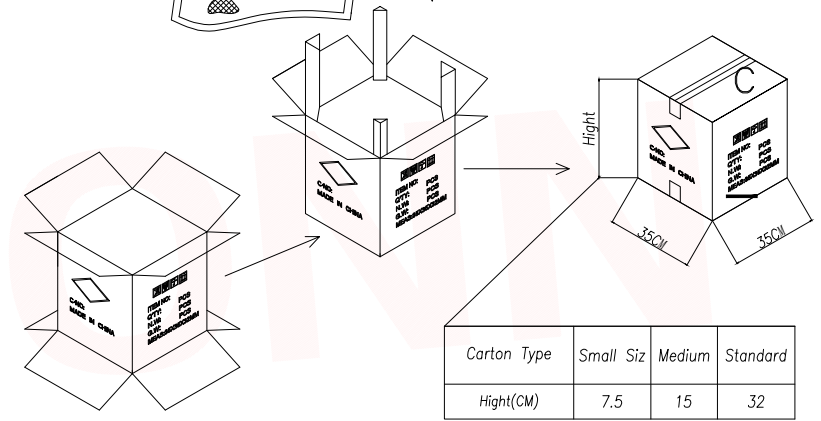
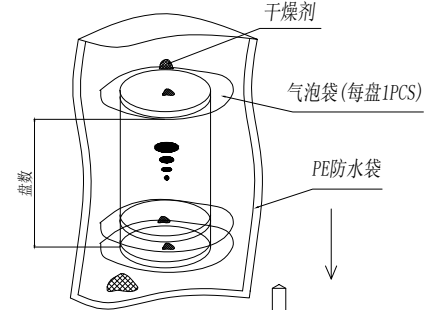
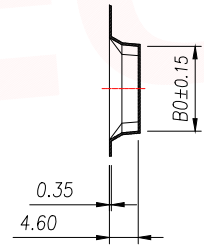
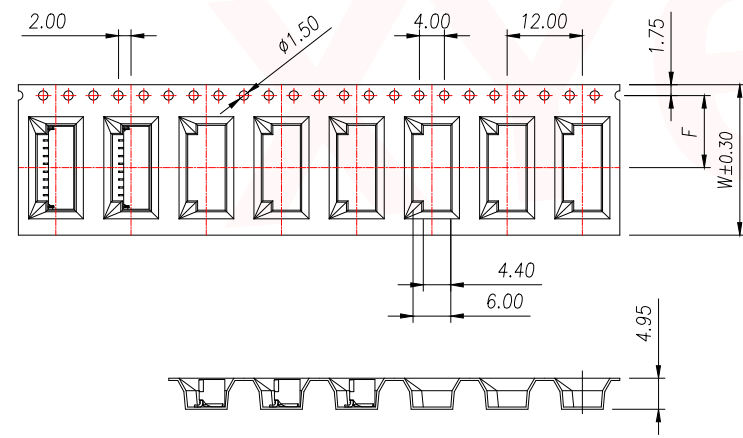
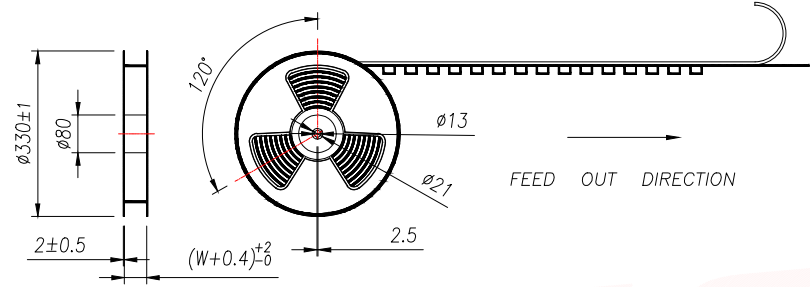

| Carton Type | Small Siz | Medium | Standard |
|-------------|-----------|--------|----------|
| Height(CM)  | 7.5       | 15     | 32       |

- NOTE:
- 1.10 SPROCKET HOLE PITCH CUMULATIVE TOLERANCE ±0.2mm.
  - 2.CARRIER CAMBER NOT TO EXCEED 1mm IN 100mm.
  - 3.ALL DIMENSIONS MEET EIA-481 REQUIREMENTS.
  - 4.MATERIAL: CLEAR ANTISTATIC PS, COLD SEALING.
  - 5.THICKNESS: 0.35±0.05mm.
  - 6.PACKING LENGHT PER REEL: 12.4 METERS.
  - 7.COMPONENT LOAD PER REEL: 1000 PCS.

| PIN | NO.            | Dim B0 | Dim W | Dim F | PCS/RELL | RELL/CARTON | PCS/CARTON |
|-----|----------------|--------|-------|-------|----------|-------------|------------|
| 2   | XY-GH1.25-2A61 | 8.20   | 16    | 7.5   | 1000     | 14          | 14000      |
| 3   | XY-GH1.25-3A61 | 10.20  |       |       |          |             |            |
| 4   | XY-GH1.25-4A61 | 12.20  |       |       |          |             |            |
| 5   | XY-GH1.25-5A61 | 14.20  |       |       |          |             |            |
| 6   | XY-GH1.25-6A61 | 16.20  | 24    | 11.50 | 10       | 10          | 10000      |
| 7   | XY-GH1.25-7A61 | 18.20  |       |       |          |             |            |
| 8   | XY-GH1.25-8A61 | 20.20  |       |       |          |             |            |
| 9   | XY-GH1.25-9A61 | 22.20  |       |       |          |             |            |

| DIMENSION IN mm |           | TOLERANCE UNLESS OTHERWISE SPECIFIED |        | 厦门市辛译精密电子有限公司<br>Xiamen XinYi Xyconn Electronics Co.,Ltd |  |                  |  |
|-----------------|-----------|--------------------------------------|--------|--|--|------------------|--|
| .X±0.35         | X.*± 5°   | APR.                                 | Alex   | TITLE: WAFER 1.25mm H4.35mm W/ B 90°SMT                  |  |                  |  |
| .XX±0.25        | .X*± 3°   | CHK.                                 | Jack   | DWG NO. XY-GH1.25-NA61                                   |  |                  |  |
| .XXX±0.15       | .XX*± 1°  | DRA.                                 | Can    | PROJ.  |  | CUSTOMER DRAWING |  |
| SIZE A4         | SCALE 1:1 | SHEET 2/3                            | REV. A |  |  |                  |  |

