

REV.	Q'TY	ECN. NO.	APR.	DATE

PRELIMINARY
DESIGN IS SUBJECT
TO CHANGE WITHOUT
PRIOR NOTICE

NOTES:

1. Working temp: -25°C~85°C.
2. Voltage rating: 100V AV/DC(rms)
3. Contact resistance: 20mΩ max.
4. Insulation resistance: 1000MΩ min.
5. Current rating: 2A AV/DC
6. Withstanding Voltage: 800V AC/minute
7. Pin Retention Force: 15N min.
8. Housing material: LCP UL94-V0, Natural
9. Terminal materl: Brass,
plating Ni 50u" min , plating Tin 100u"min.
10. Solder tab material: Brass,
plating Ni 50u" min , plating Tin 100u"min.

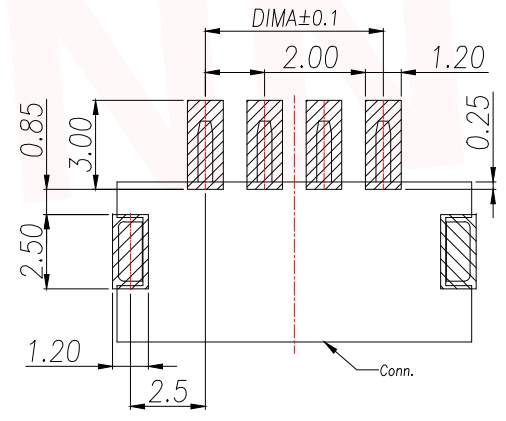
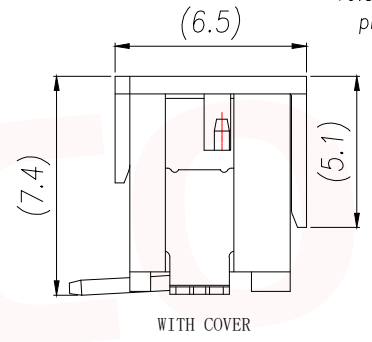
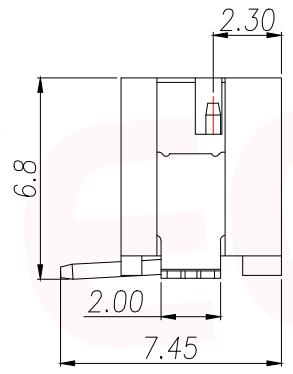
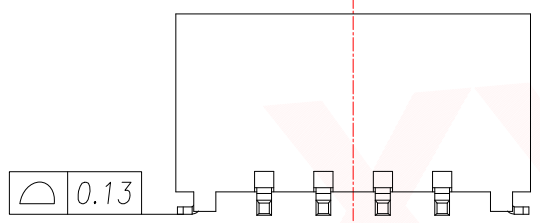
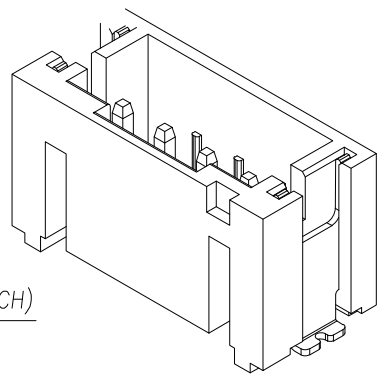
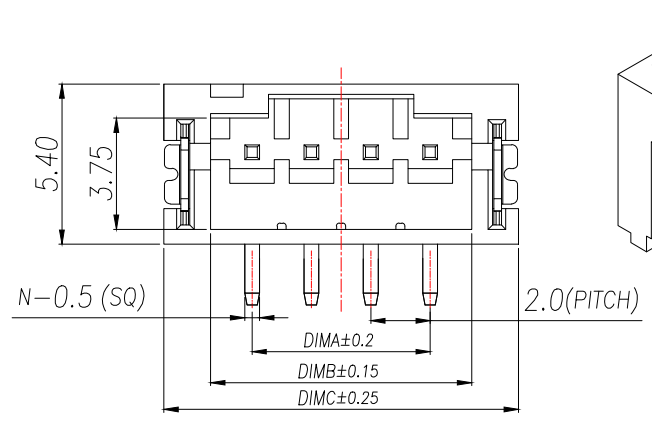

RECOMMENDED PCB LAYOUT TOP VIEW (TOLERANCE: ±0.05)

▨ SMT SOLDER AREA

PIN	NO.	Dim A	Dim B	Dim C
2	XY-PH2.0-2A51	2.00	4.80	7.95
3	XY-PH2.0-3A51	4.00	6.80	9.95
4	XY-PH2.0-4A51	6.00	8.80	11.95
5	XY-PH2.0-5A51	8.00	10.80	13.95
6	XY-PH2.0-6A51	10.00	12.80	15.95
7	XY-PH2.0-7A51	12.00	14.80	17.95
8	XY-PH2.0-8A51	14.00	16.80	19.95
9	XY-PH2.0-9A51	16.00	18.80	21.95
10	XY-PH2.0-10A51	18.00	20.80	23.95
11	XY-PH2.0-11A51	20.00	22.80	25.95
12	XY-PH2.0-12A51	22.00	24.80	27.95
13	XY-PH2.0-13A51	24.00	26.80	29.95
14	XY-PH2.0-14A51	26.00	28.80	31.95
15	XY-PH2.0-15A51	28.00	30.80	33.95
16	XY-PH2.0-16A51	30.00	32.80	35.95

DIMENSION IN mm		TOLERANCE UNLESS OTHERWISE SPECIFIED		厦门市辛译精密电子有限公司 Xiamen XinYi Xyconn Electronics Co.,Ltd	
.X±0.35	.X*± 5°	APR.	Alex	TITLE: WAFER 2.00mm H6.8mm 180°SMT	
.XX±0.25	.X*± 3°	CHK.	Jack	DWG NO. XY-PH2.0-NA51	
.XXX±0.15	.XX*± 1°	DRA.	Can	PROJ. CUSTOMER DRAWING	
		SIZE	A4	SCALE	1:1
		SHEET	1/3	REV.	A

REV.	Q'TY	ECN. NO.	APR.	DATE

PRELIMINARY
DESIGN IS SUBJECT
TO CHANGE WITHOUT
PRIOR NOTICE

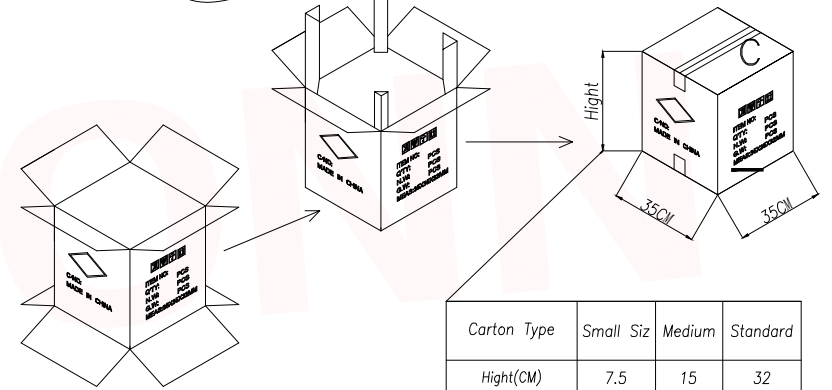
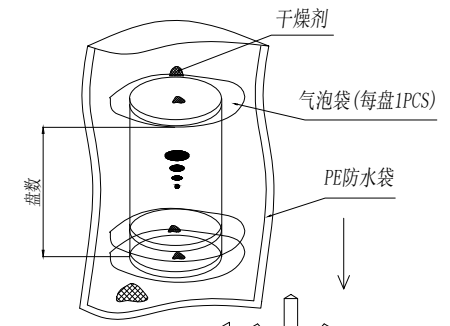
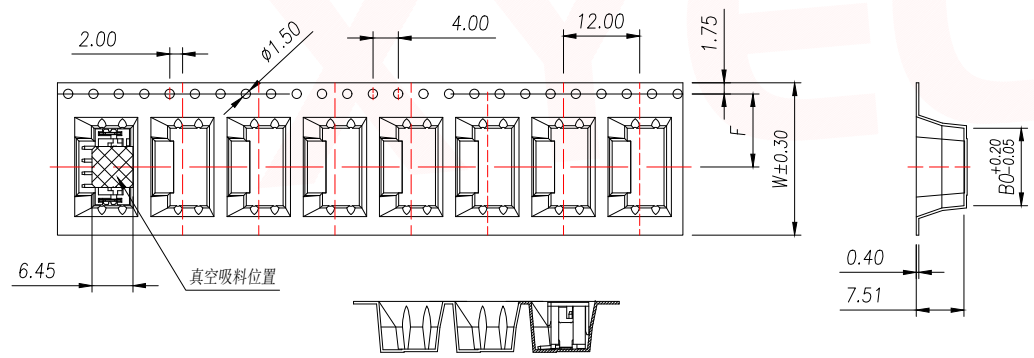
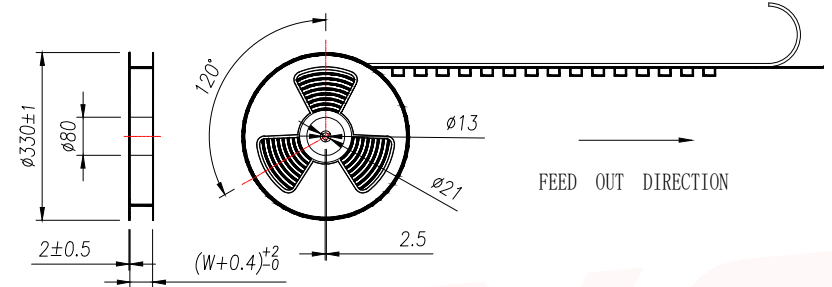
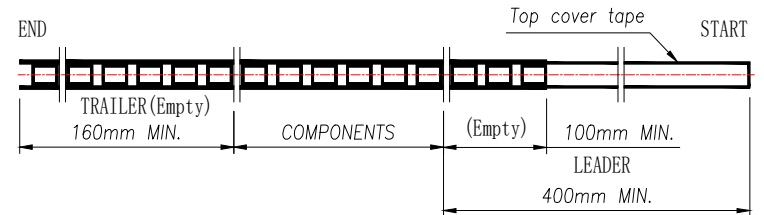

Carton Type	Small Siz	Medium	Standard
Height(CM)	7.5	15	32

- NOTE:
- 1.10 SPROCKET HOLE PITCH CUMULATIVE TOLERANCE ±0.2mm.
 - 2.CARRIER CAMBER NOT TO EXCEED 1mm IN 100mm.
 - 3.ALL DIMENSIONS MEET EIA-481 REQUIREMENTS.
 - 4.MATERIAL: CLEAR ANTISTATIC PS, COLD SEALING.
 - 5.THICKNESS: 0.40±0.05mm.
 - 6.PACKING LENGTH PER REEL: 8.8 METERS.
 - 7.COMPONENT LOAD PER REEL: 700 PCS.

PIN	NO.	Dim BO	Dim W	Dim F	PCS/RELL	RELL/CARTON	PCS/CARTON
2	XY-PH2.0-2A51	8.20	16	7.5	700	14	9800
3	XY-PH2.0-3A51	10.20	24	11.50		10	7000
4	XY-PH2.0-4A51	12.20					
5	XY-PH2.0-5A51	14.20					

DIMENSION IN mm		厦门市辛译精密电子有限公司 Xiamen XinYi Xyconn Electronics Co.,Ltd			
TOLERANCE UNLESS OTHERWISE SPECIFIED					
.X±0.35	X.*±5°	APR.	Alex	TITLE: WAFER 2.00mm H6.8mm 180°SMT	
.XX±0.25	.X.*±3°	CHK.	Jack	DWG NO. XY-PH2.0-NA51	
.XXX±0.15	.XX.*±1°	DRA.	Can	PROJ. CUSTOMER DRAWING	
		SIZE A4	SCALE 1:1	SHEET 2/3	REV. A

