

1A, 1MHz, Synchronous Step-Up DC-DC Converter

UM3430AS SOT23-6

UM3430ADA DFN6 2.0×2.0

General Description

The UM3430A is a synchronous rectified, fixed frequency, step-up DC/DC converter delivering high efficiency in low profile SOT23-6 and DFN6 2.0×2.0 packages. The device features true output load disconnection and adjustable output with a current limit of 1A. With an internal NMOS switch, PMOS synchronous rectifier and high switching frequency of 1MHz, the UM3430A is capable of supplying 5.0V output at 500mA from single Li-ion cell or 300mA from 2 cell AA input using low profile inductors and ceramic capacitors. Current mode PWM control with internal compensation as well as the synchronous rectifier and 1MHz high frequency lead to the fewest number of external parts needed thereby saving BOM cost and PCB area. At light load, UM3430A enters automatically into pulse skipping mode to keep high efficiency. An internal dumping circuit will be connected to V_{IN} when the switch is idle that eliminates switch ringing and reduces EMI interference. Minimum V_{IN} operation after start-up is only limited by the battery's ability to provide the necessary power as it enters a deeply discharge state. The device also features low shutdown current less than 1 μ A. It also limits the inductor current below to 500mA during start-up, minimizing surge currents seen by the input supply.

Applications

- Compact Solution for 5V USB On-The-Go V_{BUS} Power
- Digital Cameras
- Handheld Instruments
- Wireless Handsets
- GPS Receivers
- Medical Instruments

Features

- 5V at 500mA from single Li-Ion Cell
- Up to 94% Efficiency
- Output Load Disconnection
- Internal Synchronous Rectifier
- Input Current Limit 1A
- Pulse Skipping Mode Operation with Typical I_Q as 48 μ A
- Shutdown Current Lower than 1 μ A
- 1MHz Switching Frequency for Low Profile Inductor/Capacitor
- Minimum Start-Up Voltage: 2.3V
- Output Voltage: 2.5V to 5V
- Anti-Ringing Control to Reduce EMI

Typical Application Circuit

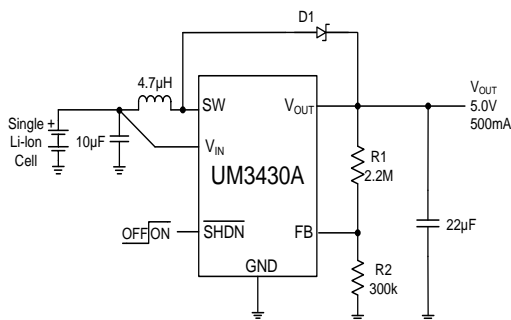

Efficiency vs. Output Current (Li-Ion to 5V)

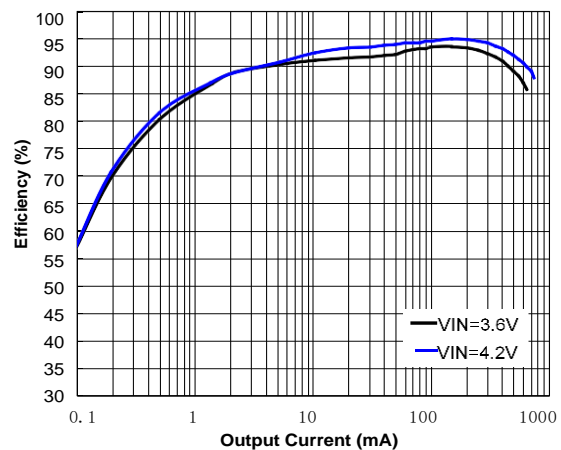

Pin Configurations

Top View

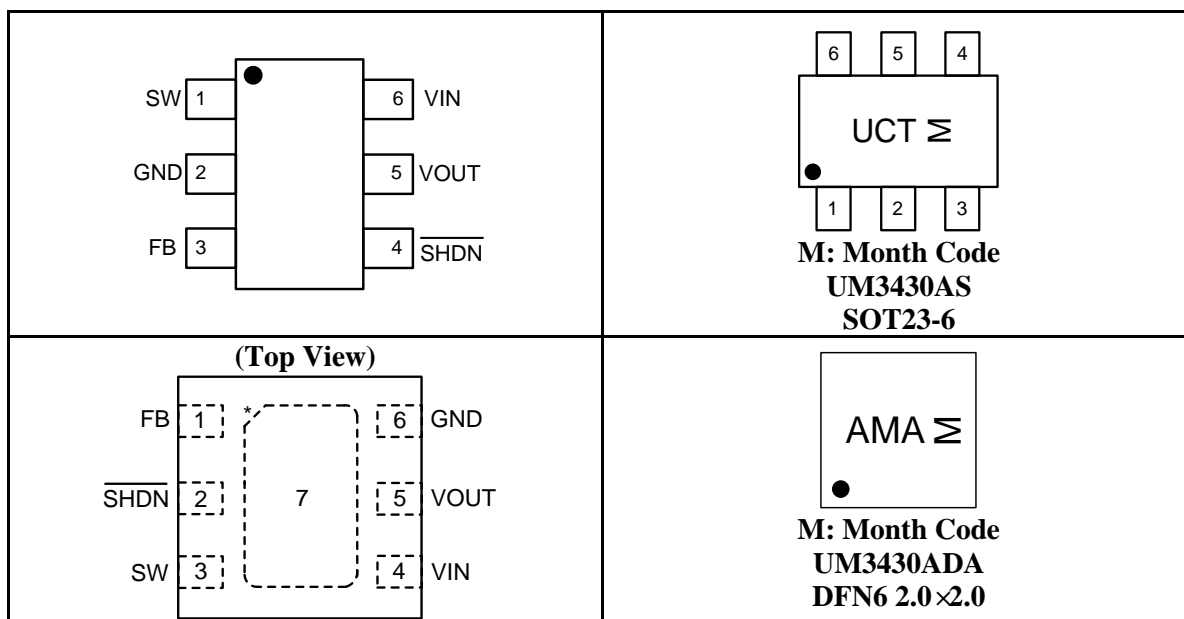

Pin Description

Pin Number		Symbol	Description
UM3430AS	UM3430ADA		
1	3	SW	Switch Pin. Connect external inductance to V_{IN} . Keep these PCB trace lengths as short and wide as possible.
2	6	GND	Ground. Provide a short direct PCB path between GND and the negative electrode of C_{OUT} and C_{IN} .
3	1	FB	Feedback Input Pin. Connect to the center point of the external resistor divider and set the output voltage by: $V_{OUT} = 0.6V \left(1 + \frac{R1}{R2} \right)$
4	2	\overline{SHDN}	Logic Controlled Shutdown Input. Low logic active. In shutdown mode, all functions are disabled drawing $<1\mu A$ supply current. Do not leave SHDN floating.
5	5	VOUT	Output Voltage Sense Input and Drain of the Internal Synchronous Rectifier P-MOSFET. Bias is derived from V_{OUT} . Keep PCB trace length from V_{OUT} to the output filter capacitor(s) as short and wide as possible.
6	4	VIN	Battery Input Voltage. The device gets its start-up bias from V_{IN} . Once V_{OUT} exceeds V_{IN} , bias comes from V_{OUT} . Thus, once started, operation is completely independent from V_{IN} . Operation is only limited by the output power level and the battery's internal series resistance.
-	7	Exposed Pad	The exposed pad must be soldered to the PCB ground plane. It serves as an additional ground connection and as a means of conducting heat away from the package.

Ordering Information

Part Number	Packaging Type	Marking Code	Shipping Qty
UM3430AS	SOT23-6	UCT	3000pcs/7Inch Tape & Reel
UM3430ADA	DFN6 2.0×2.0	AMA	

Absolute Maximum Ratings (Note 1)

Symbol	Parameter	Value	Unit
V_{IN}	V_{IN} Supply Voltage	-0.3 to +6.0	V
V_{SW}	SW Voltage	-0.3 to +6.0	V
V_{FB}	FB Voltage	-0.3 to +6.0	V
$V_{\overline{SHDN}}$	\overline{SHDN} Voltage	-0.3 to +6.0	V
V_{OUT}	Output Voltage	-0.3 to +6.0	V
T_{OP}	Operating Ambient Temperature Range	-40 to +85	°C
T_{STG}	Storage Temperature Range	-65 to +150	°C
T_L	Maximum Lead Temperature (Soldering , 10s)	+260	°C

Note 1: Maximum ratings are those values beyond which device damage can occur. Maximum ratings applied to the device are individual stress limit values (not normal operating conditions) and are not valid simultaneously. If these limits are exceeded, device functional operation is not implied, damage may occur and reliability may be affected.

Electrical Characteristics

($V_{IN}=3.6V$, $V_{OUT}=5V$, $T_A=+25\text{ }^\circ\text{C}$, unless otherwise noted.)

Parameter	Test Conditions	Min	Typ	Max	Unit
Minimum Start-up Voltage	$I_{LOAD}=100\text{mA}$, $V_{OUT}=0V$		2.1	2.3	V
Minimum Operating Voltage	$I_{LOAD}=100\text{mA}$ (Note 2)		1.2		V
Maximum Input Voltage		5.4			V
Adjustable Output Voltage Range		2.5		5.25	V
Feedback Voltage		0.588	0.6	0.612	V
Feedback Input Current	$V_{FB}=0.6V$		1	50	nA
Quiescent Current (Pulse Skipping Mode)	$V_{FB}=0.7V$, $V_{IN}=\overline{\text{SHDN}}$ (Note 3)		48		μA
Quiescent Current (Normal)	$V_{FB}=0.5V$, $V_{IN}=\overline{\text{SHDN}}$ (Note 3)		2.5		mA
Quiescent Current (Shutdown)	$\overline{\text{SHDN}}=0V$			1	μA
NMOS Leakage Current	$V_{SW}=5V$		0.1	5	μA
PMOS Leakage Current	$V_{SW}=5V$, $V_{OUT}=0V$		0.1	5	μA
NMOS On-Resistance			0.25		Ω
PMOS On-Resistance			0.35		Ω
NMOS Current limit		900	1000	1200	mA
Pulse Skipping Mode Operation Current Threshold	$L=4.7\text{ }\mu\text{H}$		40		mA
Max Duty Cycle		80	90		%
Switching Frequency		0.8	1	1.2	MHz
$\overline{\text{SHDN}}$ Input High		2			V
$\overline{\text{SHDN}}$ Input Low				0.8	V
$\overline{\text{SHDN}}$ Input Current	$\overline{\text{SHDN}}=5.5V$		0.01	1	μA
Soft-Start Time	$\overline{\text{SHDN}}$ to 90% of V_{OUT}		1		ms

Note 2: Minimum V_{IN} operation after start-up is only limited by the battery's ability to provide the necessary power as it enters a deeply discharged state.

Note 3: Pulse skipping mode and normal operation I_Q is measured at V_{OUT} . The chip is in the open loop status and the inductor should not be soldered.

Typical Operating Characteristics

($C_{IN}=10\mu F$, $C_{OUT}=22\mu F$, $L=4.7\mu H$, $T_A=25\text{ }^\circ\text{C}$, unless otherwise specified)

**Efficiency vs. Output Current
(2 Cell to 3.3V)**

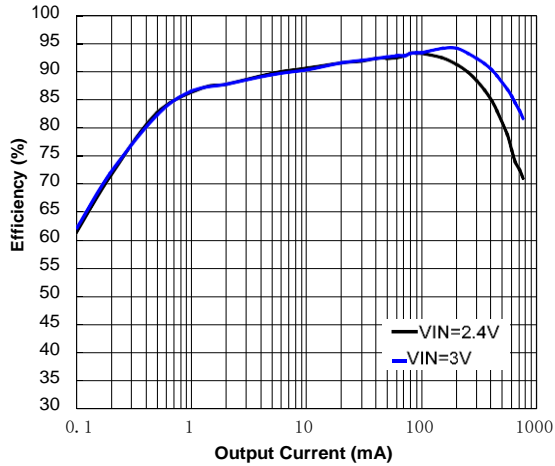

**Efficiency vs. Output Current
(2 Cell to 5V)**

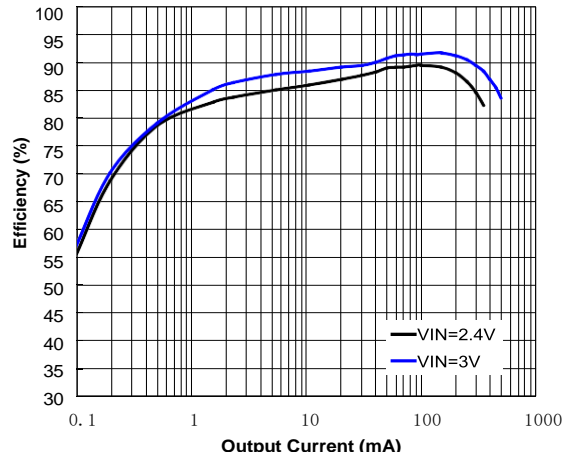

**Efficiency vs. Output Current
(Li-Ion to 5V)**

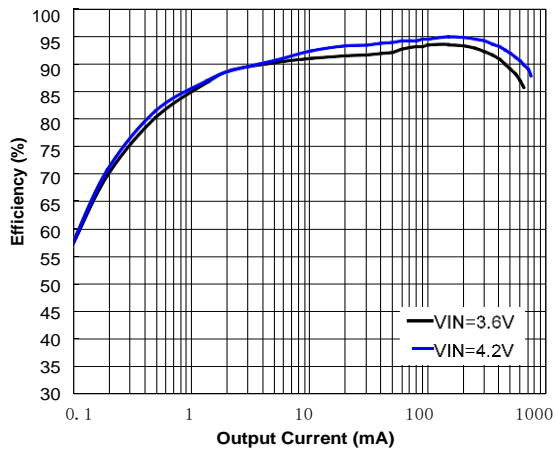

**Efficiency vs. Input Voltage
(VOUT=3.3V)**

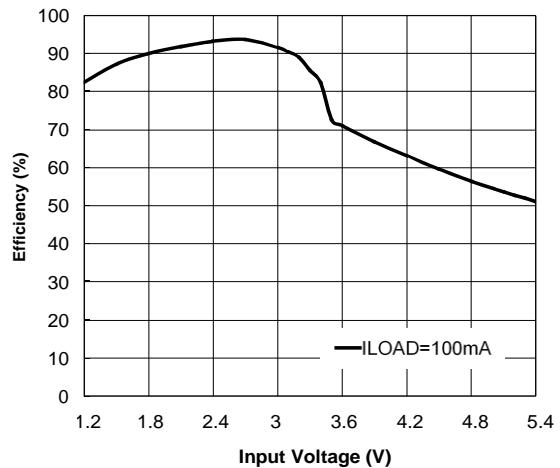

**Efficiency vs. Input Voltage
(VOUT=5V)**

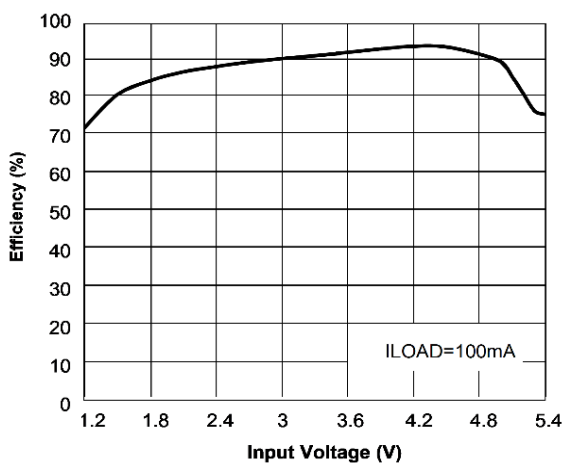

**Maxim Load Current vs. Input Voltage
@Vout Derate 4%**

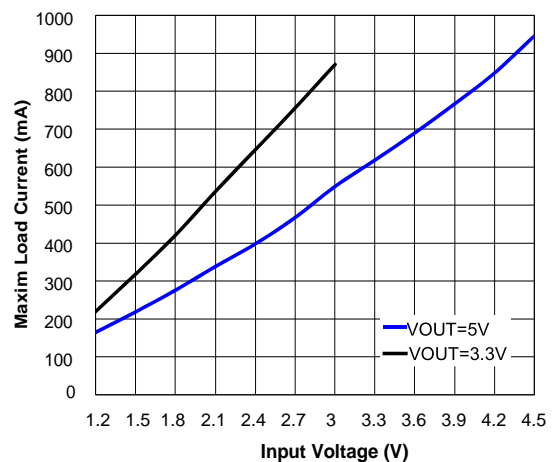

Typical Operating Characteristics (Continued)

($C_{IN}=10\mu F$, $C_{OUT}=22\mu F$, $L=4.7\mu H$, $T_A=25\text{ }^\circ\text{C}$, unless otherwise specified)

Pulse Skipping Mode Output Current Threshold vs. Input Voltage

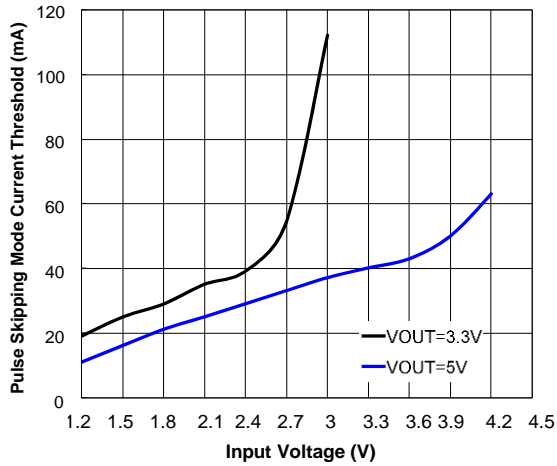

No Load Input Current vs. Input Voltage (Note 4)

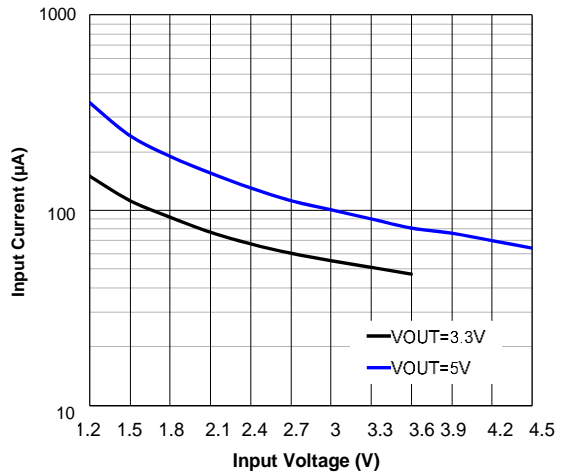

Output Voltage vs. Temperature @ ILOAD=100mA

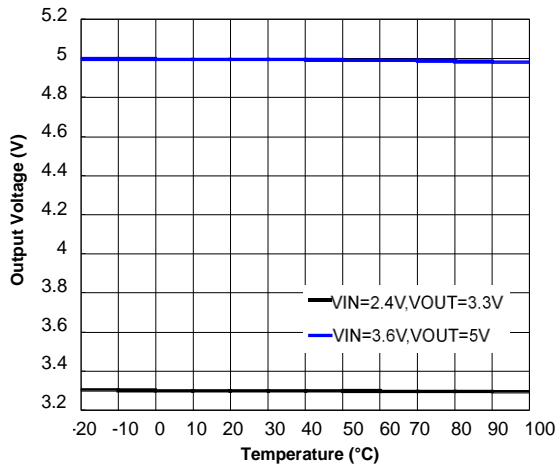

Pulse Skipping Mode Quiescent Current vs. Temperature (Note 4)

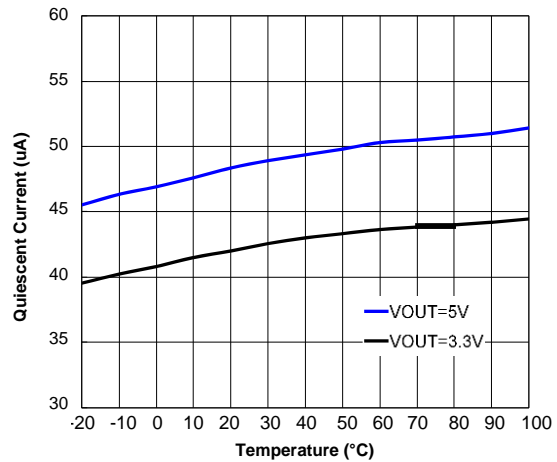

Note 4: No load input Current is measured at V_{IN} and Pulse Skipping Mode Quiescent Current is measured at V_{OUT} .

Typical Operating Characteristics (Continued)

($V_{IN}=3.6V$, $V_{OUT}=5V$, $C_{IN}=10\mu F$, $C_{OUT}=22\mu F$, $L=4.7\mu H$, $T_A=25\text{ }^\circ C$, unless otherwise specified)

SW Pin Normal Mode Operation

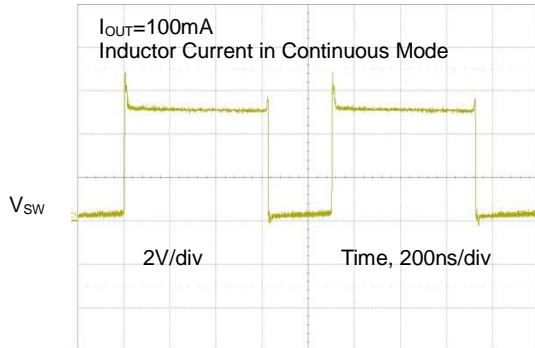

SW Pin Anti-Ringing Operation

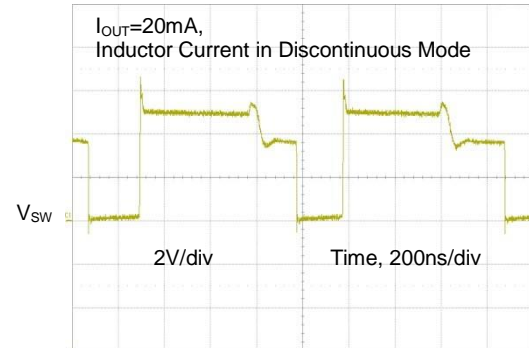

Inrush Current Control and Soft Start

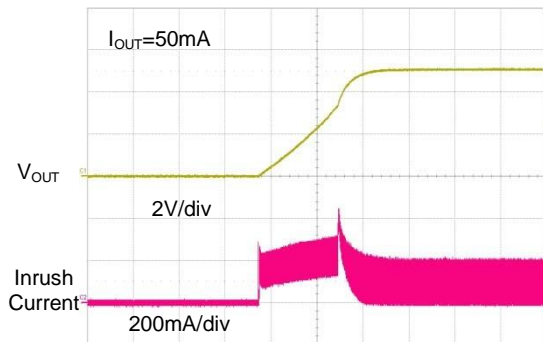

Load Transient Response

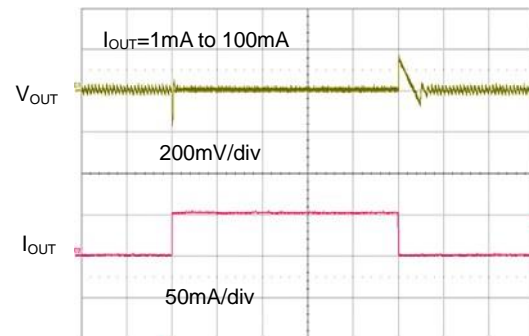

Pulse Skipping Mode Ripple

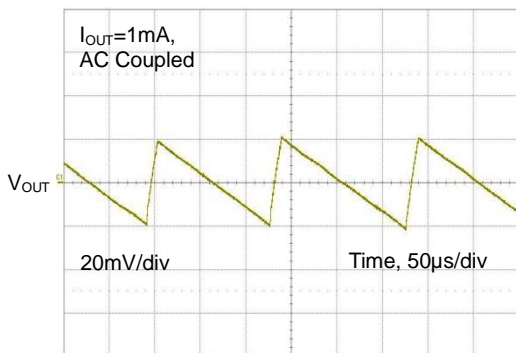

Ripple and Noise

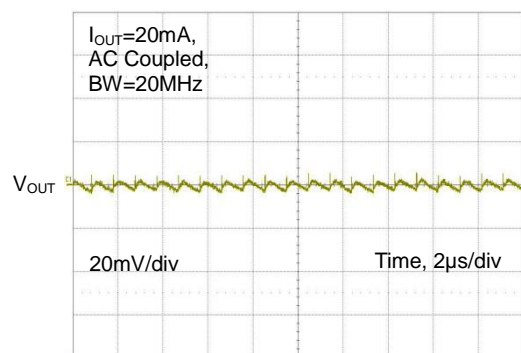

Ripple and Noise

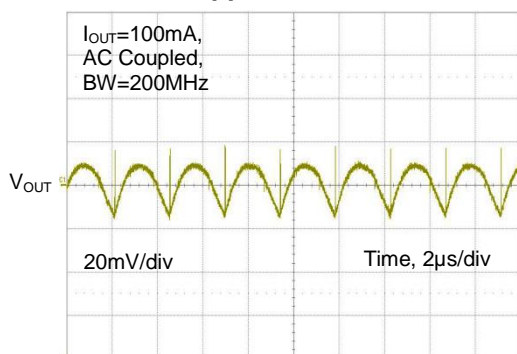

Ripple and Noise

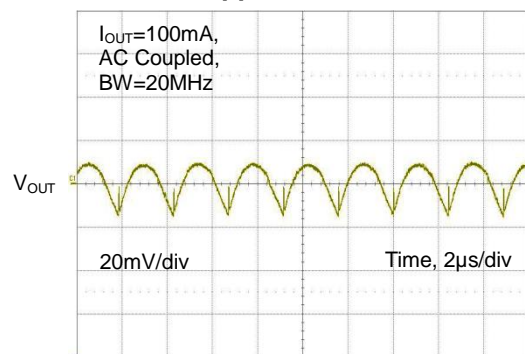

Block Diagram

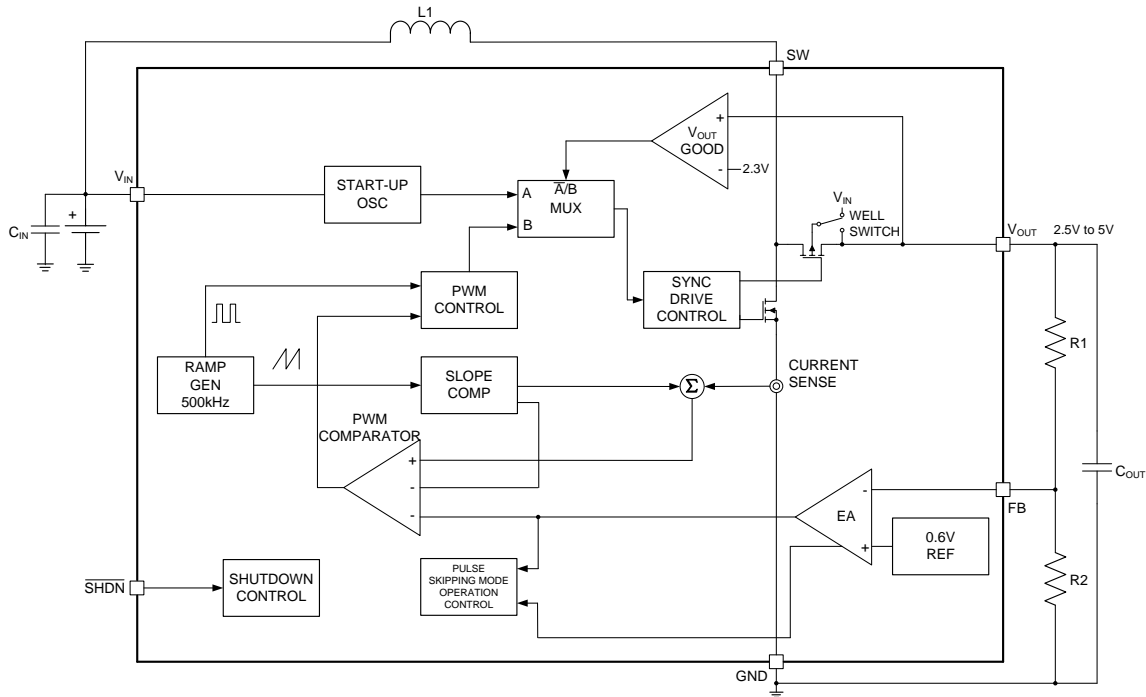

Typical Application

Applications Where $V_{OUT} > 4.3V$

When the output voltage is programmed above 4.3V, it is necessary to add a Schottky diode either from SW to VOUT in order to maintain an acceptable peak voltage on the SW pin. The Schottky diode between SW and VOUT will provide a peak efficiency improvement.

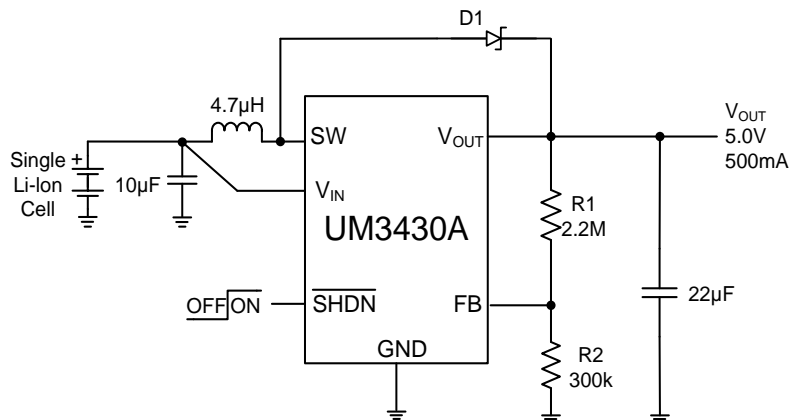

Function Description

The UM3430A is synchronous rectified, 1MHz fixed frequency, step-up DC/DC converter in low profile SOT23-6 and DFN6 2.0×2.0 packages. The device features low $R_{DS(ON)}$ internal MOSFET switches, current mode PWM controller and 0.6V internal reference voltage. Refer to the Block Diagram for better understanding.

Start-up

The device gets its start-up bias from V_{IN} . Once V_{OUT} exceeds V_{IN} , bias comes from V_{OUT} . The soft-start time is typically 1ms. To minimize the inrush current, the chip is in the open loop operation in this status and the peak switch current is limited below to 500mA independent of input or output voltage.

NMOS Current Limit

The internal NMOS turns off while the inductor current reaches the current limit (I_{LIM}) typically 1000mA. There is approximately a 100ns delay from the time the current limit is reached and when the internal logic actually turns off the switch. During this 100ns delay, the peak inductor current will increase. It can be approximated by the following equation:

$$I_{peak(typ)} = I_{LIM} + \frac{V_{IN}}{L} \times 100ns$$

This leads to the demand of a larger saturation current rating for the inductor.

Anti-Ringing Control

An internal dumping circuit will be connected from SW to V_{IN} to damp resonant circuit formed by L and C_{SW} when the inductor current is in the discontinuous mode. That eliminates switch ringing and reduces EMI interference.

Pulse Skipping Mode Operation

At very light loads, the UM3430A automatically enters Pulse Skipping Mode. In the Pulse Skipping Mode, the inductor current may reach zero or reverse on each pulse. The PWM control loop will automatically skip pulses to maintain output regulation. That improves the efficiency of the converter and saves energy of the battery.

Output Disconnection

The UM3430A is designed to allow true output disconnection by eliminating body diode conduction of the internal PMOS rectifier. This allows V_{OUT} to go to 0V during shutdown, drawing zero current from the input source. This function is realized by the well switch that connects the substrate to V_{IN} . Please refer to the Block Diagram for better understanding.

$V_{IN} > V_{OUT}$ Operation

The UM3430A will maintain voltage regulation even if the input voltage is above the output voltage. Since the PMOS no longer acts as a low impedance switch in this mode, there will be more power dissipation within the IC. This will cause a sharp drop in the efficiency (see Typical Operating Characteristics, Efficiency vs. Input Voltage). The maximum output current should be limited in order to maintain an acceptable junction temperature, 100mA is usually acceptable.

Applications Information

Output Voltage Setting

The external resistor divider sets the output voltage. Choose R2 around 300k Ω for optimal transient response and feedback leakage current. V_{OUT} is set by:

$$V_{OUT}=0.6V\left(1+\frac{R1}{R2}\right)$$

Inductor Selection

A 2.2µH to 4.7µH inductor with DC current rating at least 1.5A is recommended for most applications of UM3430A.

Larger values of inductance will allow greater output current capability by reducing the inductor ripple current. Increasing the inductance above 6.8µH will increase size while providing little improvement in output current capability.

For best efficiency, the inductor DC resistance shall be as small as possible to reduce the I^2R power losses. As the switching frequency is up to 1MHz, inductor losses are closely related to the magnetic core materials. High frequency ferrite core inductors are preferred to comparatively cheap powdered iron core ones. To minimize radiated noise, use a toroid, pot core or shielded bobbin inductor. See Table 1 for some suggested inductors and suppliers.

Table 1. Recommended Inductors

Part	L (µH)	Max DCR (mΩ)	Height (mm)	Supplier
74404041047	4.7	91	1.2	Würth Elektronik www.we-online.com
CDRH5D16NP	4.7	64	1.8	Sumida www.sumida.com
VLF5014S	4.7	98	1.4	TDK www.component.tdk.com
MSS6122	4.7	65	2.2	Coilcraft www.coilcraft.com

Input and Output Capacitor Selection

Low ESR capacitors should be used to minimize the output voltage ripple, input switching noise and the peak current drawn from the battery. Multilayer ceramic capacitors are an excellent choice as they have extremely low ESR and are available in small footprints. X5R and X7R dielectric materials are recommended.

A 10µF input capacitor and a 22µF output capacitor is sufficient for most applications of UM3430A. At the application that the maximum output current is less than 300mA, a 4.7µF input capacitor and a 10µF output capacitor is feasible. To minimize the output voltage ripple and improve the transient response, an larger input and output capacitor can be used. Table 2 below shows a list of several ceramic capacitor suppliers.

Table 2. Recommended Capacitor Suppliers Information

Supplier	Website
AVX	www.avxcorp.com
Murata	www.murata.com
Fenghua	www.china-fenghua.com
Samsung Electro-Mechanics	www.samsungsem.com

Layout Guidance

When laying out the PC board, the following suggestions should be taken to ensure proper operation of the UM3430A.

1. Consideration should be taken first to place C_{OUT} as closely as possible to the V_{OUT} and GND

pins.

2. The power traces, including the GND, SW, V_{IN} and V_{OUT} should be kept short, direct and wide to allow large current flow.
3. Connect the input capacitor C_{IN} to the GND pin as closely as possible to get good power filter effect and reduce ground bounce.
4. Keep the switching node away from the sensitive FB node.
5. Do not trace signal line under inductor.
6. Keep the GND plane under the converter as complete as possible in double-sided PCB board.
7. For the UM3430ADA, connect pin 4, 8 and the expose pad together to the ground plane by vias to conduct the heat away from the package.

Package Information

UM3430AS: SOT23-6

Outline Drawing

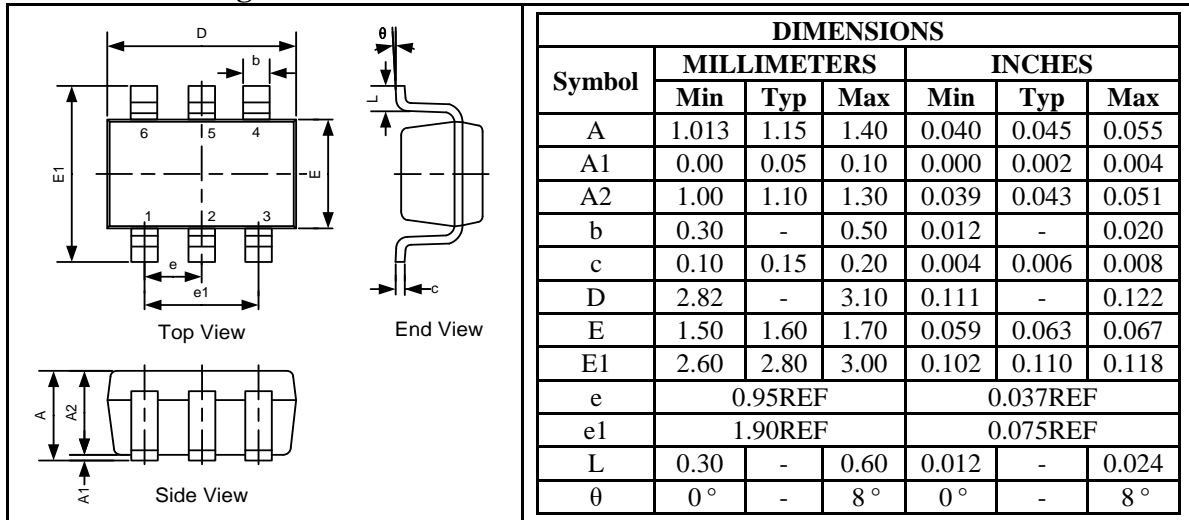

Land Pattern

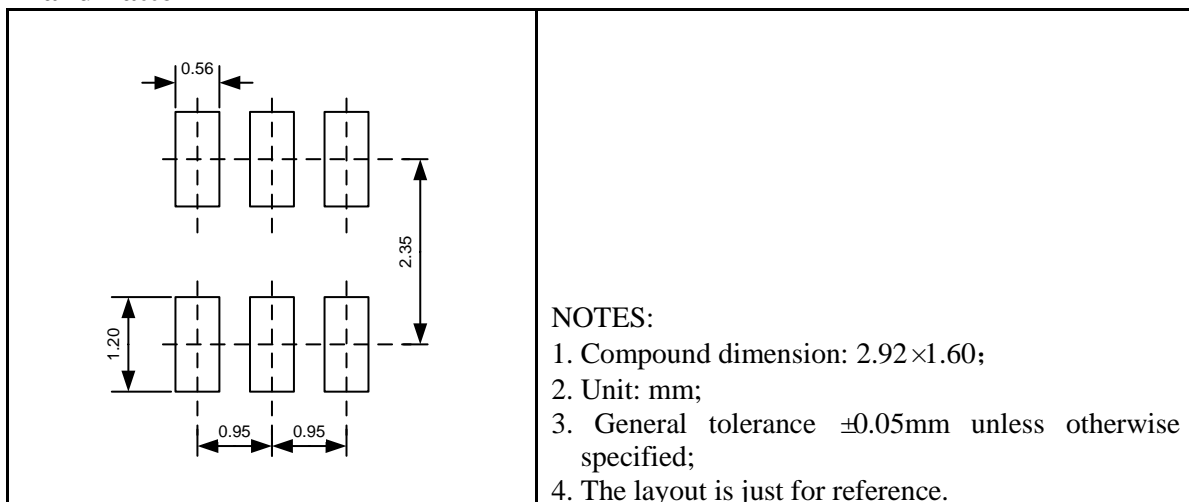

Tape and Reel Orientation



UM3430ADA: DFN6 2.0x2.0

Outline Drawing

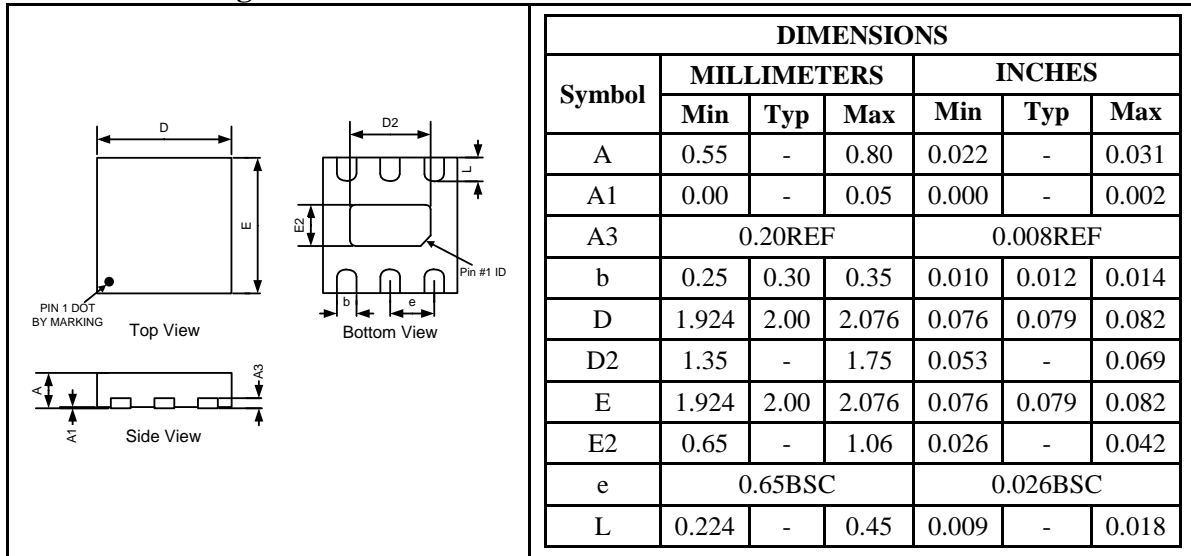

Land Pattern

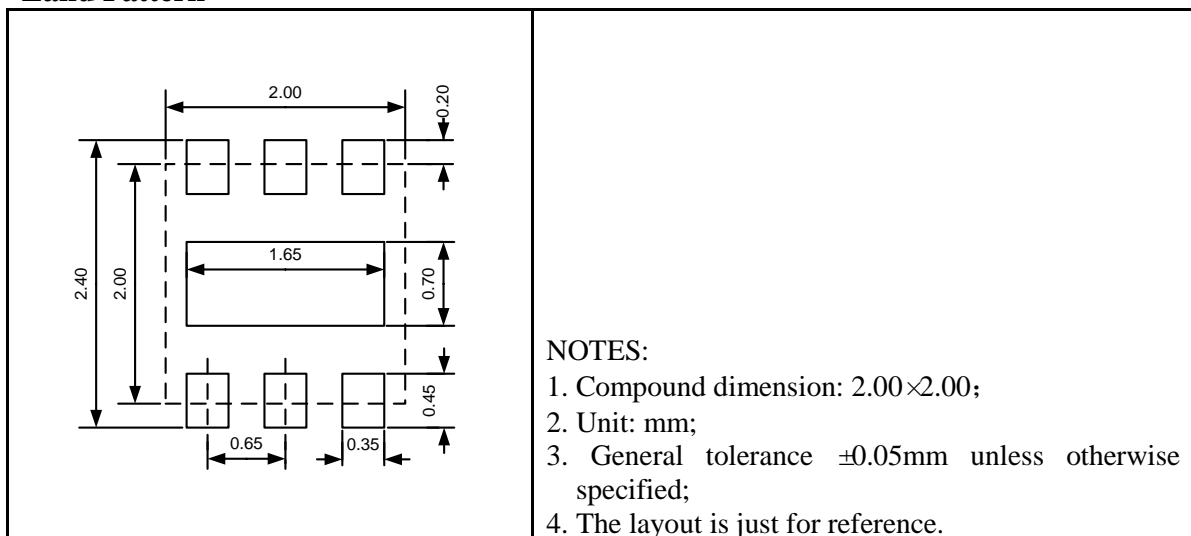

Tape and Reel Orientation



GREEN COMPLIANCE

Union Semiconductor is committed to environmental excellence in all aspects of its operations including meeting or exceeding regulatory requirements with respect to the use of hazardous substances. Numerous successful programs have been implemented to reduce the use of hazardous substances and/or emissions.

All Union components are compliant with the RoHS directive, which helps to support customers in their compliance with environmental directives. For more green compliance information, please visit:

http://www.union-ic.com/index.aspx?cat_code=RoHSDeclaration

IMPORTANT NOTICE

The information in this document has been carefully reviewed and is believed to be accurate. Nonetheless, this document is subject to change without notice. Union assumes no responsibility for any inaccuracies that may be contained in this document, and makes no commitment to update or to keep current the contained information, or to notify a person or organization of any update. Union reserves the right to make changes, at any time, in order to improve reliability, function or design and to attempt to supply the best product possible.



Union Semiconductor, Inc

Add: Unit 606, No.570 Shengxia Road, Shanghai 201908

Tel: 021-51093966

Fax: 021-51026018

Website: www.union-ic.com