

20V P-Channel Power MOSFET

UM2301S SOT23-3
UM2301P SOT323

General Description

The UM2301 is a low threshold P-channel MOSFET, have extremely low on-resistance. This benefit provides the designer with an extremely efficient device for use in battery and load management applications. The device uses a space-saving, small-outline SOT23-3 or SOT323 package.

Applications

- Battery Packs
- Battery-Powered Portable Equipments
- Cellular and Cordless Telephones

Features

- Drain-Source Voltage (Max): -20V
- Low On-Resistance:
200mΩ@V_{GS}=-4.5V
250mΩ@V_{GS}=-2.5V
- Continuous Drain Current (Max) :
-1.5A@25°C (SOT23-3)
-1.1A@25°C (SOT323)

Pin Configurations

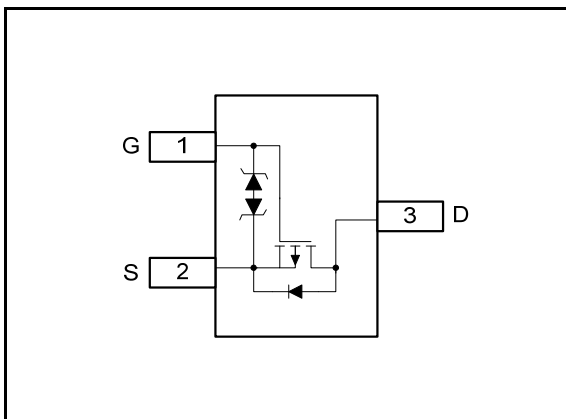

Top View

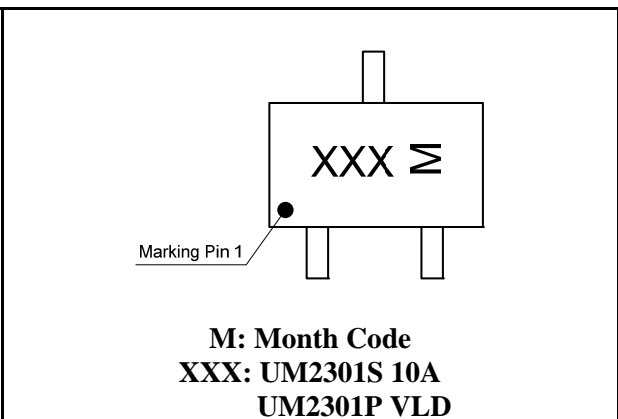

Ordering Information

Part Number	Packaging Type	Marking Code	Shipping Qty
UM2301S	SOT23-3	10A	3000pcs/7 Inch Tape & Reel
UM2301P	SOT323	VLD	

Absolute Maximum Ratings

Symbol	Parameter	Value	Unit
V_{DSS}	Drain-Source Voltage	-20	V
V_{GS}	Gate-Source Voltage	± 8	V
I_D	Continuous Drain Current (5s)	SOT23-3	-1.5
		SOT323	-1.1
I_{DP}	Drain Current Pulsed (Pulse Width $\leq 10\mu s$, Duty Cycle $\leq 1\%$)	-5	A
P_D	Power Dissipation	SOT23-3	0.86
		SOT323	0.5
T_J	Junction Temperature	-55~150	$^{\circ}C$
T_{STG}	Storage Temperature	-55~150	$^{\circ}C$
$R_{\theta JA}$	Thermal Resistance, Junction-to-Ambient ($\leq 5s$)	SOT23-3	145
		SOT323	250
ESD	ESD Method 3015.8	2000	V

Electrical Characteristics ($T_J=25^{\circ}C$, unless otherwise noted)

Symbol	Parameter	Test Condition	Min	Typ	Max	Unit
Off Characteristics						
BV_{DSS}	Drain-to-Source Breakdown Voltage	$V_{GS}=0V, I_D=-250\mu A$	-20			V
I_{DSS}	Zero Gate Voltage Drain Current	$V_{DS}=-20V, V_{GS}=0V$			-0.1	μA
I_{GSS}	Gate-to-Source Leakage Current	$V_{GS}=\pm 8V, V_{DS}=0V$			± 10	μA
On Characteristics						
$R_{DS(ON)}$	Static Drain-to-Source On-Resistance (Note 1)	$V_{GS}=-4.5V, I_D=-1.0A$		200	350	m Ω
		$V_{GS}=-2.5V, I_D=-1.0A$		250	400	
$V_{GS(TH)}$	Gate-Source Threshold Voltage	$V_{DS}=V_{GS}, I_D=-250\mu A$	-0.4	-0.6	-1	V
g_{fs}	Forward Transconductance (Note 1)	$V_{DS}=-5V, I_D=-2.0A$		4.5		S
Dynamic Characteristics (Note 2)						
C_{iss}	Input Capacitance	$V_{GS}=0V, V_{DS}=-10V, f=1.0MHz$		405		pF
C_{oss}	Output Capacitance			150		
C_{rss}	Reverse Transfer Capacitance			55		
Switching Characteristics (Note 2)						
$t_{d(on)}$	Turn-on Delay Time	$V_{DD}=-10V, R_L=10\Omega, I_D=-1A, V_{GEN}=-4.5V, R_G=1\Omega$		11	20	ns
t_r	Rise Time			35	60	
$t_{d(off)}$	Turn-off Delay Time			80	150	
t_f	Fall Time			50	90	
Drain-Source Diode Characteristics and Maximum Ratings						
V_{SD}	Forward Diode Voltage	$I_S=-0.7A$		-0.8	-1.2	V

Note 1: Pulse test: pulse width $\leq 300\mu s$, duty cycle $\leq 2\%$.

Note 2: Guaranteed by design, not subject to production testing.

Typical Characteristics ($T_J=25^\circ\text{C}$, unless otherwise noted)

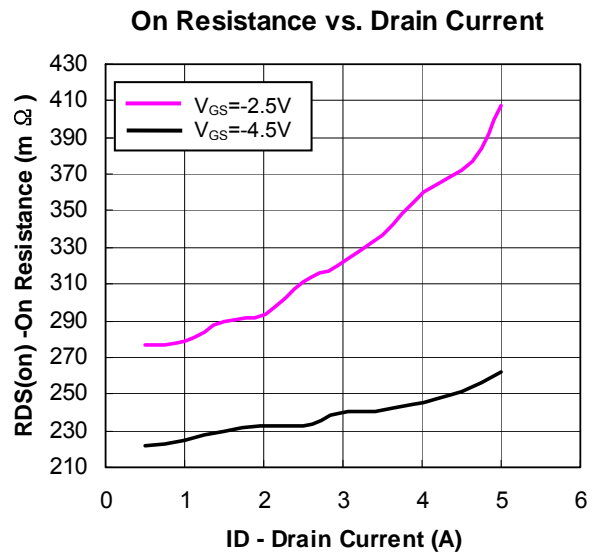
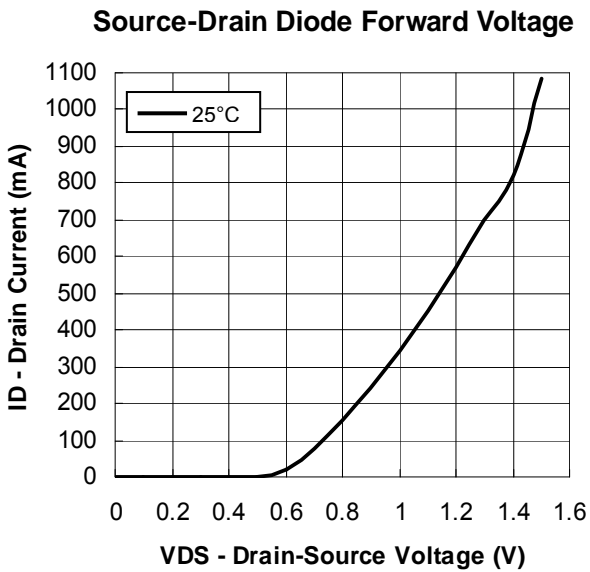
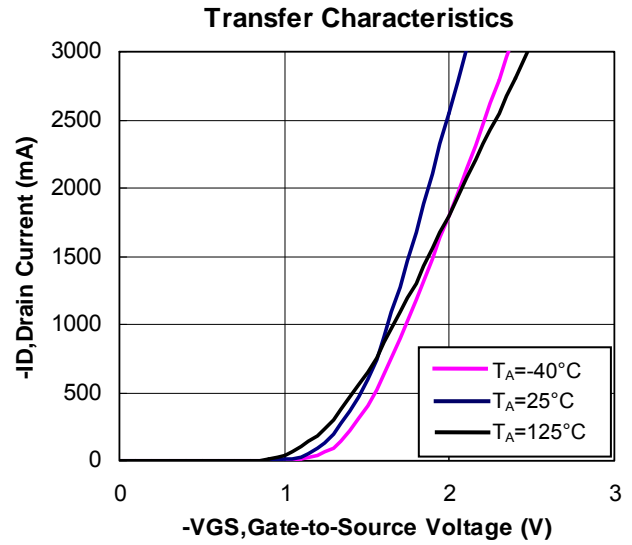
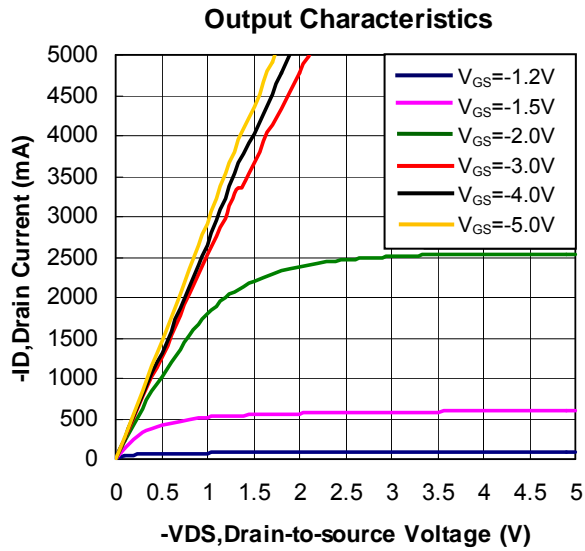

Typical Characteristics ($T_J=25^\circ\text{C}$, unless otherwise noted)

On-Resistance vs. Gate-to-Source Voltage

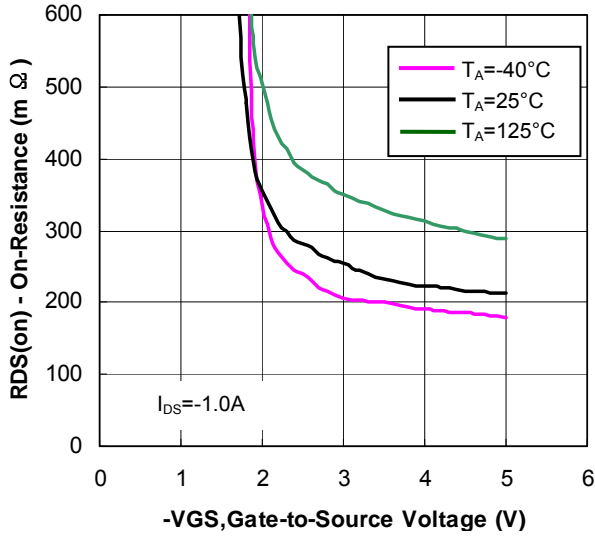

On-Resistance vs. Ambient Temperature

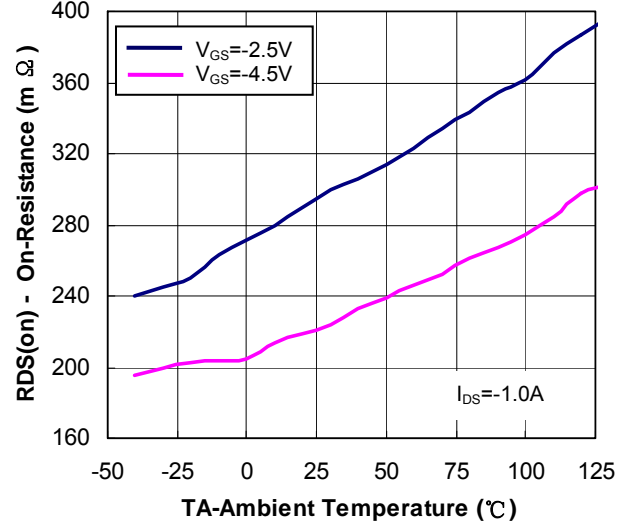

Threshold Voltage vs. Ambient Temperature

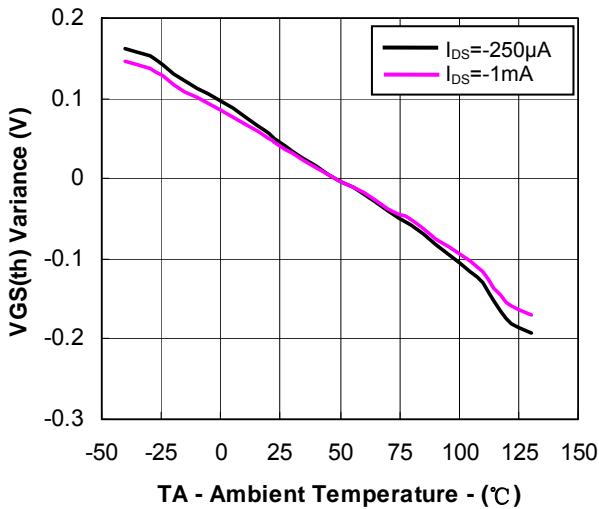

Package Information

UM2301S SOT23-3

Outline Drawing

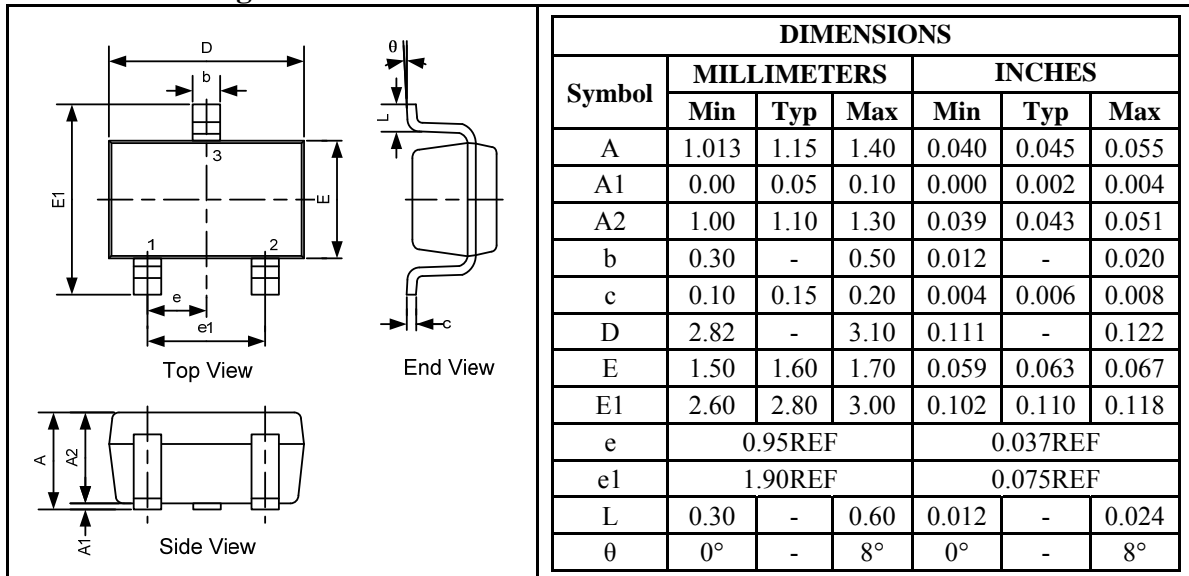

Land Pattern

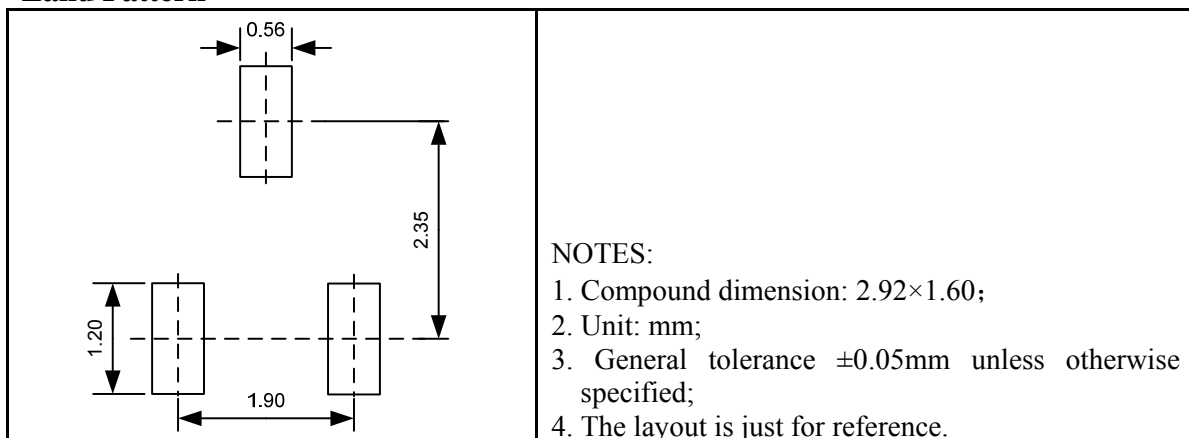

Tape and Reel Orientation



UM2301P SOT323

Outline Drawing

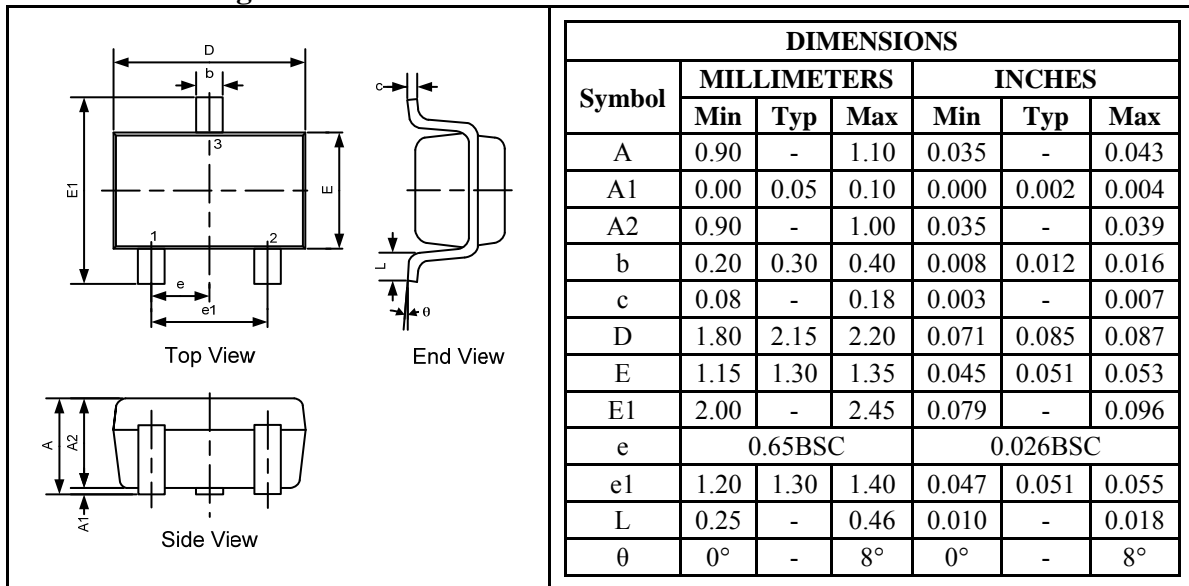

Land Pattern

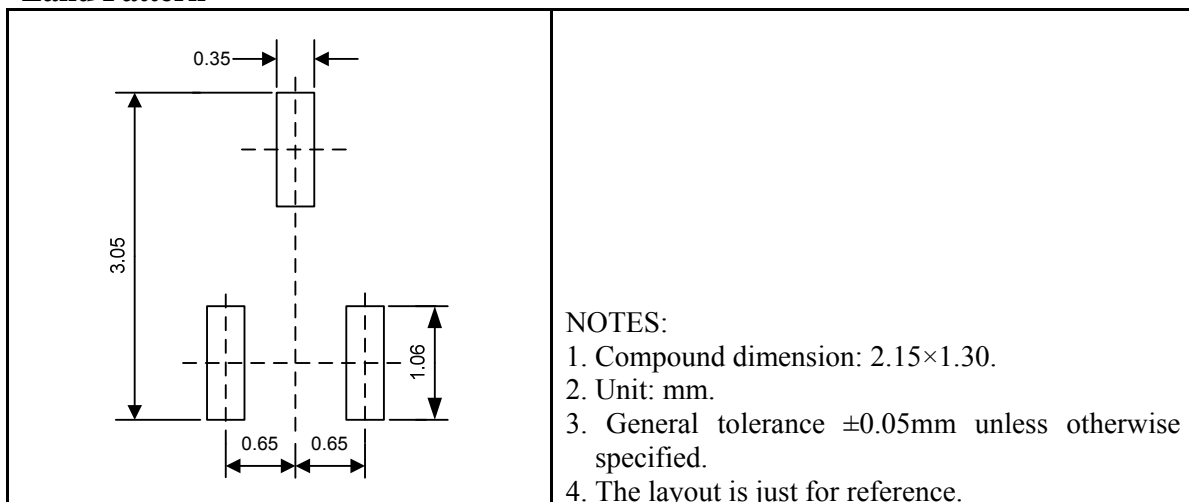

Tape and Reel Orientation



GREEN COMPLIANCE

Union Semiconductor is committed to environmental excellence in all aspects of its operations including meeting or exceeding regulatory requirements with respect to the use of hazardous substances. Numerous successful programs have been implemented to reduce the use of hazardous substances and/or emissions.

All Union components are compliant with the RoHS directive, which helps to support customers in their compliance with environmental directives. For more green compliance information, please visit:

http://www.union-ic.com/index.aspx?cat_code=RoHSDeclaration

IMPORTANT NOTICE

The information in this document has been carefully reviewed and is believed to be accurate. Nonetheless, this document is subject to change without notice. Union assumes no responsibility for any inaccuracies that may be contained in this document, and makes no commitment to update or to keep current the contained information, or to notify a person or organization of any update. Union reserves the right to make changes, at any time, in order to improve reliability, function or design and to attempt to supply the best product possible.



Union Semiconductor, Inc

Add: Unit 606, No.570 Shengxia Road, Shanghai 201210

Tel: 021-51093966

Fax: 021-51026018

Website: www.union-ic.com