

DESCRIPTION

The MP6500A is a stepper motor driver with a built-in translator and current regulation. Current sensing is internal and requires no external sense resistors. High integration and a small package size make the MP6500A a space-saving and cost-effective solution for bipolar stepper motor drives.

The MP6500A operates from a supply voltage of up to 35V, and can deliver motor currents up to 2.5A (depending on PCB design and thermal conditions). The MP6500A can operate a bipolar stepper motor in full-, half-, quarter-, or eighth-step modes. Internal safety features include over-current protection (OCP), input over-voltage protection (OVP), under-voltage lockout (UVLO), and thermal shutdown.

The MP6500A is identical to the MP6500, except the current setting is accomplished with a voltage input instead of a resistor to ground.

The MP6500A is available in QFN-24 (5mmx5mm) and TSSOP-28EP packages.

FEATURES

- Wide 4.5V to 35V Input Voltage Range
- Two Internal Full-Bridge Drivers
- Internal Current Sensing and Regulation
- Low On Resistance (HS: 195mΩ, LS: 170mΩ)
- No Control Power Supply Required
- Simple Logic Interface
- 3.3V and 5V Compatible Logic Supply
- Step Modes from Full-Step to Eighth-Step
- 2.5A Output Current
- Automatic Current Decay
- Over-Current Protection (OCP)
- Input Over-Voltage Protection (OVP)
- Thermal Shutdown and Under-Voltage Lockout (UVLO) Protection
- Fault Indication Output
- Available in QFN-24 (5mmx5mm) and Thermally Enhanced TSSOP-28EP Packages

APPLICATIONS

- Bipolar Stepper Motors
- Printers

All MPS parts are lead-free, halogen-free, and adhere to the RoHS directive. For MPS green status, visit the MPS website under Quality Assurance. "MPS", the MPS logo, and "Simple, Easy Solutions" are registered trademarks of Monolithic Power Systems, Inc. or its subsidiaries.

TYPICAL APPLICATION

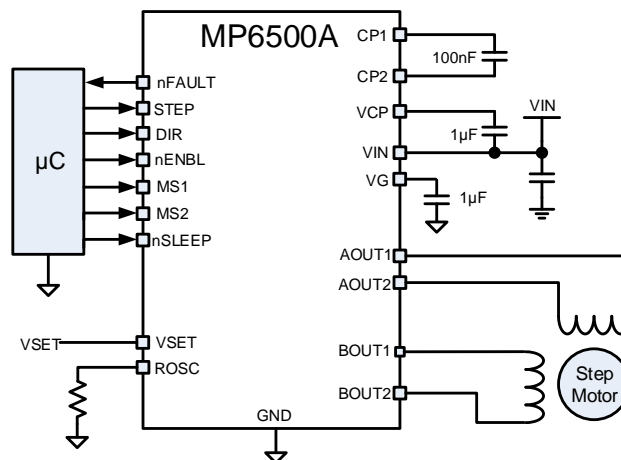

ORDERING INFORMATION

Part Number	Package	Top Marking	MSL Rating
MP6500AGF*	TSSOP-28EP	<i>See Below</i>	2A
MP6500AGU**	QFN-24 (5mmx5mm)	<i>See Below</i>	2

* For Tape & Reel, add suffix -Z (e.g. MP6500AGF-Z).

** For Tape & Reel, add suffix -Z (e.g. MP6500AGU-Z).

TOP MARKING

MPSYYW

MP6500A

LLLLLLLLL

MPS: MPS prefix
 YY: Year code
 WW: Week code
 MP6500A: Part number
 LLLLLLLLL: Lot number

PACKAGE REFERENCE

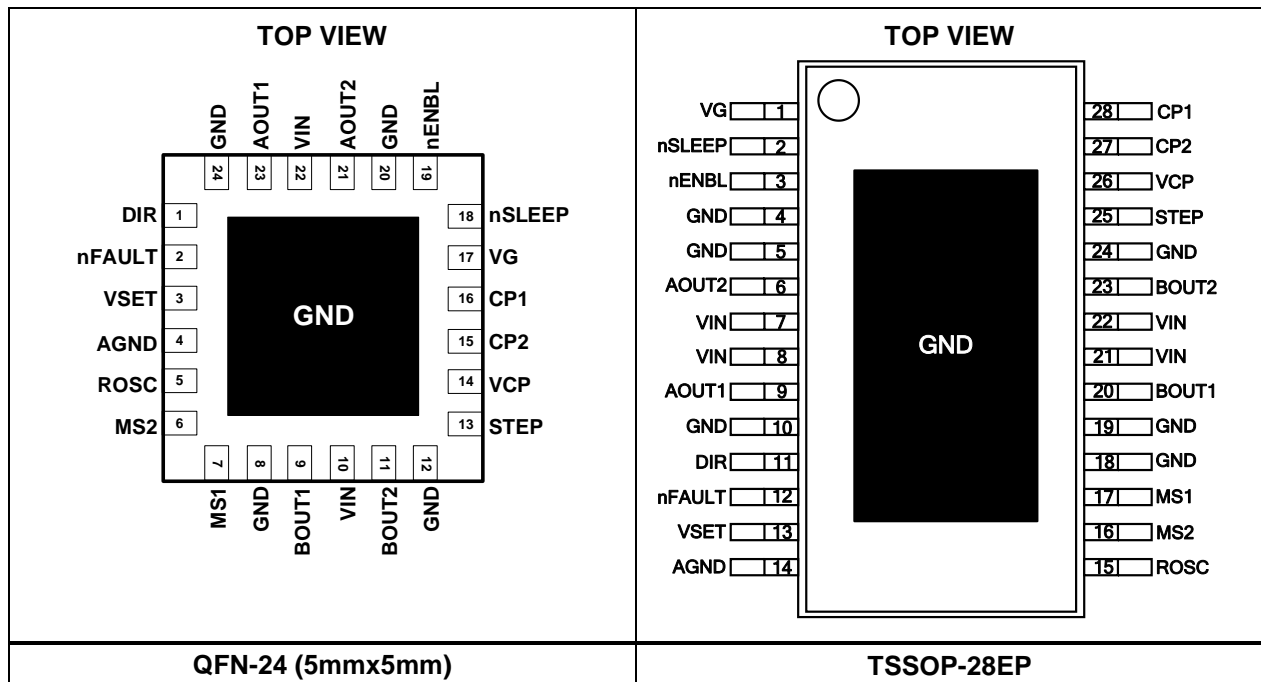

PIN FUNCTIONS

Pin #		Name	Description
TSSOP-28EP	QFN-24 (5mmx5mm)		
1	17	VG	Low-side MOSFET gate drive voltage. VG requires a 220nF to 1µF, 16V, ceramic capacitor to ground.
2	18	nSLEEP	Sleep mode input. Drive nSLEEP to logic high to enable normal operation. nSLEEP has an internal pull-down resistor .
3	19	nENBL	Enable input. Drive nENBL to logic high to disable the bridge outputs and translator operation. Drive nENBL to logic low to enable the bridge outputs and translator operation. nENBL has an internal pull-down resistor.
4, 5, 10, 18, 19, 24, EP	8, 12, 20, 24, EP	GND	Power ground.
6	21	AOUT2	Bridge A output terminal 2.
7, 8, 21, 22	10, 22	VIN	Input supply voltage. All VIN pins must be connected to the same supply. Decouple VIN to ground with a minimum 100nF ceramic capacitor.
9	23	AOUT1	Bridge A output terminal 1.
11	1	DIR	Direction input. DIR has an internal pull-down resistor.
12	2	nFAULT	Fault indication. nFAULT is an open-drain output. Drive nFAULT to logic low when in a fault condition (OCP, OTP, OVP).
13	3	VSET	Current set programming. A voltage between 0V and 2V applied to VSET sets the current through the motor.
14	4	AGND	Analog ground.
15	5	ROSC	Constant off-time programming. A resistor from ROSC to ground sets the PWM off time.
16	6	MS2	Mode selection. MS1 and MS2 set the step mode (full-, half-, quarter-, or eighth-step). MS1 and MS2 each have an internal pull-down resistor.
17	7	MS1	
20	9	BOUT1	Bridge B output terminal 1.
23	11	BOUT2	Bridge B output terminal 2.
25	13	STEP	Step input. The rising edge sequences the translator and advances the motor by one increment. STEP has an internal pull-down resistor.
26	14	VCP	Charge pump output. VCP requires a 1µF, 16V, ceramic capacitor to VIN.
27	15	CP2	Charge pump capacitor. Connect a 100nF ceramic capacitor rated for the VIN voltage between these terminals.
28	16	CP1	

ABSOLUTE MAXIMUM RATINGS ⁽¹⁾

Supply voltage (V_{IN})	-0.3V to +40V
xOUTx voltage ($V_{A/BOU1/2}$).....	-0.7V to +40V
xOUTx voltage ($V_{A/BOU1/2}$) (transient, 2 μ s)	
.....	-1.5V to $V_{IN} + 1.5V$
CP1	-0.3V to V_{IN}
CP1 (transient, 2 μ s).....	-1.5V to $V_{IN} + 1.5V$
VCP	$V_{IN} - 1V$ to $V_{IN} + 6.5V$
CP2	$V_{IN} - 0.5V$ to $V_{CP} + 0.5V$
CP2 (transient, 10 μ s).....	$V_{IN} - 2V$ to $V_{CP} + 2V$
All other pins to AGND.....	-0.3V to +6.5V
ESD rating (HBD)	2kV
Continuous power dissipation ($T_A = 25^\circ C$) ⁽²⁾	
TSSOP-28EP	3.9W
QFN-24 (5mmx5mm).....	3.5W
Storage temperature.....	-55 $^\circ C$ to +150 $^\circ C$
Junction temperature	+150 $^\circ C$
Lead temperature (solder)	+260 $^\circ C$

Recommended Operating Conditions ⁽³⁾

Supply voltage (V_{IN})	4.5V to 35V
Output current ($I_{A/BOU}$)	$\pm 2.5A$
Operating junction temp (T_J)... ..	-40 $^\circ C$ to +125 $^\circ C$

Thermal Resistance ⁽⁴⁾	θ_{JA}	θ_{JC}
TSSOP-28EP	32.....	6 $^\circ C/W$
QFN-24 (5mmx5mm)	36.....	8 $^\circ C/W$

Notes:

- 1) Exceeding these ratings may damage the device.
- 2) The maximum allowable power dissipation is a function of the maximum junction temperature T_J (MAX), the junction-to-ambient thermal resistance θ_{JA} , and the ambient temperature T_A . The maximum allowable continuous power dissipation at any ambient temperature is calculated by P_D (MAX) = (T_J (MAX) - T_A) / θ_{JA} . Exceeding the maximum allowable power dissipation produces an excessive die temperature, causing the regulator to go into thermal shutdown. Internal thermal shutdown circuitry protects the device from permanent damage.
- 3) The device is not guaranteed to function outside of its operating conditions.
- 4) Measured on JESD51-7, 4-layer PCB.

ELECTRICAL CHARACTERISTICS

$V_{IN} = 24V$, $T_A = 25^{\circ}C$, unless otherwise noted.

Parameter	Symbol	Condition	Min	Typ	Max	Units
Power Supply						
Input supply voltage	V_{IN}		4.5	24	35	V
Quiescent current	I_Q	$V_{IN} = 24V$, $nENBL = 0$, $nSLEEP = 1$, with no load		1.9	5	mA
	I_{SLEEP}	$V_{IN} = 24V$, $nSLEEP = 0$			1	μA
Internal MOSFETs						
Output on resistance	R_{HS}	$V_{IN} = 24V$, $I_{OUT} = 1A$, $T_J = 25^{\circ}C$		0.195	0.23	Ω
		$V_{IN} = 24V$, $I_{OUT} = 1A$, $T_J = 85^{\circ}C$		0.25		Ω
	R_{LS}	$V_{IN} = 24V$, $I_{OUT} = 1A$, $T_J = 25^{\circ}C$		0.17	0.22	Ω
		$V_{IN} = 24V$, $I_{OUT} = 1A$, $T_J = 85^{\circ}C$		0.25		Ω
Body diode forward voltage	V_F	$I_{OUT} = 1.5A$			1.1	V
Control Logic						
Input logic low threshold	V_{IL}				0.8	V
Input logic high threshold	V_{IH}		2.1			V
Logic input current	$I_{IN(H)}$	$V_{IH} = 5V$			20	μA
	$I_{IN(L)}$	$V_{IL} = 0.8V$			5	μA
Internal pull-down resistance	R_{PD}			500		k Ω
nFAULT Outputs (Open-Drain Outputs)						
Output low voltage	V_{OL}	$I_O = 5mA$			0.5	V
Output high leakage current	I_{OH}	$V_O = 3.3V$			1	μA
Protection Circuit						
UVLO rising threshold	V_{IN_RISE}			3.4	4.5	V
Input OVP threshold	V_{OVP}		36	37.5	38.5	V
Input OVP hysteresis	ΔV_{OVP}			1900		mV
Over-current trip level	I_{OCP1}	Sinking	3.5	6	8.5	A
	I_{OCP2}	Sourcing	3.5	6	8.5	A
Over-current deglitch time	t_{OCP}			1		μs
Thermal shutdown ⁽⁵⁾	T_{TSD}			165		$^{\circ}C$
Thermal shutdown hysteresis ⁽⁵⁾	ΔT_{TSD}			15		$^{\circ}C$
Current Regulation						
Constant off time	t_{OFF}	$R_{OSC} = 200k\Omega$	20	23	26	μs
Peak current regulation level	I_{PEAK}	$V_{VSET} = 0.75V$	0.95	1	1.05	A
VSET voltage range	V_{VSET}		0		2	V
VSET voltage ratio	A_{VSET}	V_{VSET} / I_{OUT}		0.75		V/A
Blanking time ⁽⁵⁾	t_{BLANK}			2		μs
Current trip accuracy	ΔI_{TRIP}	$V_{VSET} = 0.75V$, 71% - 100%	-5		+5	%
		$V_{VSET} = 0.75V$, 38% - 67%	-9		+9	%
		$V_{VSET} = 0.75V$, <34%	-12		+12	%

TIMING CHARACTERISTICS

VIN = 24V, TA = 25°C, unless otherwise noted.

Parameter	Symbol	Condition	Min	Typ	Max	Units
STEP high time ⁽⁵⁾	t1		1			μs
STEP low time ⁽⁵⁾	t2		1			μs
Set-up time MSx, DIR to STEP rising ⁽⁵⁾	t3		200			ns
Hold time STEP rising to MSx, DIR change ⁽⁵⁾	t4		200			ns

Note:

5) Guaranteed by design.

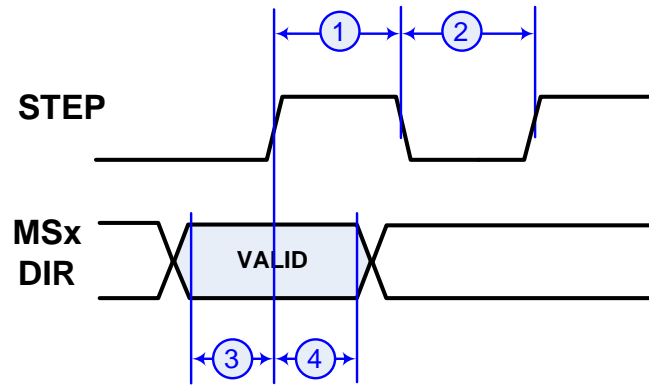
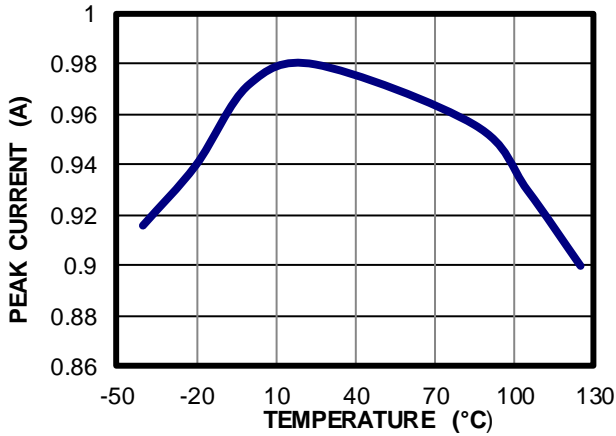

Figure 1: STEP Timing Diagram

TYPICAL CHARACTERISTICS

Peak Current Regulation Level vs. Temperature

$V_{SET} = 0.7V$



Bridge A HS On Resistance vs. Temperature

$V_{IN} = 24V, I_{OUT} = 1A$

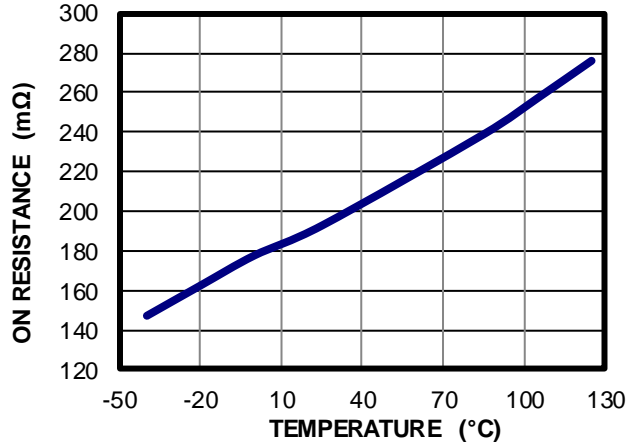

Bridge B HS On Resistance vs. Temperature

$V_{IN} = 24V, I_{OUT} = 1A$

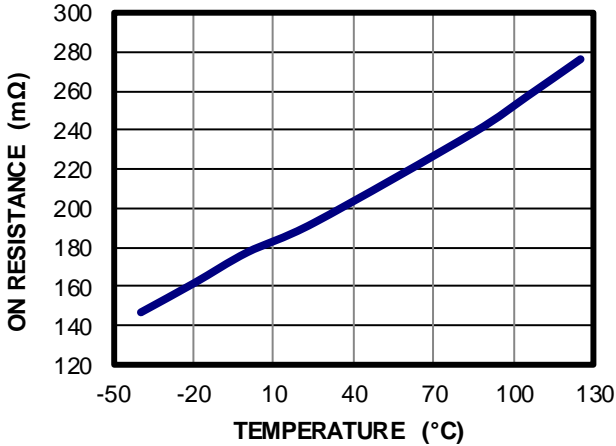

Bridge A LS On Resistance vs. Temperature

$V_{IN} = 24V, I_{OUT} = 1A$

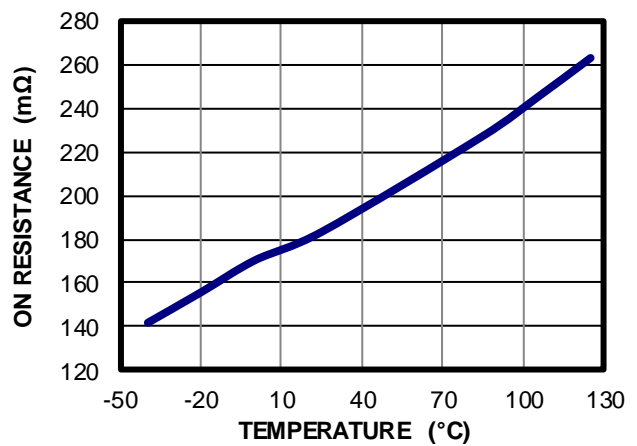

Bridge B LS On Resistance vs. Temperature

$V_{IN} = 24V, I_{OUT} = 1A$

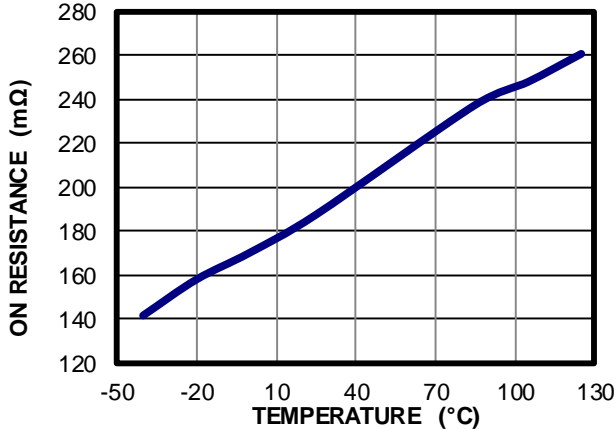

Input OVP Threshold vs. Temperature

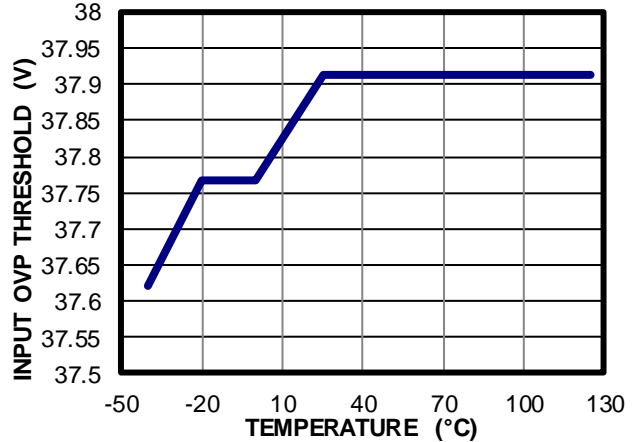

TYPICAL PERFORMANCE CHARACTERISTICS

$V_{IN} = 24V$, $I_{OUT} = 2.5A$, $f_{STEP} = 1kHz$, $T_A = 25^{\circ}C$, resistor + inductor load: $R = 3.3\Omega$, $L = 1.5mH$ / channel, unless otherwise noted.

Steady State, Full-Step

$I_{OUT} = 2A$

CH1: STEP
2V/div.
CH2: A_{OUT1}
20V/div.
CH3: A_{OUT2}
20V/div.
CH4: I_{OUTA}
2A/div.

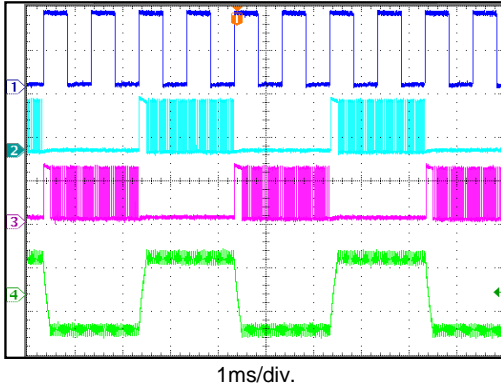

Steady State, Half-Step

CH1: STEP
5V/div.
CH2: A_{OUT1}
20V/div.
CH3: A_{OUT2}
20V/div.
CH4: I_{OUTA}
2A/div.

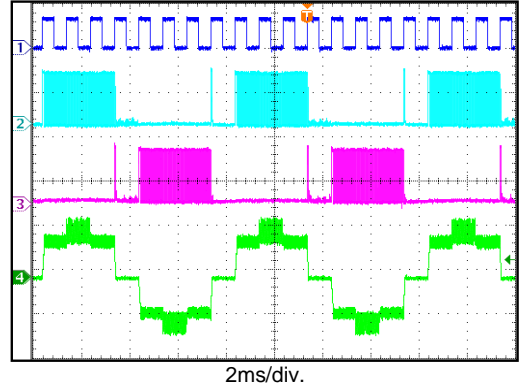

Steady State, Quarter-Step

CH1: STEP
5V/div.
CH2: A_{OUT1}
20V/div.
CH3: A_{OUT2}
20V/div.
CH4: I_{OUTA}
2A/div.

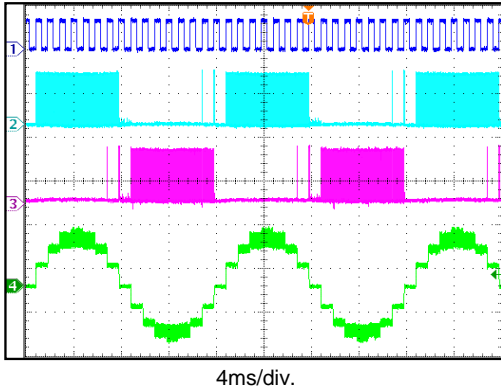

Steady State, Eighth-Step

CH1: STEP
5V/div.
CH2: A_{OUT1}
20V/div.
CH3: A_{OUT2}
20V/div.
CH4: I_{OUTA}
2A/div.

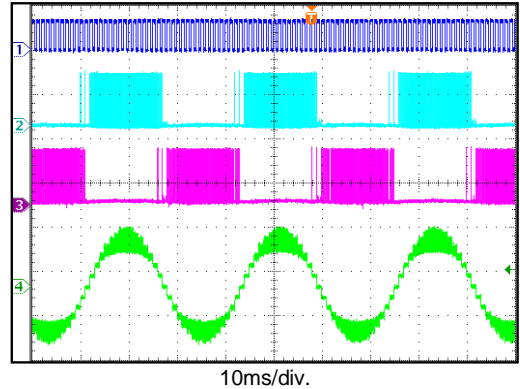

Power Ramp-Up, Full-Step

$I_{OUT} = 2A$

CH1: V_{IN}
20V/div.
CH2: A_{OUT1}
20V/div.
CH3: A_{OUT2}
20V/div.
CH4: I_{OUTA}
2A/div.

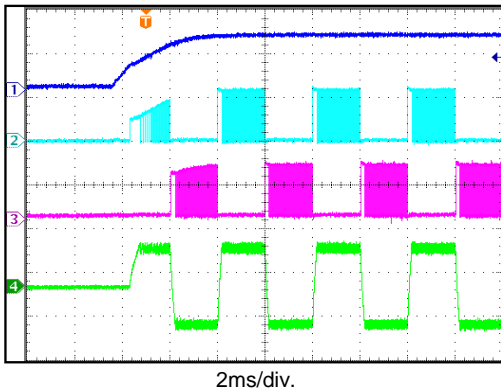

Power Ramp-Up, Half-Step

CH1: V_{IN}
20V/div.
CH2: A_{OUT1}
20V/div.
CH3: A_{OUT2}
20V/div.
CH4: I_{OUTA}
2A/div.

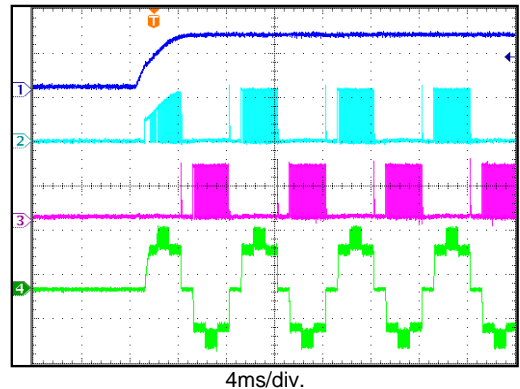

TYPICAL PERFORMANCE CHARACTERISTICS *(continued)*

$V_{IN} = 24V$, $I_{OUT} = 2.5A$, $f_{STEP} = 1kHz$, $T_A = 25^{\circ}C$, resistor + inductor load: $R = 3.3\Omega$, $L = 1.5mH$ / channel, unless otherwise noted.

Power Ramp-Up, Quarter-Step

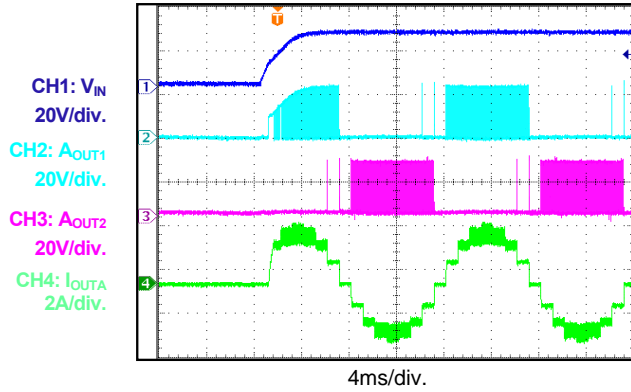

Power Ramp-Up, Eighth-Step

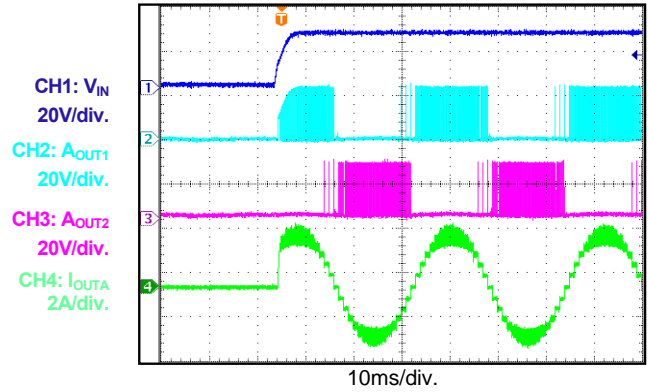

Enable, Full-Step

$I_{OUT} = 2A$

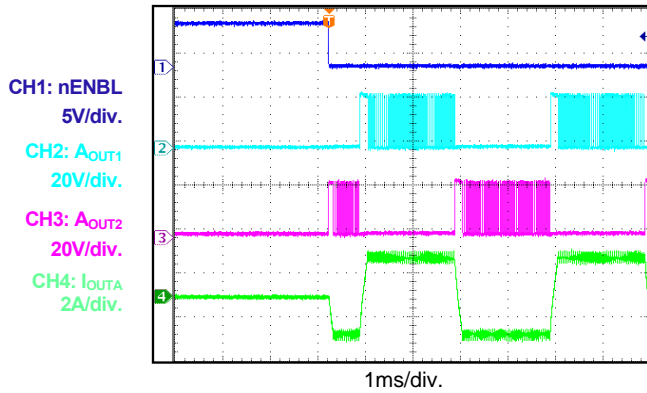

Enable, Half-Step

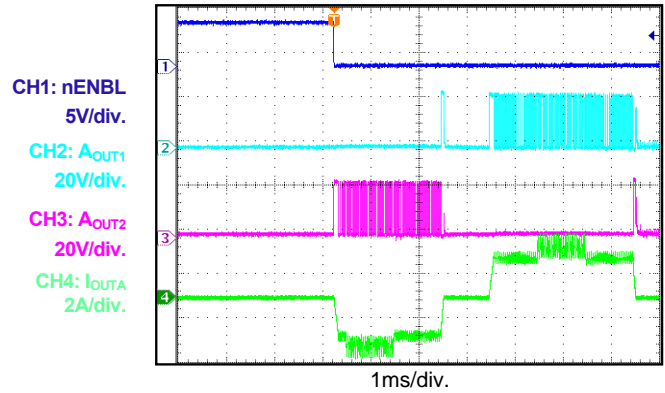

Enable, Quarter-Step

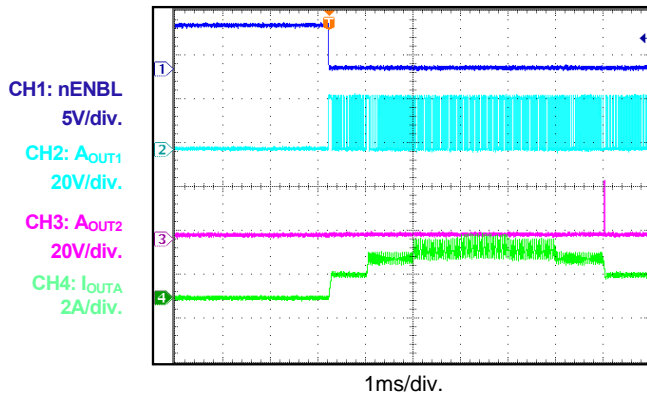

Enable, Eighth-Step

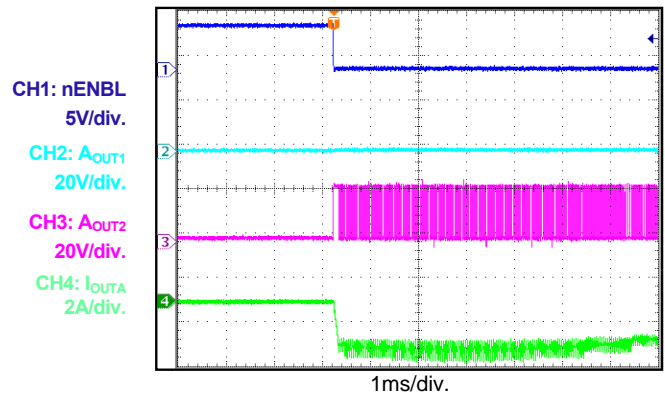

FUNCTIONAL BLOCK DIAGRAM

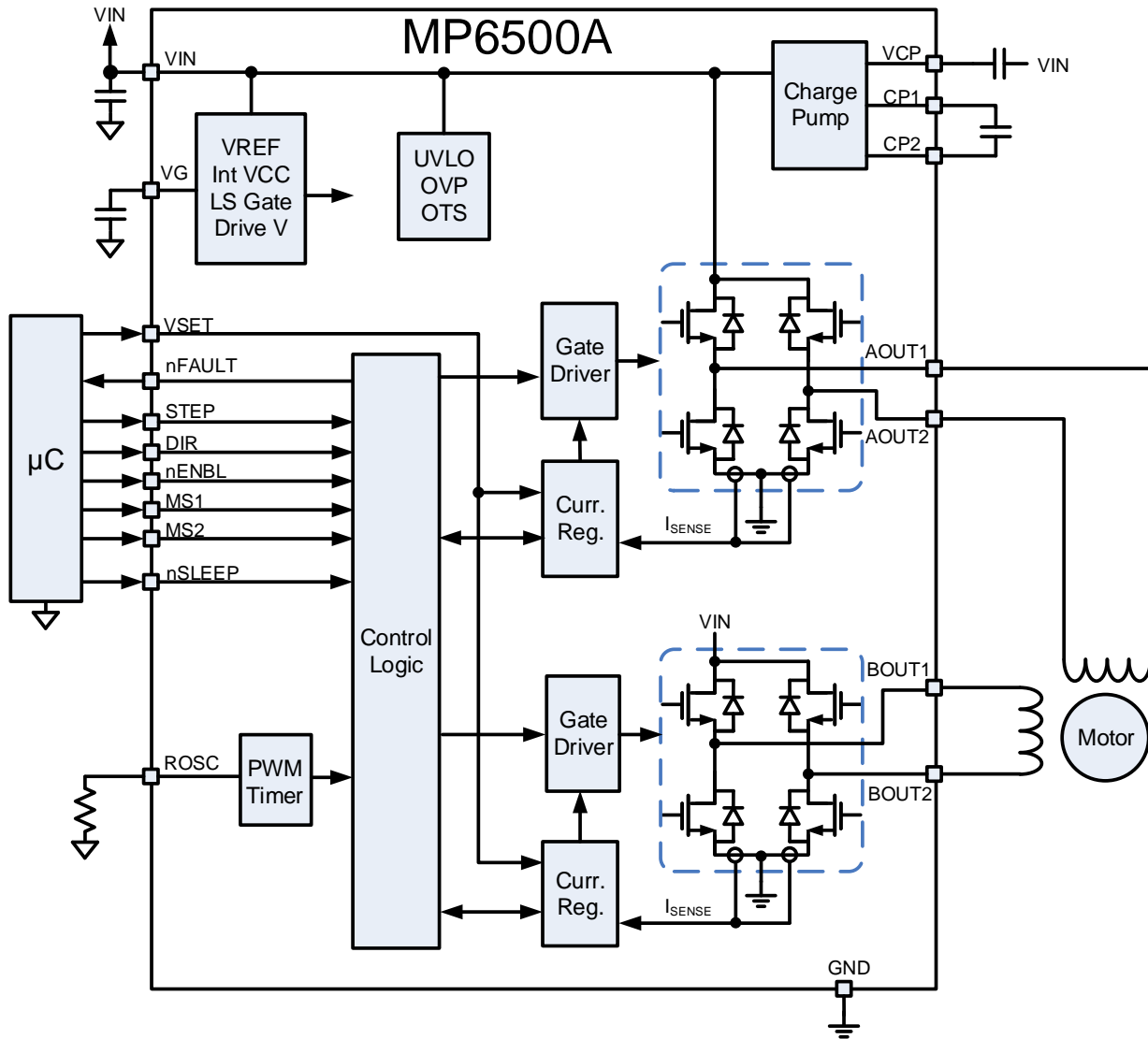

Figure 2: Functional Block Diagram

OPERATION

The MP6500A is a bipolar stepper motor driver that integrates eight N-channel power MOSFETs arranged as two full-bridges with 2.5A of current capability each. The MP6500A operates over a wide 4.5V to 35V supply voltage range.

The MP6500A is designed to operate bipolar stepper motors in full-, half-, quarter-, and eighth-step modes. At each step, the current of each full-bridge is set by the output voltage of a DAC, which is controlled by the output of the translator.

The currents in each of the two outputs are regulated with programmable, constant-off-time, pulse-width modulation (PWM) control circuitry. The MP6500A integrates internal current sensing with no external sense resistors required.

Stepping

The motor moves step by step by applying a series of pulses to STEP. A rising edge on the STEP input sequences the translator and advances the motor by one increment. The translator controls the input to the DACs and the direction of current flow in each winding. The amplitude of the increment (step size) is determined by the state of the inputs (MS1 and MS2) (see Table 1).

The state of DIR determines the direction of the rotation of the stepper motor.

The minimum STEP pulse width is 1μs. The logic control inputs MSx and DIR require at least 200ns of set-up time and hold time to the rising edge of the STEP input (see Figure 3).

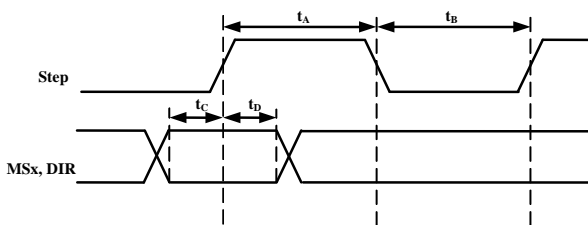

Figure 3: STEP Timing Diagram

Programmable Constant Off-Time Current Control

The motor current is regulated by a programmable, constant-off-time PWM current control circuit.

Initially, a diagonal pair of MOSFETs turns on and drives current through the motor winding. The current increases in the motor winding, which is sensed by an internal current-sense circuit. During the initial blanking time (t_{BLANK}), the high-side MOSFET (HS-FET) always turns on in spite of current limit detection.

When the current reaches the current trip threshold, the internal current comparator either uses slow decay or fast decay. In slow decay, the comparator shuts off the HS-FET so the winding inductance current freewheels through the two low-side MOSFETs (LS-FET). In fast decay, it turns on another diagonal pair of MOSFETs so the current flows back to the input. The current continues decreasing for the constant-off-time duration unless a zero current level is detected. Afterward, the HS-FET is enabled to increase the winding current again. The cycle then repeats.

The constant-off-time (t_{OFF}) is determined by the selection of an external resistor (R_{OSC}), which can be approximated with Equation (1):

$$t_{OFF}(\text{ns}) = 115 \times R_{OSC}(\text{k}\Omega) \quad (1)$$

The full-scale (100%) regulation current can be calculated with Equation (2):

$$I_{Max} = V_{VSET} / 0.75 \quad (2)$$

The DAC output reduces the trip current in precise steps. Calculate the trip current with Equation (3):

$$I_{Trip} = \%I_{Trip} \times I_{Max} \quad (3)$$

See Table 2 for $\%I_{Trip}$ at each step.

Blanking Time

There is usually a current spike during the switching transition due to the body diode's reverse-recovery current and the distributed winding capacitance of the motor. This current spike requires filtering to prevent it from erroneously shutting down the HS-FET.

After the PWM cycle begins, the output of the current-sense comparator is ignored for the fixed blanking time. This blanking time results in a minimum on time for the PWM cycle.

Automatic Decay Mode

The MP6500A uses a fully automatic decay mode to provide accurate current regulation.

Initially, slow decay is used. At the end of the fixed off time, if the current is above the I_{TRIP} threshold, then fast decay mode is initiated by reversing the state of the H-bridge outputs.

Once the current level during this fast decay period drops below the I_{TRIP} threshold, slow decay is again engaged for another fixed off time. After the completion of this second fixed off time, a new PWM cycle begins.

Figure 4 shows the automatic decay mode operation during a current reduction as a result of a step input.

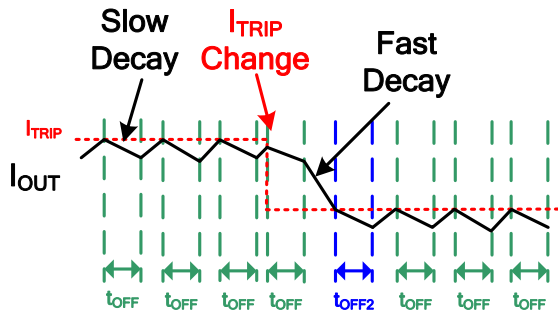

Figure 4: Slow Decay During t_{OFF} unless $I_{OUT} > I_{TRIP}$ at end of t_{OFF}

In some cases—specifically high voltage and low inductance or the regulation of very small currents—the minimum on time of the PWM cycle (set by the blanking time described above) can cause the current to rise very quickly. In this case, both slow and fast decay are used (see Figure 5).

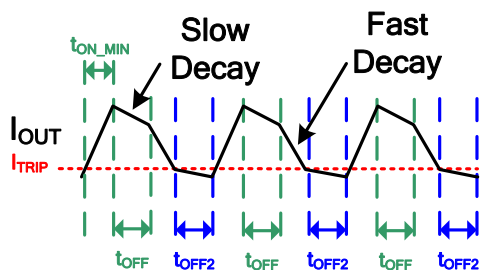

Figure 5: Current Regulation of Low Current/Low Inductance

Microstep Selection (MS1, MS2)

The step mode is selected by applying logic high and low voltages to MS1 and MS2 (see Table 1). The MP6500A supports full-, half-, quarter-, and eighth-step modes for progressively finer step resolution and control.

Table 1: Stepping Format

MS2	MS1	STEP Mode
L	L	Full-step
L	H	Half-step
H	L	Quarter-step
H	H	Eighth-step

Full-step mode has four states, with each motor winding driven with either 70.7% of the maximum positive current or 70.7% of the maximum negative current. This provides four steps per electrical rotation. Half-step mode creates eight steps per electrical rotation. Quarter- and eighth-step modes provide 16 and 32 steps per rotation, respectively.

Table 2 on page 14, Table 3 on page 15, and Figures 6–9 on pages 16–17 show the relative current level sequence for different MSx settings.

The MSx pins have internal pull-down resistors.

nSLEEP, nENBL Operation

Driving nSLEEP low puts the device into a low-power sleep state. In this state, the gate drive charge pump is stopped, and all the internal circuits and H-bridge outputs are disabled. All inputs are ignored when nSLEEP is active low.

When waking up from sleep mode, approximately 1ms of time must pass before a STEP command can be issued, to allow the internal circuitry to stabilize. nSLEEP has an internal pull-down resistor.

The nENBL pin is used to control the output drivers. When nENBL is low, the H-bridge outputs are enabled, and the rising edges on STEP are recognized. When nENBL is high, the H-bridge outputs are disabled, and the STEP input is ignored. nENBL has an internal pull-down resistor.

Fault Reporting

The MP6500A provides an nFAULT pin, which reports if a fault condition (such as OCP, OTP, or OVP) occurs. nFAULT is an open-drain

output, and is driven low when a fault condition occurs. If the fault condition is removed, nFAULT is pulled high by an external pull-up resistor.

Over-Current Protection (OCP)

Over-current protection (OCP) circuitry limits the current through the MOSFETs by disabling the gate driver. If the over-current limit threshold is exceeded for longer than the over-current deglitch time, all MOSFETs in the H-bridge are disabled, and nFAULT is driven low. The driver typically remains disabled for 2.4ms, at which time it is re-enabled automatically.

Over-current conditions on both high- and low-side devices (e.g. a short to ground, supply, or across the motor winding) result in an over-current shutdown. Note that OCP does not use the current-sense circuitry used for PWM current control.

Over-Voltage Protection (OVP)

If the input voltage on VIN is higher than the over-voltage protection (OVP) threshold, the H-bridge output is disabled, and nFAULT is driven low. This protection is released when VIN drops below 36V.

Input Under-Voltage Lockout (UVLO) Protection

If at any time the voltage on VIN falls below the under-voltage lockout (UVLO) threshold, all circuitry in the device is disabled, and the internal logic is reset. Operation resumes when VIN rises above the UVLO threshold.

Thermal Shutdown

If the die temperature exceeds safe limits, all MOSFETs in the H-bridge are disabled, and nFAULT is driven low. Once the die temperature has fallen to a safe level, operation resumes automatically.

MICROSTEPPING
Table 2: Relative Current Level Sequence (DIR = 1)

Eighth-Step #	Quarter-Step #	Half-Step #	Full-Step #	Phase A Current (%I_{Trip}) (%)	Phase B Current (%I_{Trip}) (%)	Step Angle (deg)
1	1	1		100	0	0
2				98.08	19.51	11.3
3	2			92.39	38.27	22.5
4				83.15	55.56	33.8
5	3	2	1	70.71	70.71	45
6				55.56	83.15	56.3
7	4			38.27	92.39	67.5
8				19.51	98.08	78.8
9	5	3		0	100	90
10				-19.51	+98.08	101.3
11	6			-38.27	+92.39	112.5
12				-55.56	+83.15	123.8
13	7	4	2	-70.71	+70.71	135
14				-83.15	+55.56	146.3
15	8			-92.39	+38.27	157.5
16				-98.08	+19.51	168.8
17	9	5		-100	0	180
18				-98.08	-19.51	191.3
19	10			-92.39	-38.27	202.5
20				-83.15	-55.56	213.8
21	11	6	3	-70.71	-70.71	225
22				-55.56	-83.15	236.3
23	12			-38.27	-92.39	247.5
24				-19.51	-98.08	258.8
25	13	7		0	-100	270
26				+19.51	-98.08	281.3
27	14			+38.27	-92.39	292.5
28				+55.56	-83.15	303.8
29	15	8	4	+70.71	-70.71	315
30				+83.15	-55.56	326.3
31	16			+92.39	-38.27	337.5
32				+98.08	-19.51	348.8

MICROSTEPPING (continued)
Table 3: Relative Current Level Sequence (DIR = 0)

Eighth-Step #	Quarter-Step #	Half-Step #	Full-Step #	Phase A Current (%I _{Trip}) (%)	Phase B Current (%I _{Trip}) (%)	Step Angle (deg)
1	1	1		100	0	0
2				+98.08	-19.51	348.8
3	2			+92.39	-38.27	337.5
4				+83.15	-55.56	326.3
5	3	2	1	+70.71	-70.71	315
6				+55.56	-83.15	303.8
7	4			+38.27	-92.39	292.5
8				+19.51	-98.08	281.3
9	5	3		0	-100	27
10				-19.51	-98.08	258.8
11	6			-38.27	-92.39	247.5
12				-55.56	-83.15	236.3
13	7	4	2	-70.71	-70.71	225
14				-83.15	-55.56	213.8
15	8			-92.39	-38.27	202.5
16				-98.08	-19.51	191.3
17	9	5		-100	0	180
18				-98.08	+19.51	168.8
19	10			-92.39	+38.27	157.5
20				-83.15	+55.56	146.3
21	11	6	3	-70.71	+70.71	135
22				-55.56	+83.15	123.8
23	12			-38.27	+92.39	112.5
24				-19.51	+98.08	101.3
25	13	7		0	100	90
26				19.51	98.08	78.8
27	14			38.27	92.39	67.5
28				55.56	83.15	56.3
29	15	8	4	70.71	70.71	45
30				83.15	55.56	33.8
31	16			92.39	38.27	22.5
32				98.08	19.51	11.3

Note:

6) The reset position is at step angle 45°.

MICROSTEPPING (continued)

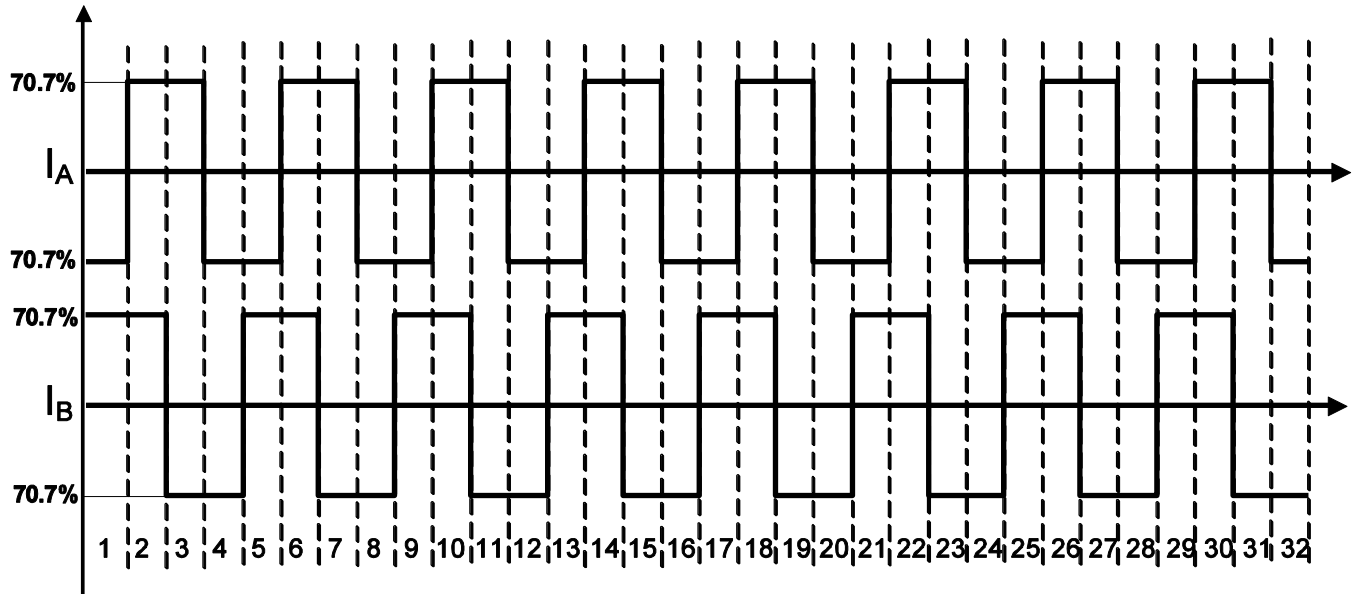

Figure 6: Full-Step (4 Step Sequences, DIR = 0)

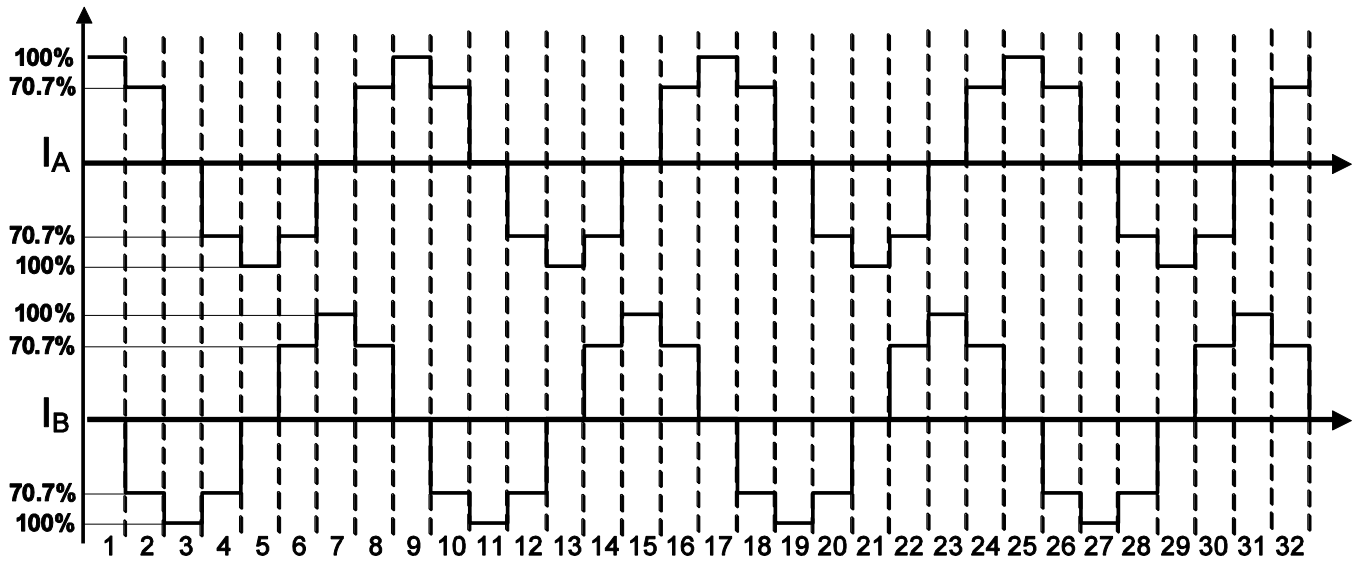

Figure 7: Half-Step (8 Step Sequences, DIR = 0)

MICROSTEPPING *(continued)*

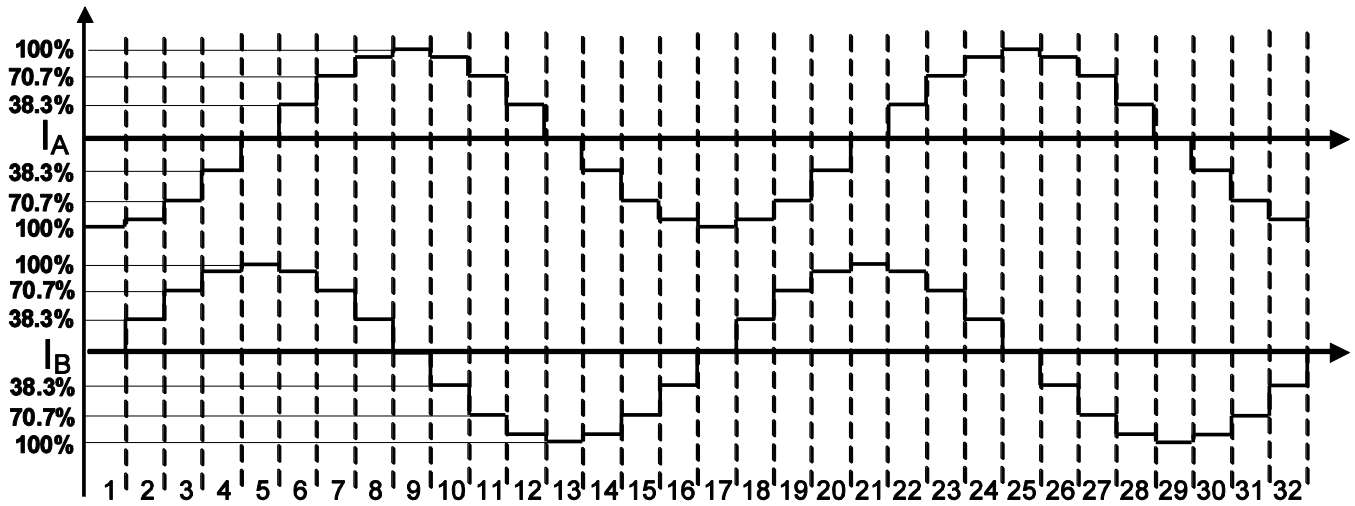

Figure 8: Quarter-Step (16 Step Sequences, DIR = 0)

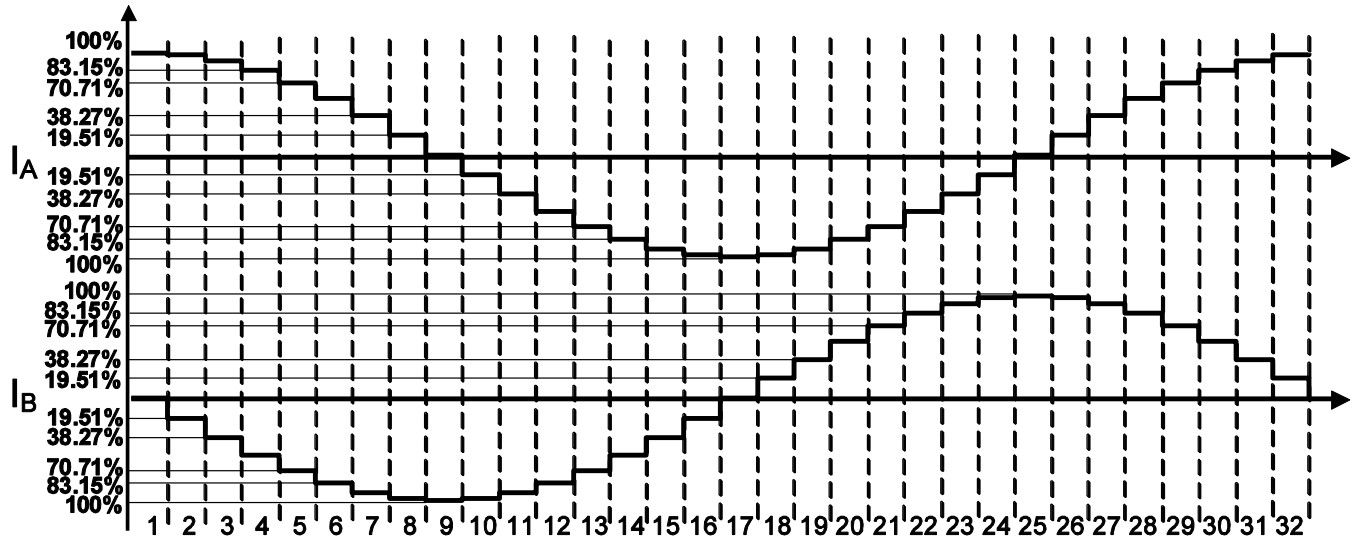
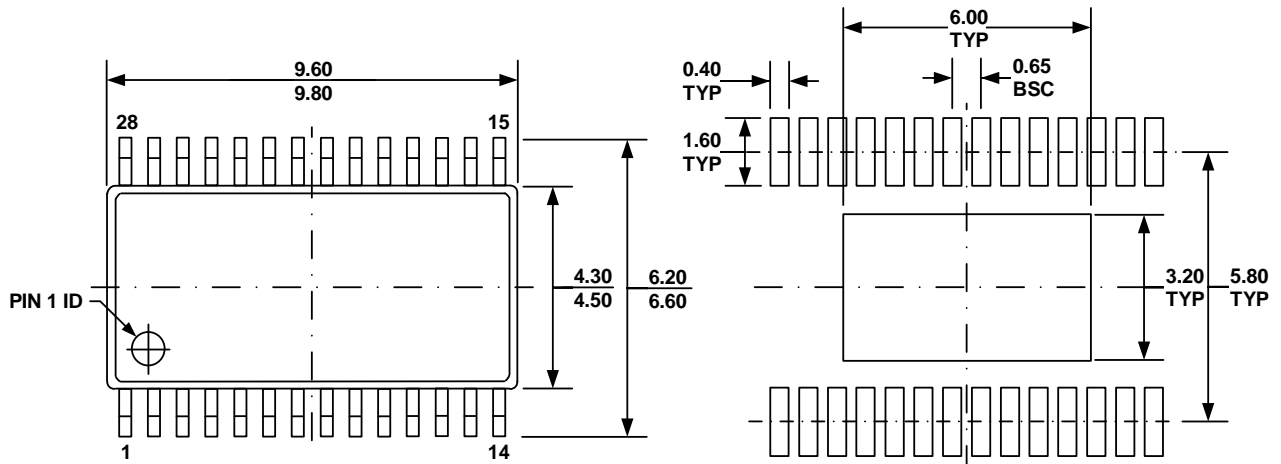

Figure 9: Eighth-Step (32 Step Sequences, DIR = 0)

PACKAGE INFORMATION

TSSOP-28EP



TOP VIEW

RECOMMENDED LAND PATTERN

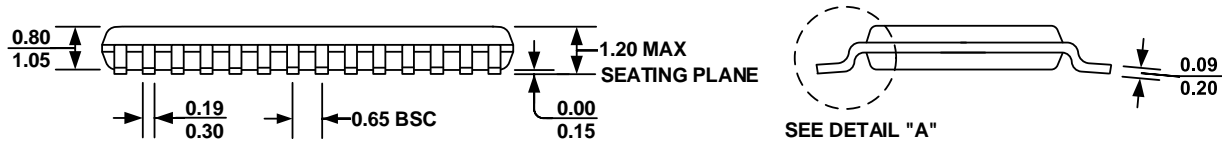

FRONT VIEW

SIDE VIEW

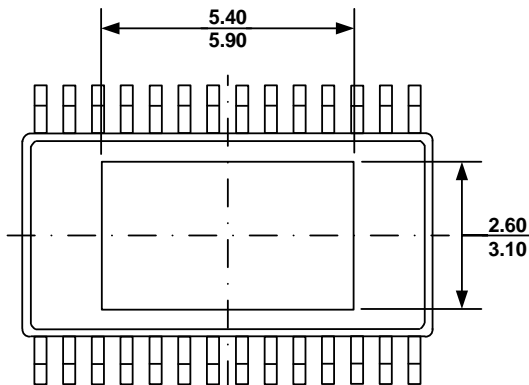

BOTTOM VIEW

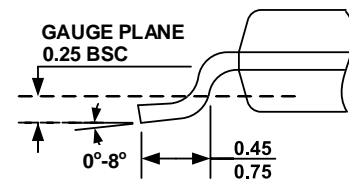

DETAIL "A"

NOTE:

- 1) ALL DIMENSIONS ARE IN MILLIMETERS.
- 2) PACKAGE LENGTH DOES NOT INCLUDE MOLD FLASH, PROTRUSION, OR GATE BURR.
- 3) PACKAGE WIDTH DOES NOT INCLUDE INTERLEAD FLASH OR PROTRUSION.
- 4) LEAD COPLANARITY (BOTTOM OF LEADS AFTER FORMING) SHALL BE 0.10 MILLIMETERS MAX.
- 5) DRAWING CONFORMS TO JEDEC MO-153, VARIATION AET.
- 6) DRAWING IS NOT TO SCALE.

PACKAGE INFORMATION

QFN-24 (5mmx5mm)

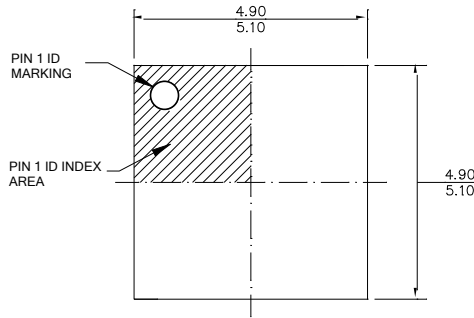

TOP VIEW

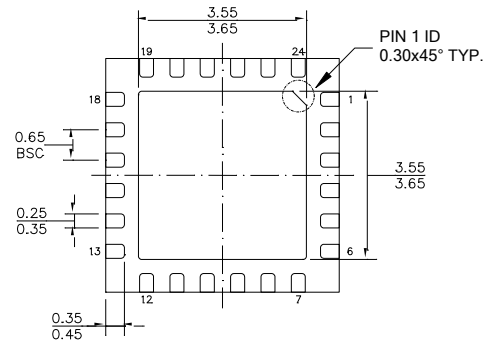

BOTTOM VIEW

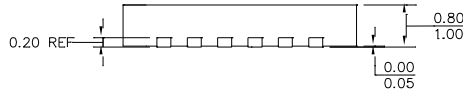

SIDE VIEW

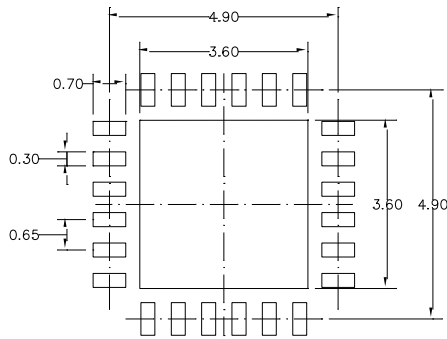

RECOMMENDED LAND PATTERN

NOTE:

- 1) ALL DIMENSIONS ARE IN MILLIMETERS.
- 2) EXPOSED PADDLE SIZE DOES NOT INCLUDE MOLD FLASH.
- 3) LEAD COPLANARITY SHALL BE 0.10 MILLIMETERS MAX.
- 4) DRAWING CONFIRMS TO JEDEC MO-220.
- 5) DRAWING IS NOT TO SCALE.

REVISION HISTORY

Revision #	Revision Date	Description	Pages Updated
1.0	6/10/2019	Initial Release	-
1.1	9/30/2022	Added the new QFN-24 (5mmx5mm) package; updated the TSSOP package terminology to “TSSOP-28EP”	1–2, 4, 18–19
		Updated “-Z” to “-Z” in the Ordering Information section	2
		Updated the xOUTx, CP1, VCP, and CP2 specifications in the Absolute Maximum Ratings section	4
		Updated the output on resistance maximum values in the Electrical Characteristics section; updated the peak current regulation level typical value from “1.0” to “1”; added the plus symbol (+) to the current trip accuracy maximum values; removed duplicate Note 5	5
		Updated Table 2	14
		Added Table 3 to show microstepping at “DIR = 0”; added Note 6	15
		Updated the figure titles to include “DIR = 0”	16–17
		Updated the header and footer formatting	All

Notice: The information in this document is subject to change without notice. Please contact MPS for current specifications. Users should warrant and guarantee that third-party Intellectual Property rights are not infringed upon when integrating MPS products into any application. MPS will not assume any legal responsibility for any said applications.