

Description

The FDC604P is the high cell density trenched P-channel MOSFETs, which provide excellent RDSON and gate charge for most of the synchronous buck converter applications.

The FDC604P meet the RoHS and Green Product requirement with full function reliability approved.

- Super Low Gate Charge
- Green Device Available
- Excellent CdV/dt effect decline
- Advanced high cell density Trench
- technology

Product Summary

- $V_{DS} = -20V$ $I_D = -6.0A$
- $R_{DS(ON)} < 35m\Omega$ @ $V_{GS}=10V$
- $R_{DS(ON)} < 53 m\Omega$ @ $V_{GS} =4.5V$

Pin Assignment

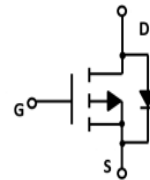
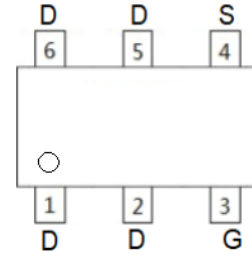

Absolute Maximum Ratings

Symbol	Parameter	Rating	Units
V_{DS}	Drain-Source Voltage	-20	V
V_{GS}	Gate-Source Voltage	± 12	V
$I_D @ T_A=25^\circ C$	Continuous Drain Current, $V_{GS} @ -4.5V^1$	-6.0	A
$I_D @ T_A=70^\circ C$	Continuous Drain Current, $V_{GS} @ -4.5V^1$	-3.0	A
I_{DM}	Pulsed Drain Current ²	-16	A
$P_D @ T_A=25^\circ C$	Total Power Dissipation ³	1.31	W
$P_D @ T_A=70^\circ C$	Total Power Dissipation ³	0.84	W
T_{STG}	Storage Temperature Range	-55 to 150	$^\circ C$
T_J	Operating Junction Temperature Range	-55 to 150	$^\circ C$

Electrical Characteristics (T_J=25°C unless otherwise specified)

Symbol	Parameter	Test Condition	Min.	Typ.	Max.	Units
Off Characteristic						
V _{(BR)DSS}	Drain-Source Breakdown Voltage	V _{GS} =0V, I _D = -250μA	-20			V
I _{DSS}	Zero Gate Voltage Drain Current	V _{DS} = -20V, V _{GS} =0V,			-1	μA
I _{GSS}	Gate to Body Leakage Current	V _{DS} =0V, V _{GS} = ±12V			±100	nA
On Characteristics						
V _{GS(th)}	Gate Threshold Voltage	V _{DS} =V _{GS} , I _D = -250μA	-0.4	-0.7	-1.0	V
R _{DS(on)}	Static Drain-Source on-Resistance <small>note2</small>	V _{GS} = -4.5V, I _D = -4.1A		28	35	mΩ
		V _{GS} = -2.5V, I _D = -3A	-	38	53	
Dynamic Characteristics						
C _{iss}	Input Capacitance	V _{DS} = -10V, V _{GS} =0V, f=1.0MHz		830		pF
C _{oss}	Output Capacitance			132		pF
C _{rss}	Reverse Transfer Capacitance			85		pF
Q _g	Total Gate Charge	V _{DS} = -10V, I _D = -2A, V _{GS} = -4.5V		8.8		nC
Q _{gs}	Gate-Source Charge			1.4		nC
Q _{gd}	Gate-Drain("Miller") Charge			1.9		nC
Switching Characteristics						
t _{d(on)}	Turn-on Delay Time	V _{DD} = -10V, I _D = -3.3A, R _G = 1Ω, V _{GEN} = -4.5V		10		ns
t _r	Turn-on Rise Time			32		ns
t _{d(off)}	Turn-off Delay Time			50		ns
t _f	Turn-off Fall Time			51		ns
Drain-Source Diode Characteristics and Maximum Ratings						
I _S	Maximum Continuous Drain to Source Diode Forward Current				-5.0	A
I _{SM}	Maximum Pulsed Drain to Source Diode Forward Current				-16	A
V _{SD}	Drain to Source Diode Forward Voltage	V _{GS} =0V, I _S = -4.1A			-1.2	V

Notes:1. Repetitive Rating: Pulse Width Limited by Maximum Junction Temperature

2. Pulse Test: Pulse Width≤300μs, Duty Cycle≤2%

Typical Performance Characteristics

Figure 1: Output Characteristics

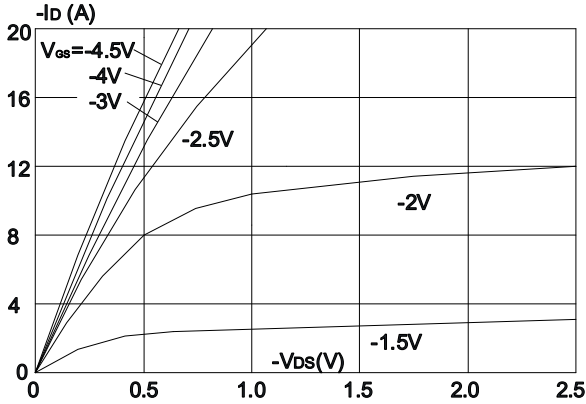

Figure 2: Typical Transfer Characteristics

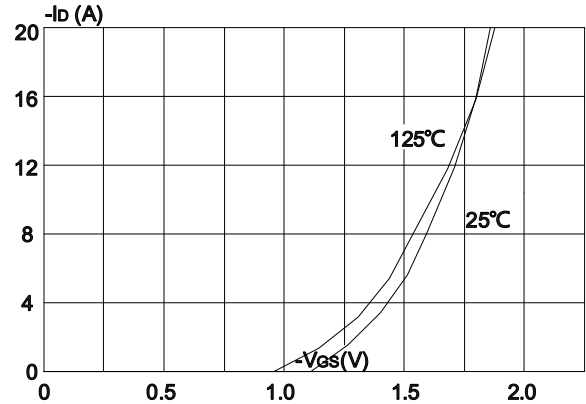

Figure 3: On-resistance vs. Drain Current

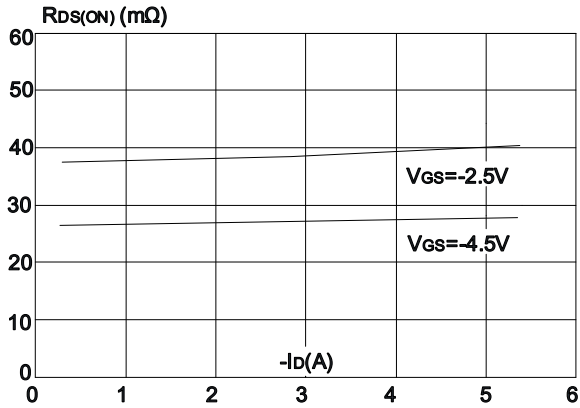

Figure 4: Body Diode Characteristics

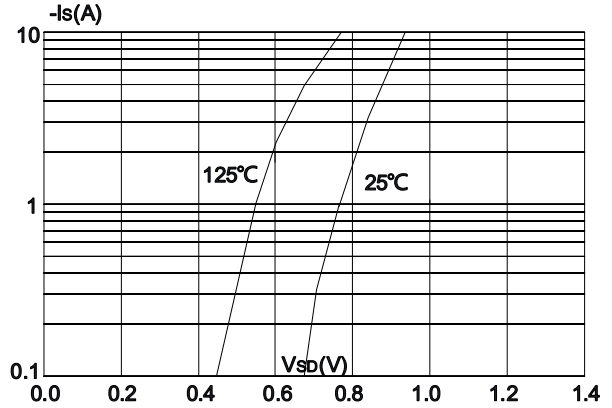

Figure 5: Gate Charge Characteristics

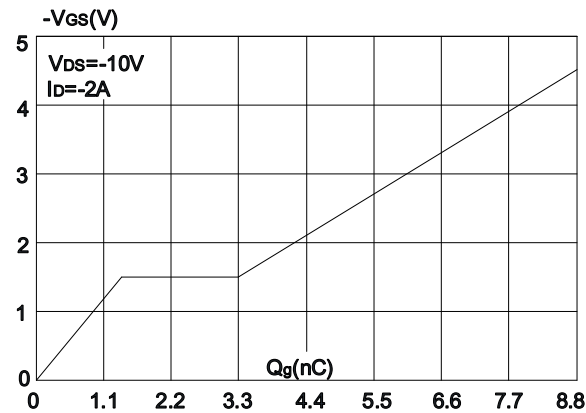

Figure 6: Capacitance Characteristics

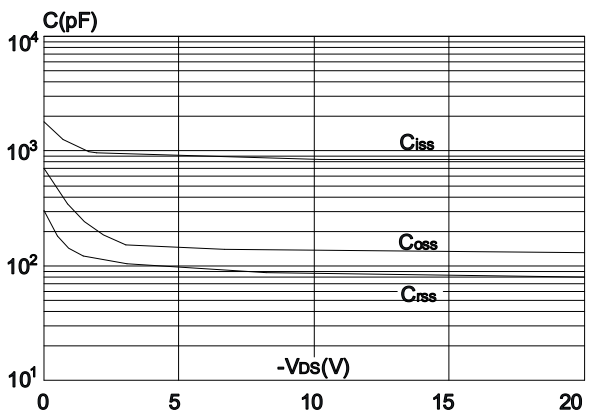

Figure 7: Normalized Breakdown Voltage vs. Junction Temperature

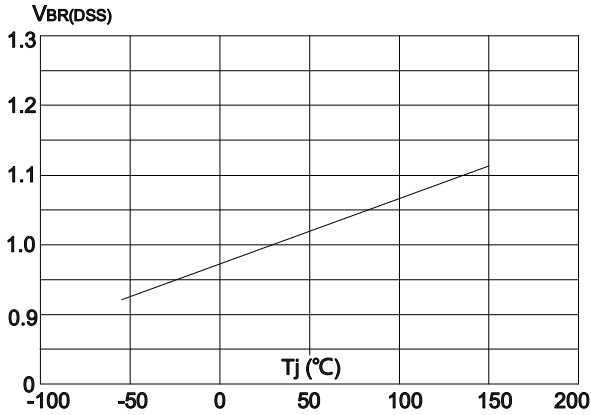

Figure 8: Normalized on Resistance vs. Junction Temperature

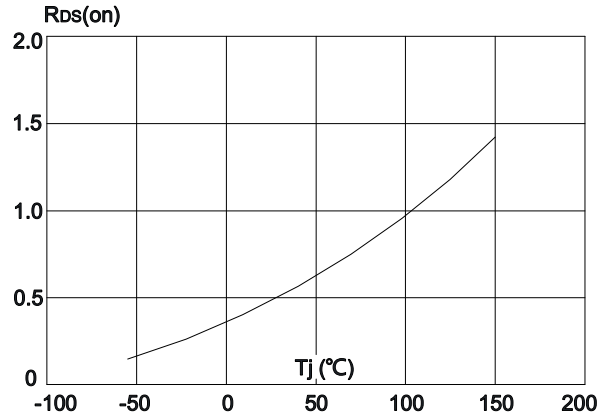

Figure 9: Maximum Safe Operating Area

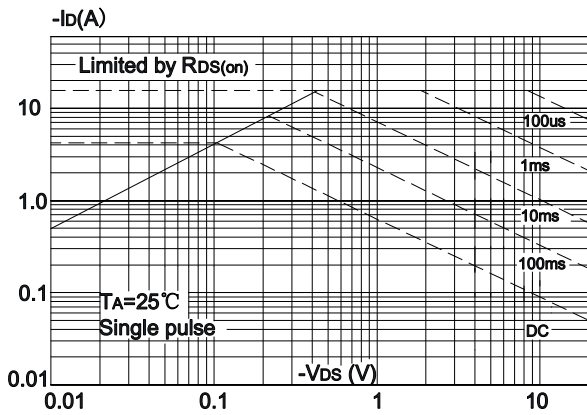

Figure 10: Maximum Continuous Drain Current vs. Ambient Temperature

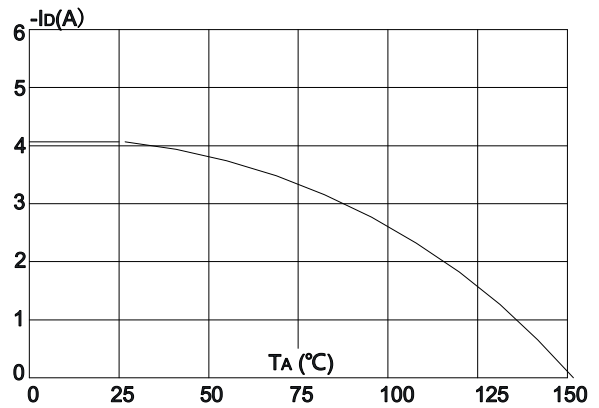
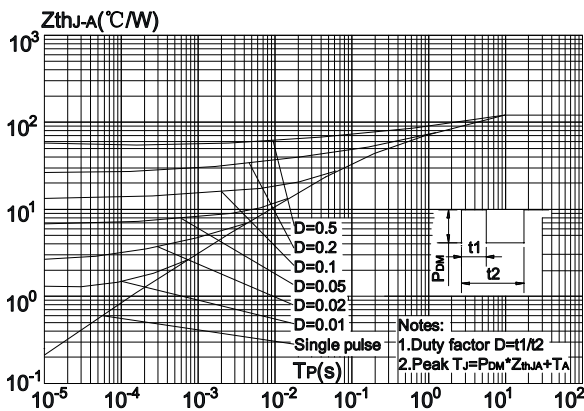
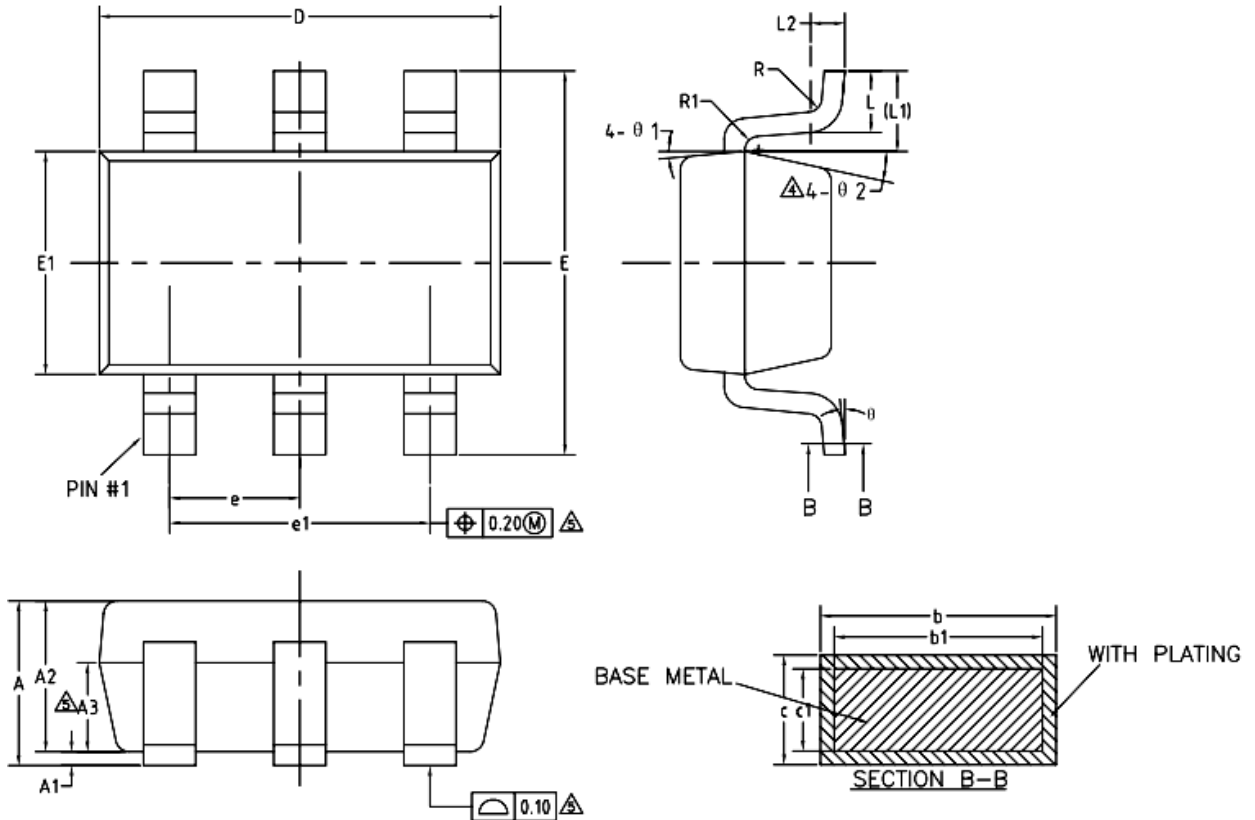

Figure.11: Maximum Effective Transient Thermal Impedance, Junction-to-Ambient



Package Dimension

SOT23-6



COMMON DIMENSIONS
(UNITS OF MEASURE=MILLIMETER)

SYMBOL	MIN	NOM	MAX
A	-	-	1.25
A1	0	-	0.15
A2	1.00	1.10	1.20
A3	0.60	0.65	0.70
b	0.36	-	0.50
b1	0.36	0.38	0.45
c	0.14	-	0.20
c1	0.14	0.15	0.16
D	2.826	2.926	3.026
E	2.60	2.80	3.00
E1	1.526	1.626	1.726
e	0.90	0.95	1.00
e1	1.80	1.90	2.00
L	0.35	0.45	0.60
L1	0.59REF		
L2	0.25BSC		
R	0.10	-	-
R1	0.10	-	0.20
theta	0°	-	8°
theta 1	3°	5°	7°
theta 2	6°	-	14°

Ordering information

Order code	Package	Baseqty	Deliverymode
UMW FDC604P	SOT23-6	3000	Tape and reel