

■ Features

- Glass passivated chip
- 400 W peak pulse power capability with a 10/1000 us waveform, repetitive rate (duty cycle):0.01 %
- Excellent clamping capability
- Low reverse leakage
- Very fast response time
- Lead and body according with RoHS standard

■ Mechanical Data

- Case: SMA/DO-214AC Molded plastic
- Lead: Solderable per MIL-STD-750, method 2026
- Epoxy: UL 94V-0 rate flame retardant
- Polarity: Color band denotes cathode end except Bipolar
- Mounting position: Any

SMA/DO-214AC

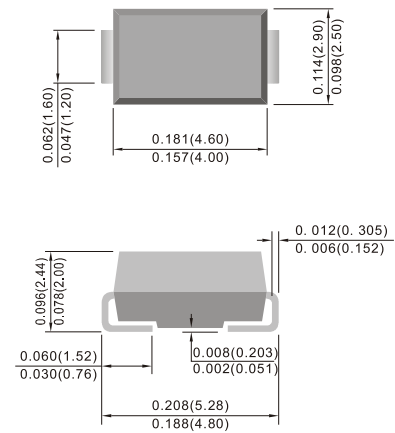

Dimensions: inch[mm]

Uni-directional

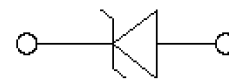

Bi-directional



■ Absolute Maximum Ratings ($T_A=25^{\circ}\text{C}$ unless otherwise noted)

Parameter	Symbol	Value	Unit
Peak power dissipation with a 10/1000 us waveform ⁽¹⁾	P _{PP}	400	W
Peak pulse current with a 10/1000 us waveform ⁽¹⁾	I _{PP}	43.8	A
Power dissipation on infinite heatsink at T _L = 75 °C	P _D	1.0	W
Peak forward surge current, 8.3 ms single half sinewave unidirectional only(2)	I _{FSM}	40	A
Maximum instantaneous forward voltage at 10 A for unidirectional only	V _F	3.5/5.0	V
Operating junction and storage temperature range	T _J , T _{STG}	-55 to +150	°C

Note:

1)Non-repetitive current pulse per Fig.5 and derated above T_A= 25 °C per Fig.1 ;

2)Measured on 8.3 ms single half sine-wave or equivalent square wave, duty cycle = 4 pulses per minute maximum ;

■ Electrical Characteristics ($T_A = 25^{\circ}\text{C}$ unless otherwise noted)

Part Number		Device Marking Code		Reverse Stand-off Voltage	Breakdown Voltage V _{BR} @ I _T		Test Current	Max. Clamping Voltage @ I _{PP}	Max. Peak Pulse Current	Max. Reverse Leakage @ V _{RWM}
UNI-POLAR	BI-POLAR	UNI	BI	V _{RWM} (V)	Min.(V)	Max.(V)	I _T (mA)	V _C MAX.(V)	I _{PP} (A)	I _R (uA)
SMAJ3.3A	SMAJ3.3CA	DA	DY	3.3	5.20	6.50	10	8.0	43.80	600



■ Ratings and Characteristics Curves ($T_A = 25^\circ\text{C}$ unless otherwise noted)

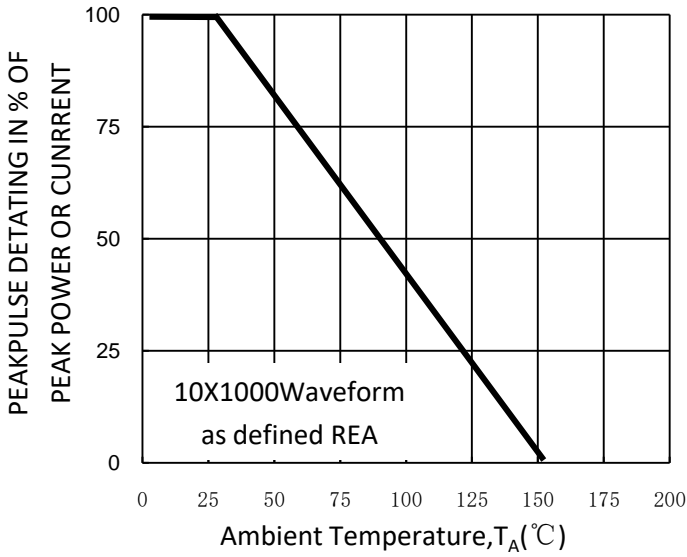

Fig. 1-Pulse Derating Curve

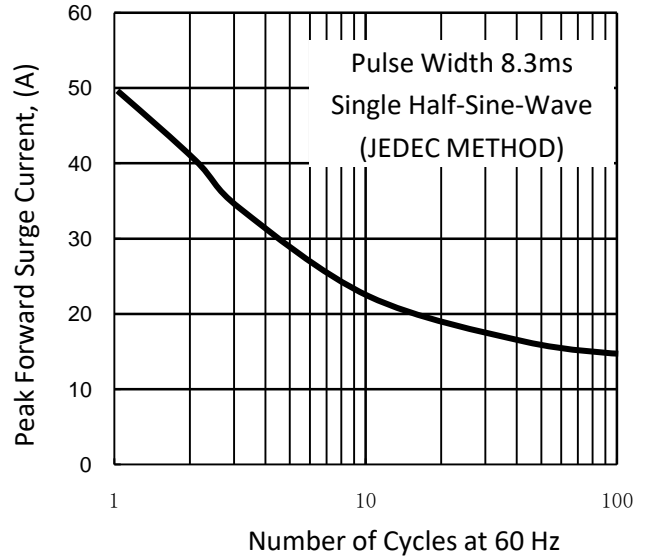

Fig. 2-Maximum Non-Repetitive Surge Current

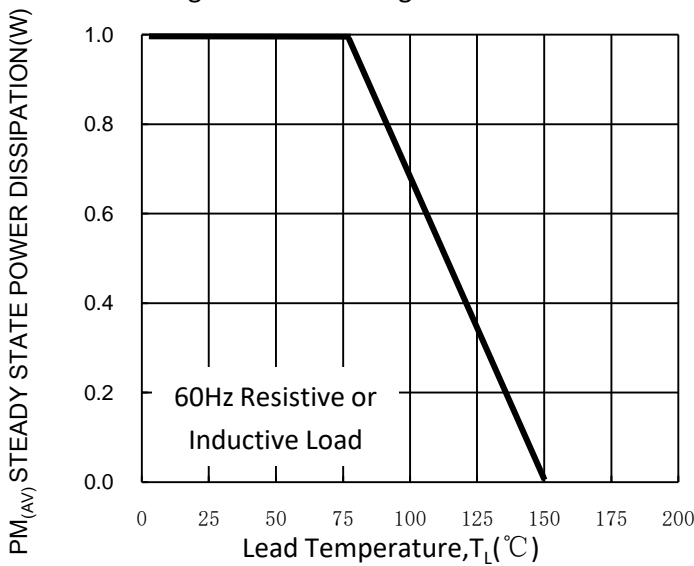

Fig. 3-Steady State Power Derating Curve

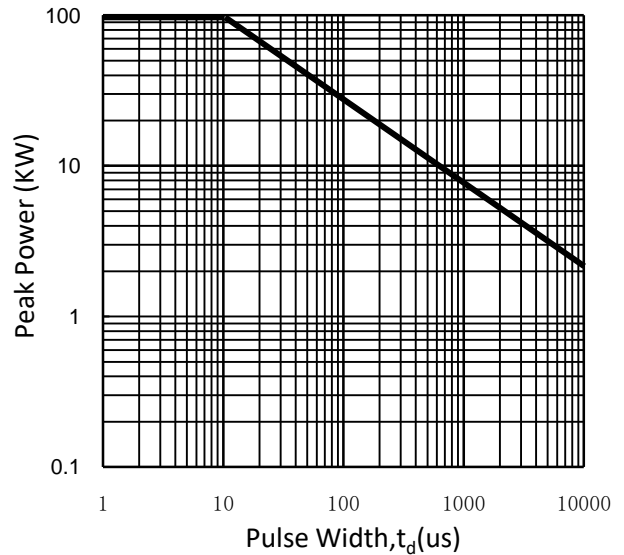

Fig. 4-Peak Pulse Power Rating Curve

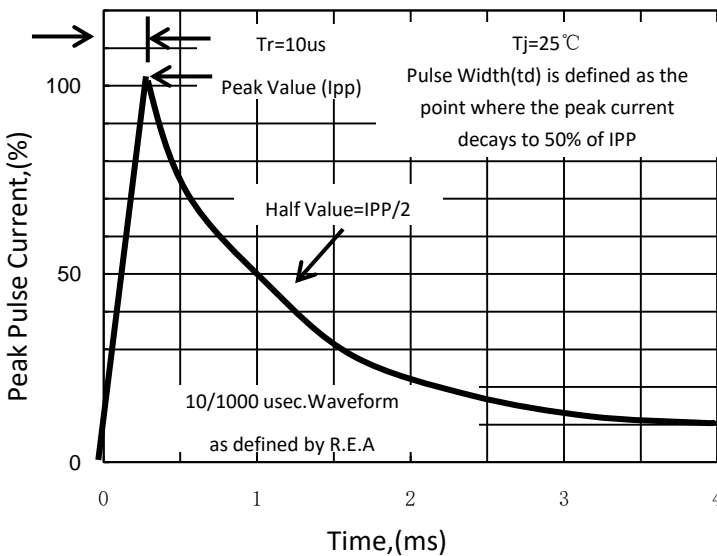

Fig. 5-Pulse Waveform

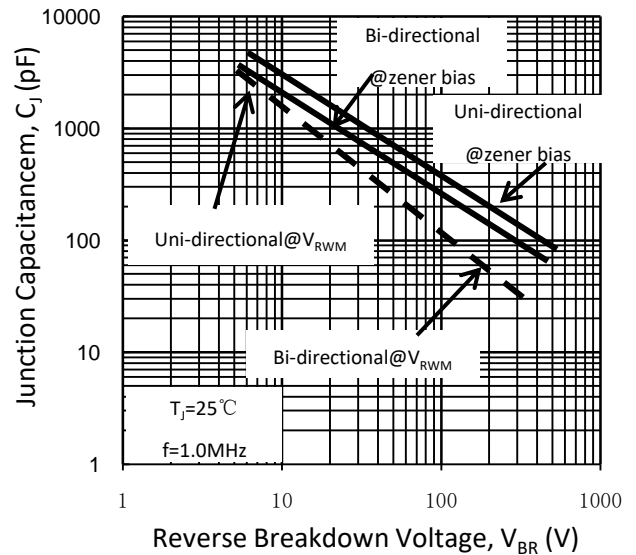

Fig. 6-Typical Junction Capacitance