

### DESCRIPTION

The OPA338 series rail-to-rail output CMOS operational amplifiers are designed for low cost and miniature applications.

OPA338 op amps provide low bias current, highspeed operation, high open-loop gain, and rail-to-rail output swing. They operate on a single supply with operation as low as 2.5V while drawing only 525µA quiescent current. In addition, the input common-mode voltage range includes ground—ideal for single-supply operation.

The OPA338 series is optimized for gains greater than or equal to 5. They are easy-to-use and free from phase inversion and overload problems found in some other op amps. Excellent performance is maintained as the amplifiers swing to their specified limits. The dual versions feature completely independent circuitry for lowest crosstalk and freedom from interaction, even when overdriven or overloaded.

### FEATURES

- SINGLE-SUPPLY OPERATION
- RAIL-TO-RAIL OUTPUT SWING
- FET-INPUT:  $I_B = 10\text{pA max}$
- HIGH SPEED:  
OPA337: 3MHz, 1.2V/µs (G = 1)  
OPA338: 12.5MHz, 4.6V/µs (G = 5)
- OPERATION FROM 2.5V to 5.5V
- HIGH OPEN-LOOP GAIN: 120dB
- LOW QUIESCENT CURRENT: 525µA/amp
- SINGLE AND DUAL VERSIONS

### APPLICATIONS

- BATTERY-POWERED INSTRUMENTS
- PHOTODIODE PRE-AMPS
- MEDICAL INSTRUMENTS
- TEST EQUIPMENT
- AUDIO SYSTEMS
- DRIVING ADCs
- CONSUMER PRODUCTS

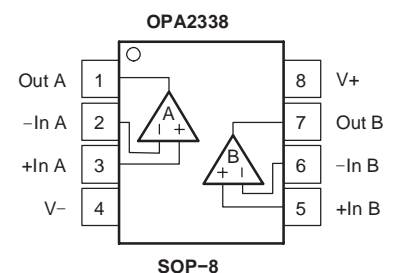
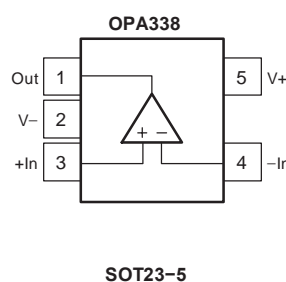
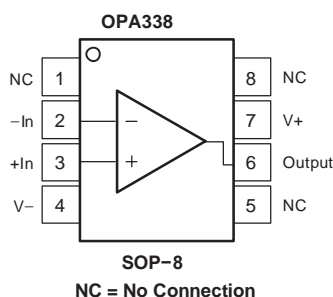

### ELECTRICAL CHARACTERISTICS: $V_S = 2.7V$ to $5.5V$

**Boldface** limits apply over the specified temperature range,  $-40^\circ C$  to  $+85^\circ C$ ,  $V_S = 5V$ .

At  $T_A = +25^\circ C$  and  $R_L = 25k\Omega$  connected to  $V_S/2$ , unless otherwise noted.

PARAMETER	CONDITION	OPA338, OPA2338			UNIT
		MIN	TYP(1)	MAX	
<b>OFFSET VOLTAGE</b>					
Input Offset Voltage	$V_{OS}$		$\pm 0.5$	$\pm 3$	mV
$T_A = -40^\circ C$ to $+85^\circ C$				$\pm 3.5$	mV
vs Temperature	$dV_{OS}/dT$		$\pm 2$		$\mu V/^\circ C$
vs Power-Supply Rejection Ratio	PSRR	$V_S = 2.7V$ to $5.5V$	25	125	$\mu V/V$
$T_A = -40^\circ C$ to $+85^\circ C$		$V_S = 2.7V$ to $5.5V$		125	$\mu V/V$
Channel Separation (dual versions)	dc		0.3		$\mu V/V$
<b>INPUT BIAS CURRENT</b>					
Input Bias Current	$I_B$		$\pm 0.2$	$\pm 10$	pA
$T_A = -40^\circ C$ to $+85^\circ C$			See Typical Curve		
Input Offset Current	$I_{OS}$		$\pm 0.2$	$\pm 10$	pA
<b>NOISE</b>					
Input Voltage Noise, $f = 0.1Hz$ to $10Hz$			6		$\mu V_{pp}$
Input Voltage Noise Density, $f = 1kHz$	$e_n$		26		$nV/\sqrt{Hz}$
Current Noise Density, $f = 1kHz$	$i_n$		0.6		$fA/\sqrt{Hz}$
<b>INPUT VOLTAGE RANGE</b>					
Common-Mode Voltage Range	$V_{CM}$	$T_A = -40^\circ C$ to $+85^\circ C$	-0.2		$(V+) - 1.2$
Common-Mode Rejection Ratio	CMRR	$-0.2V < V_{CM} < (V+) - 1.2V$	74	90	dB
$T_A = -40^\circ C$ to $+85^\circ C$		$-0.2V < V_{CM} < (V+) - 1.2V$	74		dB
<b>INPUT IMPEDANCE</b>					
Differential			$10^{13}    2$		$\Omega    pF$
Common-Mode			$10^{13}    4$		$\Omega    pF$
<b>OPEN-LOOP GAIN</b>					
Open-Loop Voltage Gain	$A_{OL}$	$R_L = 25k\Omega, 125mV < V_O < (V+) - 125mV$	100	120	dB
$T_A = -40^\circ C$ to $+85^\circ C$		$R_L = 25k\Omega, 125mV < V_O < (V+) - 125mV$	100		dB
		$R_L = 5k\Omega, 500mV < V_O < (V+) - 500mV$	100	114	dB
$T_A = -40^\circ C$ to $+85^\circ C$		$R_L = 5k\Omega, 500mV < V_O < (V+) - 500mV$	100		dB
<b>OPA338 FREQUENCY RESPONSE</b>					
Gain-Bandwidth Product	GBW	$V_S = 5V, G = 5$		12.5	MHz
Slew Rate	SR	$V_S = 5V, G = 5$		4.6	$V/\mu s$
Settling Time: 0.1%		$V_S = 5V, 2V$ Step, $C_L = 100pF, G = 5$		1.4	$\mu s$
0.01%		$V_S = 5V, 2V$ Step, $C_L = 100pF, G = 5$		1.9	$\mu s$
Overload Recovery Time		$V_{IN} \times G = V_S$		0.5	$\mu s$
Total Harmonic Distortion + Noise	THD+N	$V_S = 5V, V_O = 3V_{pp}, G = 5, f = 1kHz$		0.0035	%

(1)  $V_S = 5V$ .

(2) Output voltage swings are measured between the output and negative and positive power-supply rails.

### ELECTRICAL CHARACTERISTICS: $V_S = 2.7V$ to $5.5V$ (continued)

**Boldface** limits apply over the specified temperature range,  $-40^{\circ}C$  to  $+85^{\circ}C$ ,  $V_S = 5V$ .

At  $T_A = +25^{\circ}C$  and  $R_L = 25k\Omega$  connected to  $V_S/2$ , unless otherwise noted.

PARAMETER	CONDITION	OPA338, OPA2338			UNIT	
		MIN	TYP(1)	MAX		
<b>OUTPUT</b>						
Voltage Output Swing from Rail <sup>(2)</sup>	$R_L = 25k\Omega, A_{OL} \geq 100dB$		40	125	mV	
$T_A = -40^{\circ}C$ to $+85^{\circ}C$	$R_L = 25k\Omega, A_{OL} \geq 100dB$			125	mV	
	$R_L = 5k\Omega, A_{OL} \geq 100dB$		150	500	mV	
$T_A = -40^{\circ}C$ to $+85^{\circ}C$	$R_L = 5k\Omega, A_{OL} \geq 100dB$			500	mV	
Short-Circuit Current			$\pm 9$		mA	
Capacitive Load Drive		See Typical Curve				
<b>POWER SUPPLY</b>						
Specified Voltage Range	$V_S$	$T_A = -40^{\circ}C$ to $+85^{\circ}C$	2.7		5.5	V
Minimum Operating Voltage				2.5		V
Quiescent Current (per amplifier)	$I_Q$	$I_O = 0$		0.525	1	mA
$T_A = -40^{\circ}C$ to $+85^{\circ}C$		$I_O = 0$			1.2	mA
<b>TEMPERATURE RANGE</b>						
Specified Range			-40		+85	$^{\circ}C$
Operating Range			-55		+125	$^{\circ}C$
Storage Range			-55		+125	$^{\circ}C$
Thermal Resistance	$\theta_{JA}$					
SO-8 Surface-Mount				150		$^{\circ}C/W$

(1)  $V_S = 5V$ .

(2) Output voltage swings are measured between the output and negative and positive power-supply rails.

**TYPICAL CHARACTERISTICS**

At  $T_A = +25^\circ\text{C}$ ,  $V_S = +5\text{V}$ , and  $R_L = 25\text{k}\Omega$  connected to  $V_S/2$ , unless otherwise noted.

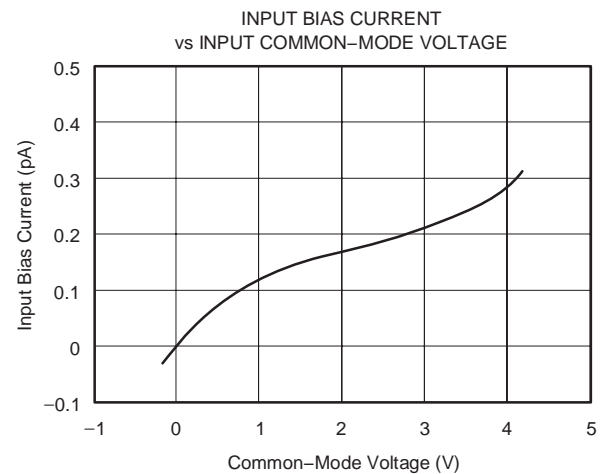
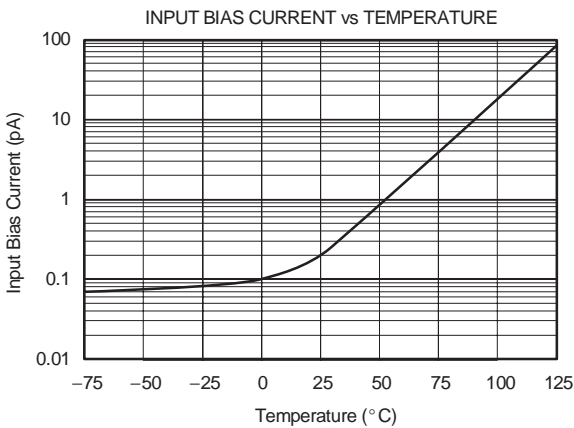
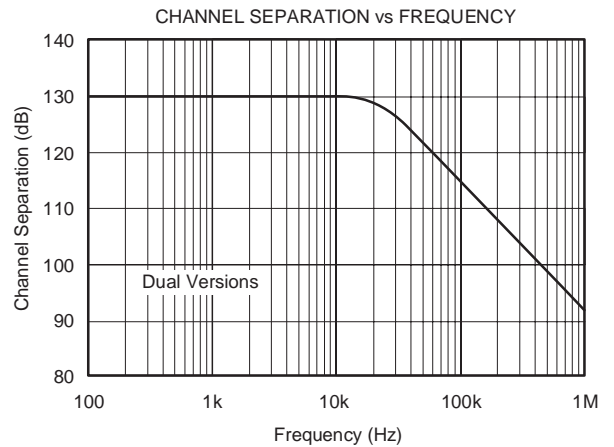
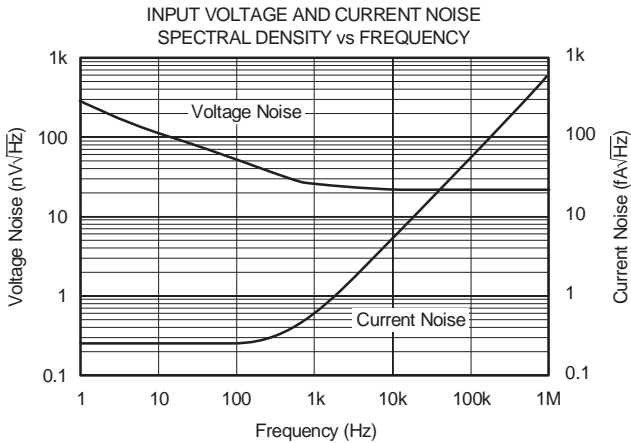
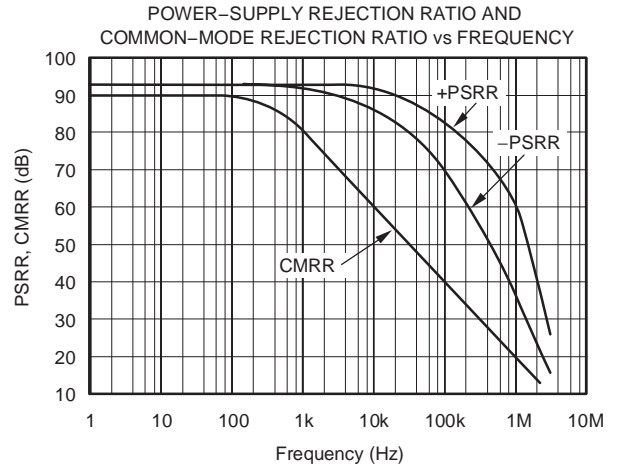
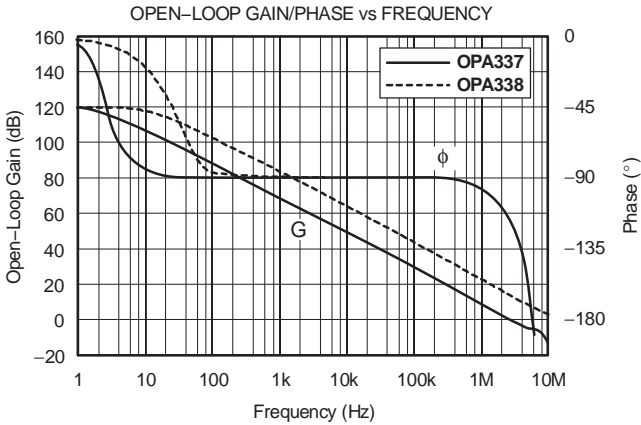

**TYPICAL CHARACTERISTICS (continued)**

At  $T_A = +25^\circ\text{C}$ ,  $V_S = +5\text{V}$ , and  $R_L = 25\text{k}\Omega$  connected to  $V_S/2$ , unless otherwise noted.

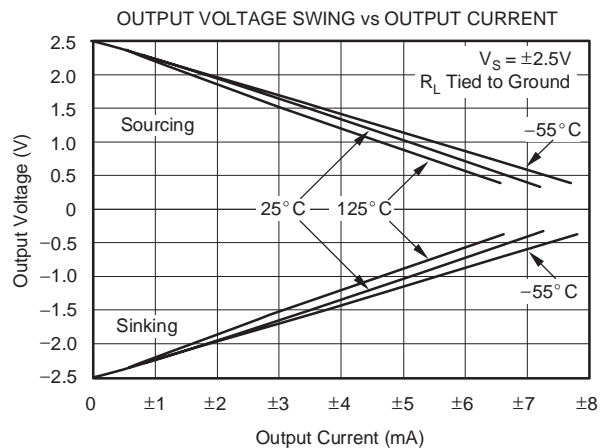
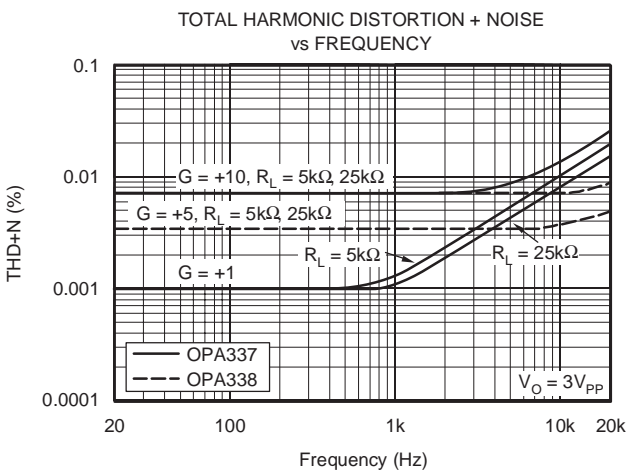
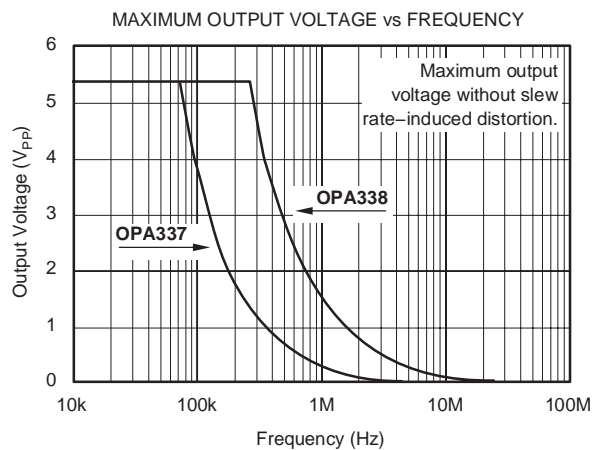
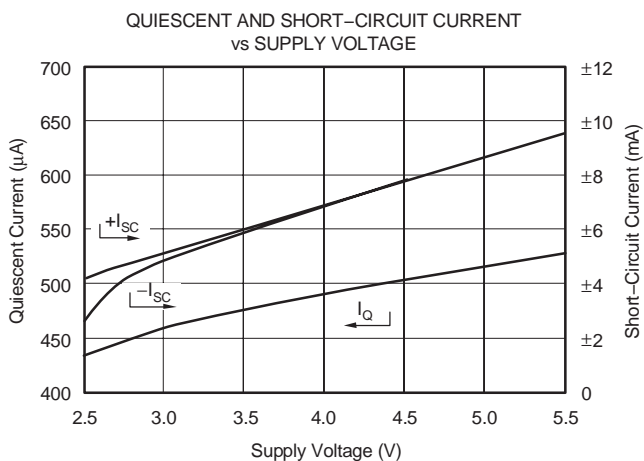
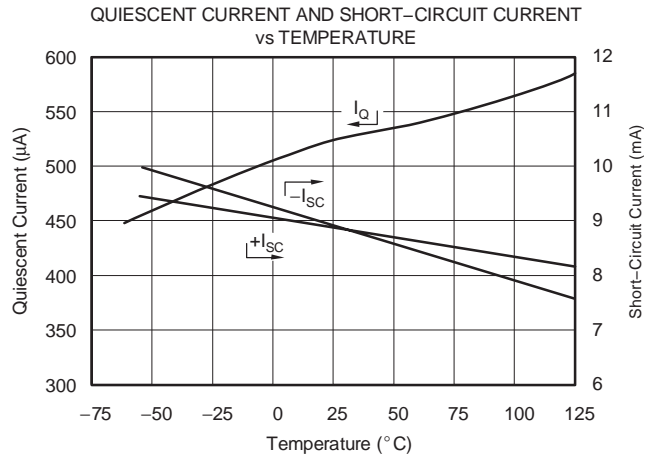
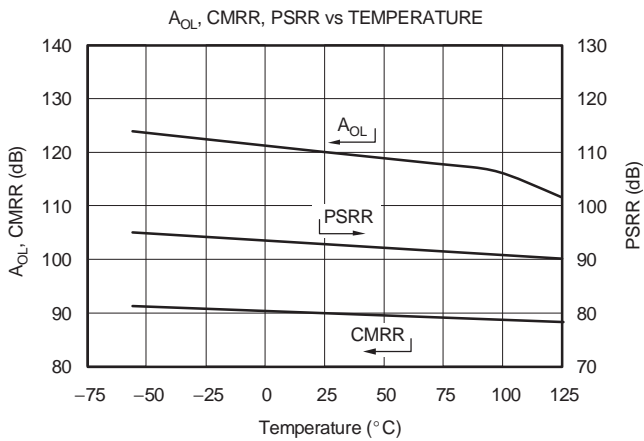

**TYPICAL CHARACTERISTICS (continued)**

At  $T_A = +25^\circ\text{C}$ ,  $V_S = +5\text{V}$ , and  $R_L = 25\text{k}\Omega$  connected to  $V_S/2$ , unless otherwise noted.

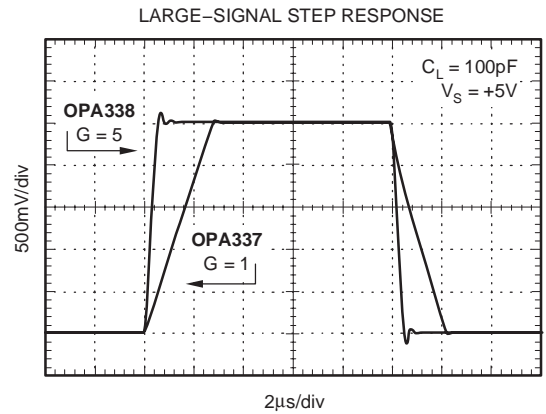
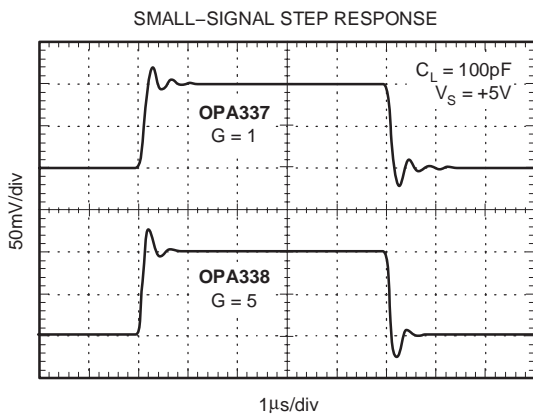
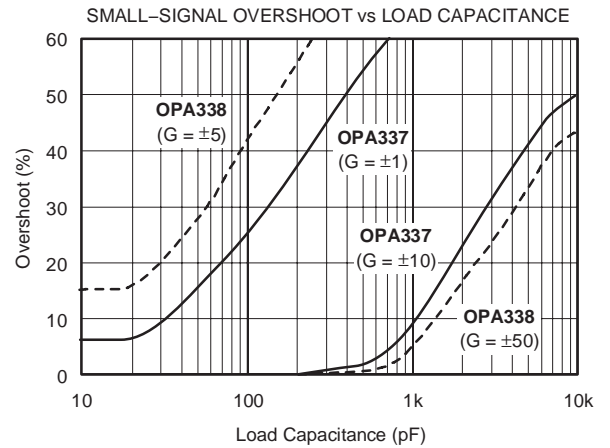
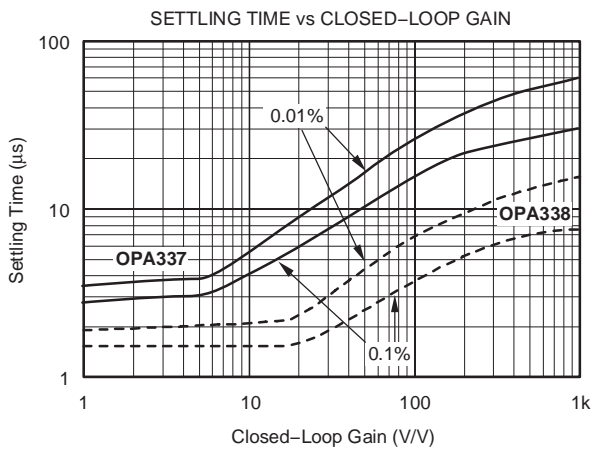
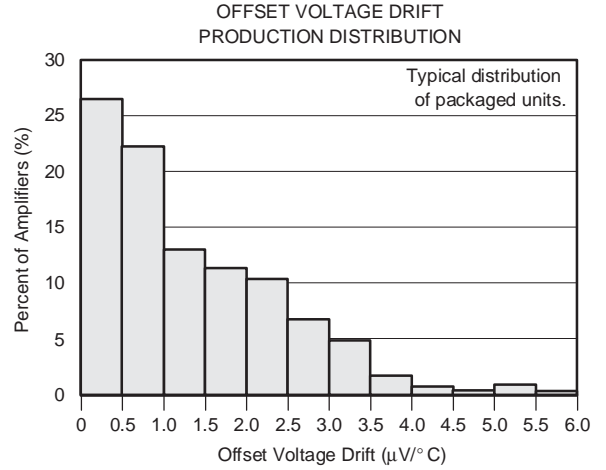
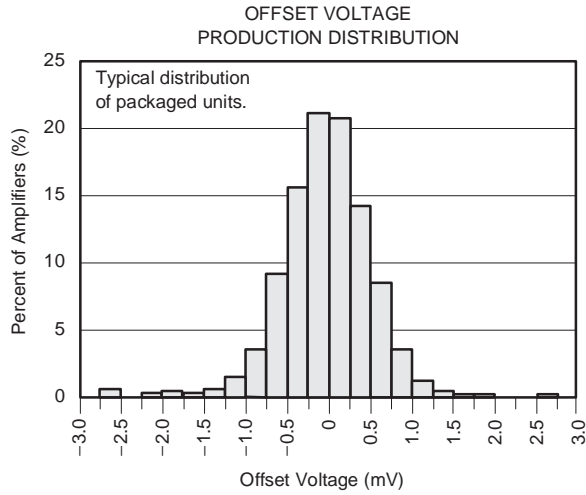

Package Dimension

SOP-8

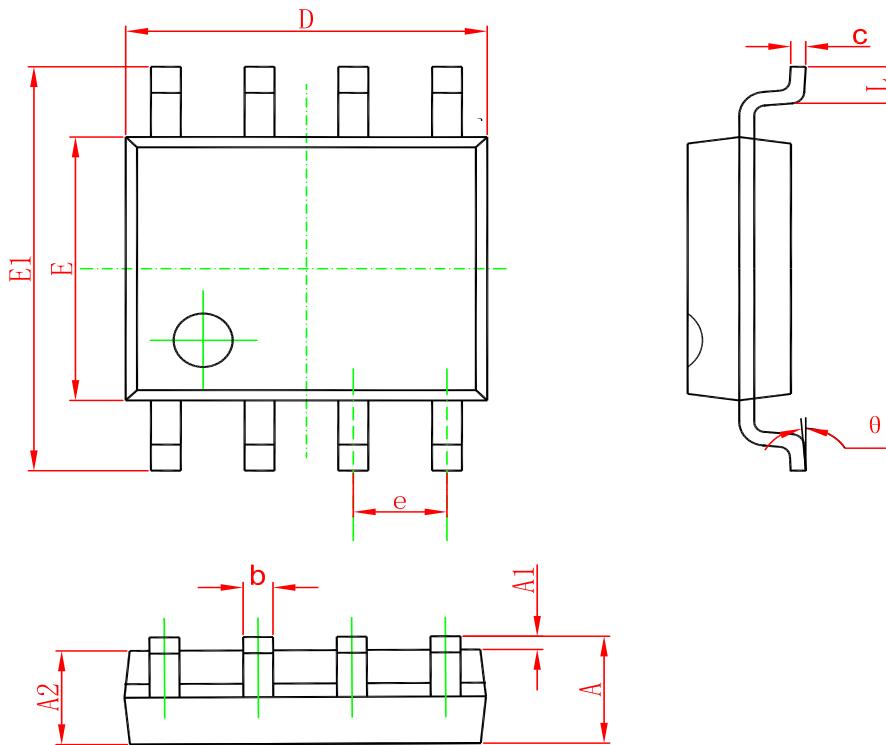

Symbol	Dimensions In Millimeters		Dimensions In Inches	
	Min	Max	Min	Max
A	1.350	1.750	0.053	0.069
A1	0.100	0.250	0.004	0.010
A2	1.350	1.550	0.053	0.061
b	0.330	0.510	0.013	0.020
c	0.170	0.250	0.006	0.010
D	4.700	5.100	0.185	0.200
E	3.800	4.000	0.150	0.157
E1	5.800	6.200	0.228	0.244
e	1.270(BSC)		0.050(BSC)	
L	0.400	1.270	0.016	0.050
θ	0°	8°	0°	8°

SOT23-5

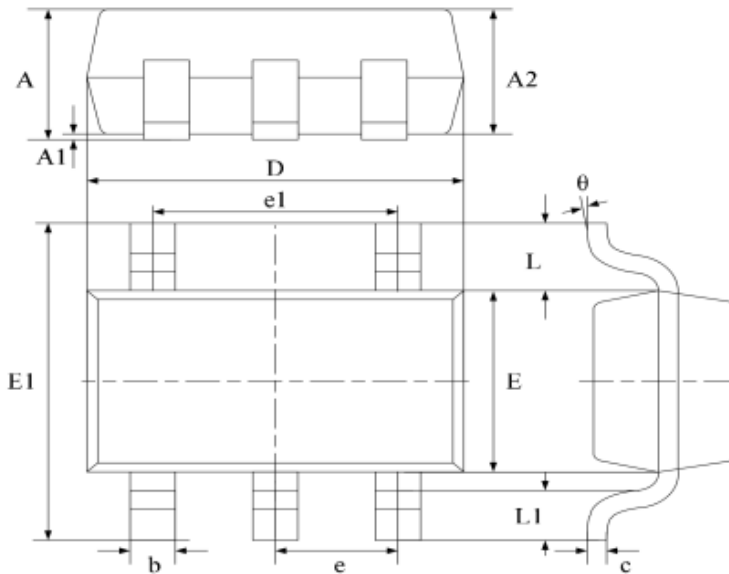

Symbol	Dimensions In Millimeters		Dimensions In Inches	
	Min	Max	Min	Max
A	1.040	1.350	0.042	0.055
A1	0.040	0.150	0.002	0.006
A2	1.000	1.200	0.041	0.049
b	0.380	0.480	0.015	0.020
c	0.110	0.210	0.004	0.009
D	2.720	3.120	0.111	0.127
E	1.400	1.800	0.057	0.073
E1	2.600	3.000	0.106	0.122
e	0.950 typ.		0.037 typ.	
e1	1.900 typ.		0.078 typ.	
L	0.700 ref.		0.028 ref.	
L1	0.300	0.600	0.012	0.024
θ	0°	8°	0°	8°

Ordering information

Order code	Package	Baseqty	Deliverymode	Marking
UMW OPA338NA	SOT23-5	3000	Tape and reel	A38 U
UMW OPA2338UA	SOP-8	2500	Tape and reel	OPA2338UA
UMW OPA338UA	SOP-8	2500	Tape and reel	OPA338UA