

## Description

The TSV631 devices are single operational amplifiers offering low voltage, low power operation, and rail-to-rail input and output.

These devices have a very low input bias current and a low offset voltage making them ideal for applications that require precision. They can operate at power supplies ranging from 1.5 V to 5.5 V, and are therefore very suitable for battery-powered devices, extending battery life.

These op-amps feature an excellent speed/power consumption ratio, offering an 880 kHz gain bandwidth while consuming only 60  $\mu$ A at a 5 V supply voltage. They are unity gain stable for capacitive loads up to 100 pF.

The devices are internally adjusted to provide very narrow dispersion of AC and DC micropackages and are guaranteed for industrial temperature ranges from -40 °C to 125 °C.

## Features

- Low offset voltage: 500  $\mu$ V max (A version)
- Low power consumption: 60  $\mu$ A typ at 5 V
- Low supply voltage: 1.5 V - 5.5 V
- Gain bandwidth product: 880 kHz typ
- Unity gain stability
- Low power shutdown mode: 5 nA typ
- High output current: 63 mA at  $V_{CC} = 5$  V
- Low input bias current: 1 pA typ
- Rail-to-rail input and output
- Extended temperature range: -40 °C to 125 °C

## Applications

- Battery-powered applications
- Portable devices
- Active filtering
- Medical instrumentation

## Package pin connections

Figure 1: Pin connections for each package (top view)

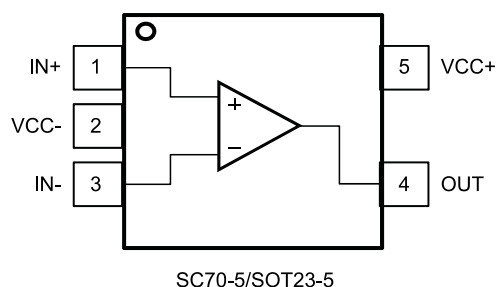

## Absolute maximum ratings and operating conditions

Symbol	Parameter	Value	Unit	
$V_{CC}$	Supply voltage	6	V	
$V_{id}$	Differential input voltage	$\pm V_{CC}$		
$V_{in}$	Input voltage	$(V_{CC-}) - 0.2$ to $(V_{CC+}) + 0.2$		
$I_{in}$	Input current	10	mA	
$\overline{SHDN}$	Shutdown voltage	6	V	
$T_{stg}$	Storage temperature	-65 to 150	$^{\circ}$ C	
$R_{thja}$	Thermal resistance junction-to-ambient	SC70-5	205	$^{\circ}$ C/W
		SOT23-5	250	
$T_j$	Maximum junction temperature	150	$^{\circ}$ C	

### Operating conditions

Symbol	Parameter	Value	Unit
$V_{CC}$	Supply voltage	1.5 to 5.5	V
$V_{icm}$	Common mode input voltage range	$(V_{CC-}) - 0.1$ to $(V_{CC+}) + 0.1$	
$T_{oper}$	Operating free air temperature range	-40 to 125	$^{\circ}$ C

## Electrical characteristics

Electrical characteristics at  $V_{CC+} = 1.8$  V with  $V_{CC-} = 0$  V,  $V_{icm} = V_{CC}/2$ ,  $T_{amb} = 25$  °C and  $R_L$  connected to  $V_{CC}/2$  (unless otherwise specified)

Symbol	Parameter	Conditions	Min.	Typ.	Max.	Unit
$V_{io}$	Offset voltage	TSV631			3	mV
		TSV631A			0.5	
		-40 °C < $T_{op}$ < 125 °C, TSV631			4.5	
		-40 °C < $T_{op}$ < 125 °C, TSV631A			2	
$\Delta V_{io}/\Delta T$	Input offset voltage drift			2		$\mu$ V/°C
$I_{io}$	Input offset current, $V_{out} = V_{CC}/2$			1	10	pA
		-40 °C < $T_{op}$ < 125 °C		1	100	
$I_{ib}$	Input bias current, $V_{out} = V_{CC}/2$			1	10	pA
		-40 °C < $T_{op}$ < 125 °C		1	100	
CMR	Common mode rejection ratio 20 log, $\Delta V_{ic}/\Delta V_{io}$	0 V to 1.8 V, $V_{out} = 0.9$ V	53	74		dB
		-40 °C < $T_{op}$ < 125 °C	51			
$A_{vd}$	Large signal voltage gain	$R_L = 10$ k $\Omega$ , $V_{out} = 0.5$ V to 1.3 V	85	95		dB
		-40 °C < $T_{op}$ < 125 °C	80			
$V_{OH}$	High level output voltage, $V_{OH} = V_{CC} - V_{out}$	$R_L = 10$ k $\Omega$		5	35	mV
		-40 °C < $T_{op}$ < 125 °C			50	
$V_{OL}$	Low level output voltage	$R_L = 10$ k $\Omega$		4	35	mV
		-40 °C < $T_{op}$ < 125 °C			50	
$I_{out}$	$I_{sink}$	$V_o = 1.8$ V	6	12		mA
		-40 °C < $T_{op}$ < 125 °C	4			
	$I_{source}$	$V_o = 0$ V	6	10		
		-40 °C < $T_{op}$ < 125 °C	4			
$I_{CC}$	Supply current, $\overline{SHDN} = V_{CC+}$	No load, $V_{out} = V_{CC}/2$	40	50	60	$\mu$ A
		-40 °C < $T_{op}$ < 125 °C			62	
GBP	Gain bandwidth product	$R_L = 2$ k $\Omega$ , $C_L = 100$ pF, $f = 100$ kHz	700	790		kHz
$\phi_m$	Phase margin	$R_L = 2$ k $\Omega$ , $C_L = 100$ pF		48		Degrees
$G_m$	Gain margin			11		dB
SR	Slew rate	$R_L = 2$ k $\Omega$ , $C_L = 100$ pF, $A_v = 1$	0.2	0.27		V/ $\mu$ s
$e_n$	Equivalent input noise voltage	$f = 1$ kHz		67		nV/ $\sqrt{Hz}$
		$f = 10$ kHz		53		

**Shutdown characteristics VCC = 1.8 V**

Symbol	Parameter	Conditions	Min.	Typ.	Max.	Unit
$I_{CC}$	Supply current in shutdown mode (all operators)	$\overline{\text{SHDN}} = V_{CC-}$		2.5	50	nA
		$-40\text{ }^{\circ}\text{C} < T_{op} < 85\text{ }^{\circ}\text{C}$			200	
		$-40\text{ }^{\circ}\text{C} < T_{op} < 125\text{ }^{\circ}\text{C}$			1.5	$\mu$ A
$t_{on}$	Amplifier turn-on time	$R_L = 2\text{ k}\Omega$ , $V_{out} = (V_{CC-}) + 0.2\text{ V}$ to $(V_{CC+}) - 0.2\text{ V}$		300		ns
$t_{off}$	Amplifier turn-off time	$R_L = 2\text{ k}\Omega$ , $V_{out} = (V_{CC-}) + 0.2\text{ V}$ to $(V_{CC+}) - 0.2\text{ V}$		20		
$V_{IH}$	$\overline{\text{SHDN}}$ logic high		1.3			V
$V_{IL}$	$\overline{\text{SHDN}}$ logic low				0.5	
$I_{IH}$	$\overline{\text{SHDN}}$ current high	$\overline{\text{SHDN}} = V_{CC+}$		10		pA
$I_{IL}$	$\overline{\text{SHDN}}$ current low	$\overline{\text{SHDN}} = V_{CC-}$		10		
$I_{OLeak}$	Output leakage in shutdown mode	$\overline{\text{SHDN}} = V_{CC-}$		50		
		$-40\text{ }^{\circ}\text{C} < T_{op} < 125\text{ }^{\circ}\text{C}$		1		nA

Electrical characteristics at  $V_{CC+} = 3.3$  V,  $V_{CC-} = 0$  V,  $V_{icm} = V_{CC}/2$ ,  $T_{amb} = 25$  °C,  $R_L$  connected to  $V_{CC}/2$  (unless otherwise specified)

Symbol	Parameter	Conditions	Min.	Typ.	Max.	Unit
$V_{io}$	Offset voltage	TSV631			3	mV
		TSV631A			0.5	
		-40 °C < $T_{op}$ < 125 °C, TSV631			4.5	
		-40 °C < $T_{op}$ < 125 °C, TSV631A			2	
$\Delta V_{io}/\Delta T$	Input offset voltage drift			2		$\mu$ V/°C
$I_{io}$	Input offset current			1	10	pA
		-40 °C < $T_{op}$ < 125 °C		1	100	
$I_{ib}$	Input bias current			1	10	pA
		-40 °C < $T_{op}$ < 125 °C		1	100	
CMR	Common mode rejection ratio 20 log, $\Delta V_{ic}/\Delta V_{io}$	0 V to 3.3 V, $V_{out} = 1.75$ V	57	79		dB
		-40 °C < $T_{op}$ < 125 °C	53			
$A_{vd}$	Large signal voltage gain	$R_L = 10$ k $\Omega$ , $V_{out} = 0.5$ V to 2.8 V	88	98		dB
		-40 °C < $T_{op}$ < 125 °C	83			
$V_{OH}$	High level output voltage, $V_{OH} = V_{CC} - V_{out}$	$R_L = 10$ k $\Omega$		6	35	mV
		-40 °C < $T_{op}$ < 125 °C			50	
$V_{OL}$	Low level output voltage	$R_L = 10$ k $\Omega$		7	35	mV
		-40 °C < $T_{op}$ < 125 °C			50	
$I_{out}$	$I_{sink}$	$V_o = 3.3$ V	30	45		mA
		-40 °C < $T_{op}$ < 125 °C	25	42		
	$I_{source}$	$V_o = 0$ V	30	38		
		-40 °C < $T_{op}$ < 125 °C	25			
$I_{CC}$	Supply current, $\overline{SHDN} = V_{CC+}$	No load, $V_{out} = 1.75$ V	43	55	64	$\mu$ A
		-40 °C < $T_{op}$ < 125 °C			66	
GBP	Gain bandwidth product	$R_L = 2$ k $\Omega$ , $C_L = 100$ pF, $f = 100$ kHz	710	860		kHz
$\phi_m$	Phase margin	$R_L = 2$ k $\Omega$ , $C_L = 100$ pF		50		Degrees
$G_m$	Gain margin			11		dB
SR	Slew rate	$R_L = 2$ k $\Omega$ , $C_L = 100$ pF, $A_v = 1$	0.22	0.29		V/ $\mu$ s
$e_n$	Equivalent input noise voltage	$f = 1$ kHz		64		nV/ $\sqrt{Hz}$
		$f = 10$ kHz		51		

Electrical characteristics at  $V_{CC+} = 5$  V with  $V_{CC-} = 0$  V,  $V_{icm} = V_{CC}/2$ ,  $T_{amb} = 25^\circ$  C and  $R_L$  connected to  $V_{CC}/2$  (unless otherwise specified)

Symbol	Parameter	Conditions	Min.	Typ.	Max.	Unit
$V_{io}$	Offset voltage	TSV631			3	mV
		TSV631A			0.5	
		-40 $^\circ$ C < $T_{op}$ < 125 $^\circ$ C, TSV631			4.5	
		-40 $^\circ$ C < $T_{op}$ < 125 $^\circ$ C, TSV631A			2	
$\Delta V_{io}/\Delta T$	Input offset voltage drift			2		$\mu$ V/ $^\circ$ C
$I_{io}$	Input offset current, $V_{out} = V_{CC}/2$			1	10	pA
		-40 $^\circ$ C < $T_{op}$ < 125 $^\circ$ C			1	
$I_{ib}$	Input bias current, $V_{out} = V_{CC}/2$			1	10	pA
		-40 $^\circ$ C < $T_{op}$ < 125 $^\circ$ C			1	
CMR	Common mode rejection ratio 20 log, $\Delta V_{ic}/\Delta V_{io}$	0 V to 5 V, $V_{out} = 2.5$ V	60	80		dB
		-40 $^\circ$ C < $T_{op}$ < 125 $^\circ$ C	55			
SVR	Supply voltage rejection ratio 20 log, $\Delta V_{CC}/\Delta V_{io}$	$V_{CC} = 1.8$ to 5 V	75	102		dB
		-40 $^\circ$ C < $T_{op}$ < 125 $^\circ$ C				
$A_{vd}$	Large signal voltage gain	$R_L = 10$ k $\Omega$ , $V_{out} = 0.5$ V to 4.5 V	89	98		
		-40 $^\circ$ C < $T_{op}$ < 125 $^\circ$ C	84			
$V_{OH}$	High level output voltage, $V_{OH} = V_{CC} - V_{out}$	$R_L = 10$ k $\Omega$		7	35	mV
		-40 $^\circ$ C < $T_{op}$ < 125 $^\circ$ C			50	
$V_{OL}$	Low level output voltage	$R_L = 10$ k $\Omega$		6	35	mV
		-40 $^\circ$ C < $T_{op}$ < 125 $^\circ$ C			50	
$I_{out}$	$I_{sink}$	$V_o = 5$ V	40	69		mA
		-40 $^\circ$ C < $T_{op}$ < 125 $^\circ$ C	35	65		
	$I_{source}$	$V_o = 0$ V	40	74		
		-40 $^\circ$ C < $T_{op}$ < 125 $^\circ$ C	36	68		
$I_{CC}$	Supply current $\overline{SHDN} = V_{CC+}$	No load, $V_{out} = V_{CC}/2$	50	60	69	$\mu$ A
		-40 $^\circ$ C < $T_{op}$ < 125 $^\circ$ C			72	
GBP	Gain bandwidth product	$R_L = 2$ k $\Omega$ , $C_L = 100$ pF, $f = 100$ kHz	730	880		kHz
$F_u$	Unity gain frequency			830		
$\phi_m$	Phase margin	$R_L = 2$ k $\Omega$ , $C_L = 100$ pF,		50		Degrees
$G_m$	Gain margin			12		dB
SR	Slew rate	$R_L = 2$ k $\Omega$ , $C_L = 100$ pF, $A_v = 1$	0.25	0.34		V/ $\mu$ s
$e_n$	Equivalent input noise voltage	$f = 1$ kHz		60		nV/ $\sqrt$ Hz
		$f = 10$ kHz		47		

Symbol	Parameter	Conditions	Min.	Typ.	Max.	Unit
THD+e <sub>n</sub>	Total harmonic distortion	f = 1 kHz, A <sub>V</sub> = 1, R <sub>L</sub> = 100 k $\Omega$ , V <sub>icm</sub> = V <sub>CC</sub> /2, V <sub>out</sub> = 2 V <sub>PP</sub>		0.0017		%

**Notes:**

(1)Guaranteed by design.

**Shutdown characteristics VCC = 5 V**

Symbol	Parameter	Conditions	Min.	Typ.	Max.	Unit
<b>DC performance</b>						
I <sub>CC</sub>	Supply current in shutdown mode (all operators)	$\overline{\text{SHDN}} = V_{CC-}$		5	50	nA
		-40 °C < T <sub>op</sub> < 85 °C			200	
		-40 °C < T <sub>op</sub> < 125 °C				1.5
t <sub>on</sub>	Amplifier turn-on time	R <sub>L</sub> = 2 k $\Omega$ , V <sub>out</sub> = (V <sub>CC-</sub> ) + 0.2 V to (V <sub>CC+</sub> ) - 0.2 V		300		ns
t <sub>off</sub>	Amplifier turn-off time	R <sub>L</sub> = 2 k $\Omega$ , V <sub>out</sub> = (V <sub>CC-</sub> ) + 0.2 V to (V <sub>CC+</sub> ) - 0.2 V		30		
V <sub>IH</sub>	$\overline{\text{SHDN}}$ logic high		4.5			V
V <sub>IL</sub>	$\overline{\text{SHDN}}$ logic low				0.5	
I <sub>IH</sub>	$\overline{\text{SHDN}}$ current high	$\overline{\text{SHDN}} = V_{CC+}$		10		pA
I <sub>IL</sub>	$\overline{\text{SHDN}}$ current low	$\overline{\text{SHDN}} = V_{CC-}$		10		
I <sub>oLeak</sub>	Output leakage in shutdown mode	$\overline{\text{SHDN}} = V_{CC-}$		50		
		-40 °C < T <sub>op</sub> < 125 °C		1		nA

Figure 2: Supply current vs. supply voltage at  $V_{icm} = V_{CC}/2$

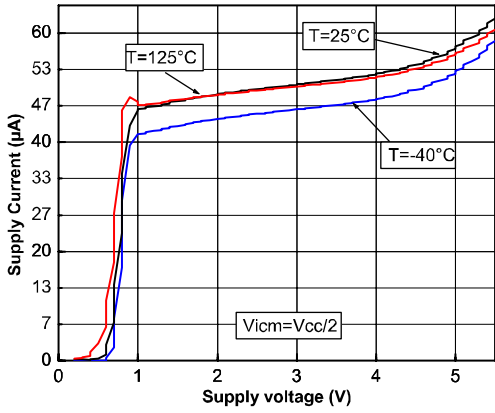

Figure 3: In-series resistor ( $R_{iso}$ ) vs. capacitive load

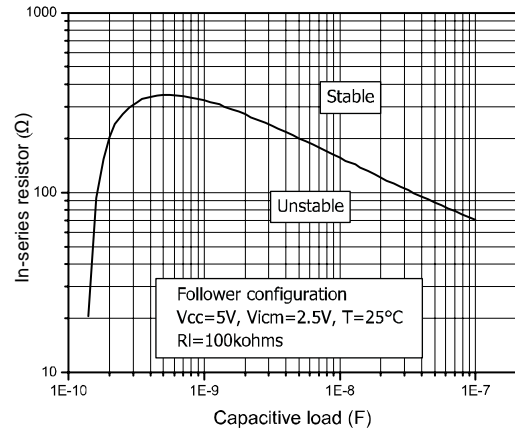

Figure 4: Output current vs. output voltage at  $V_{CC} = 5$  V

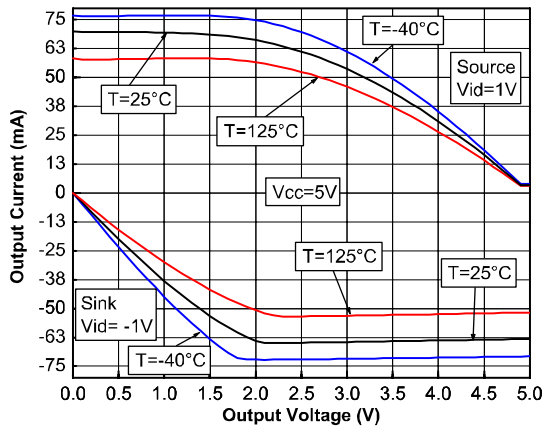

Figure 5: Voltage gain and phase vs. frequency at  $V_{CC} = 1.5$  V

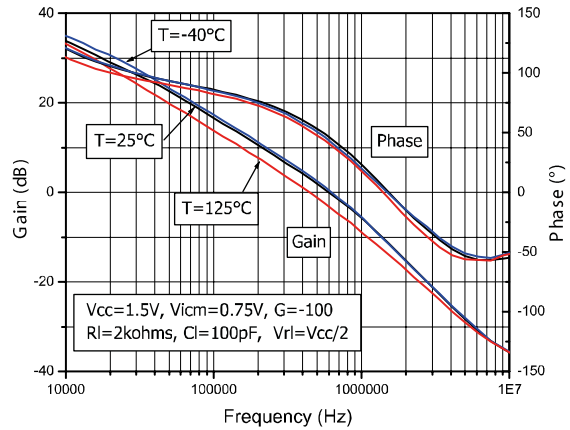

Figure 6: Voltage gain and phase vs. frequency at  $V_{CC} = 5$  V

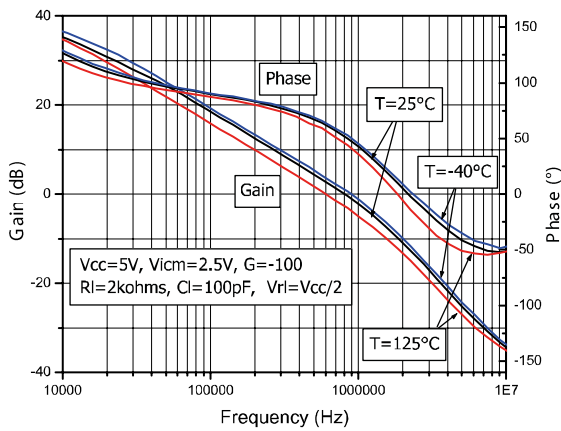

Figure 7: Phase margin vs. output current at  $V_{CC} = 5$  V

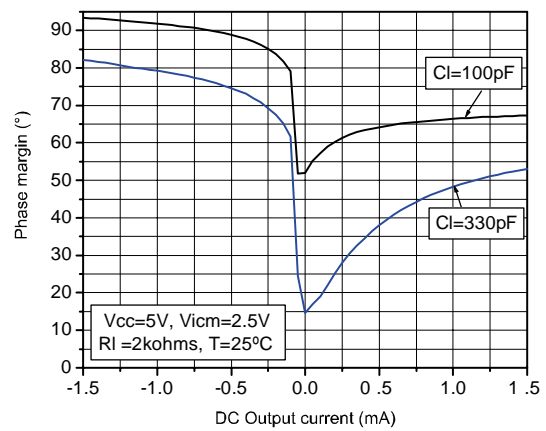



Figure 8: Positive slew rate vs. time

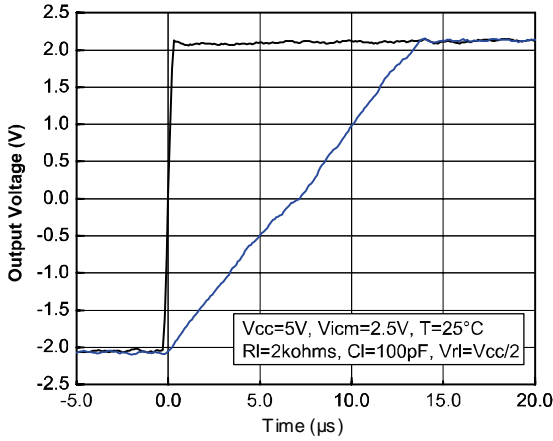

Figure 9: Negative slew rate vs. time

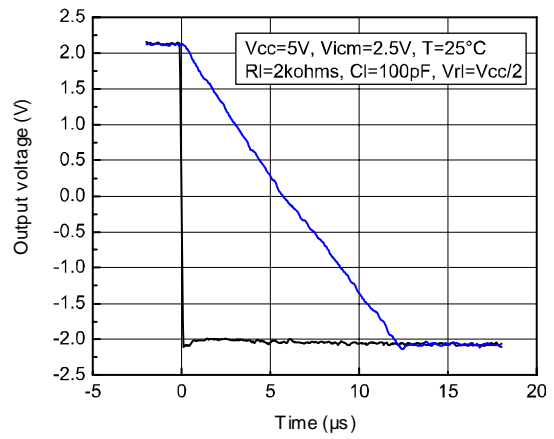

Figure 10: Positive slew rate vs. supply voltage

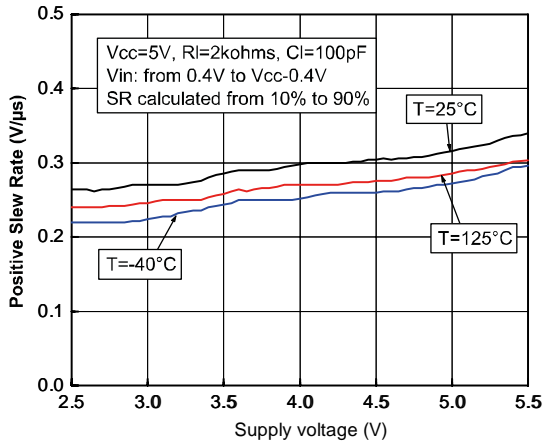

Figure 11: Negative slew rate vs. supply voltage

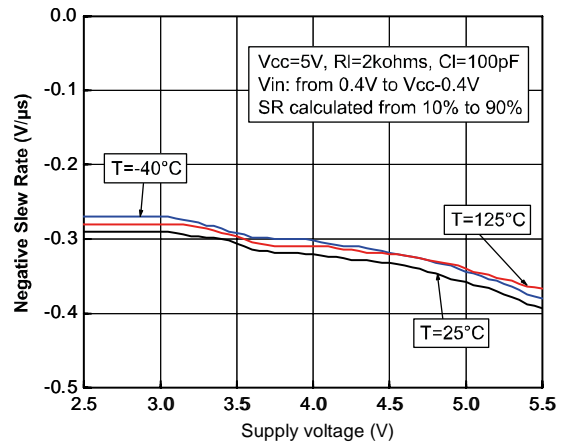

Figure 12: Distortion + noise vs. output voltage (RL = 2 k $\Omega$ )

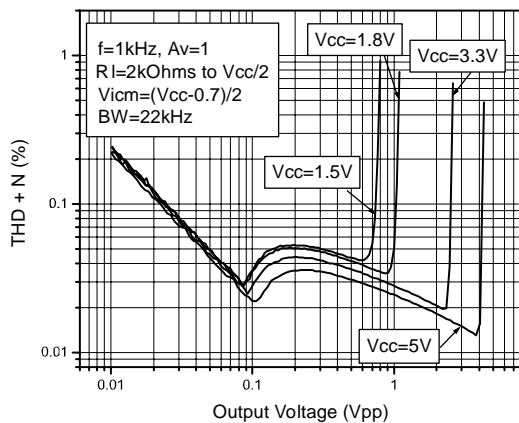

Figure 13: Distortion + noise vs. output voltage (RL = 100 k $\Omega$ )

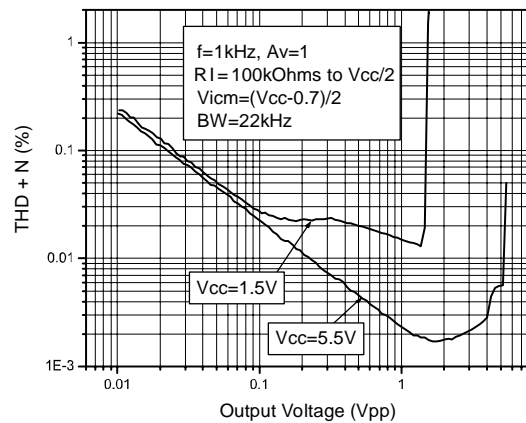

Figure 14: Distortion + noise vs. frequency and input voltage

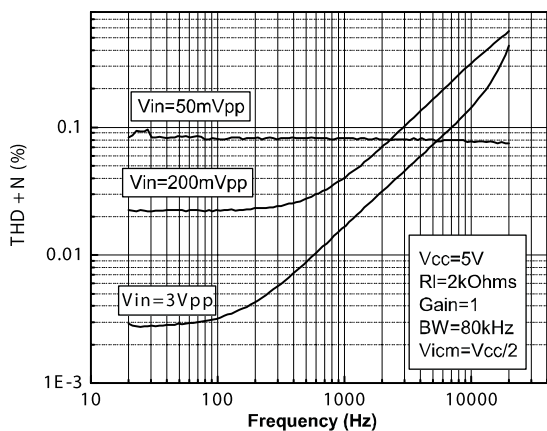

Figure 15: Distortion + noise vs. frequency and output load resistor

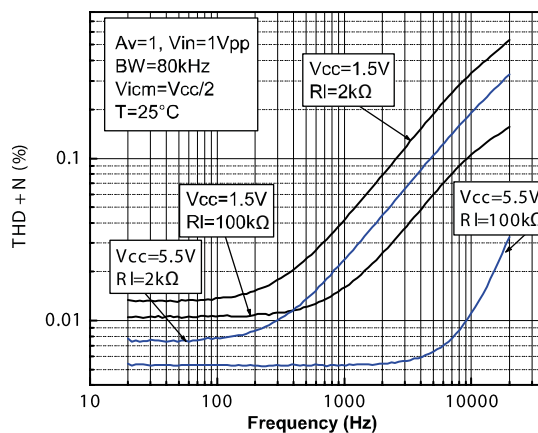

Figure 16: Noise vs. frequency

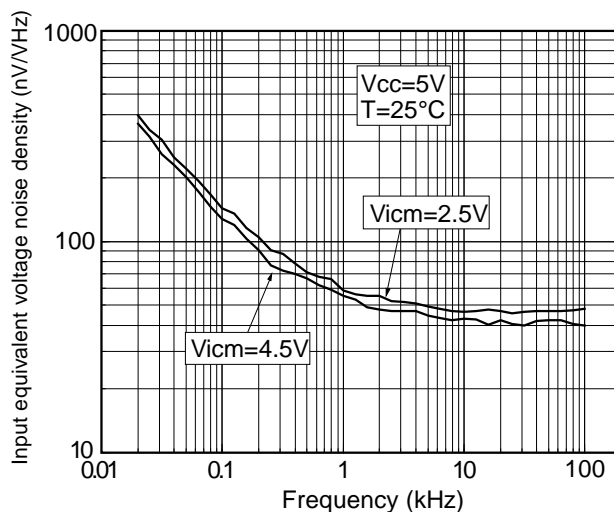

Figure 17: Input offset voltage vs input common mode at VCC = 1.5 V

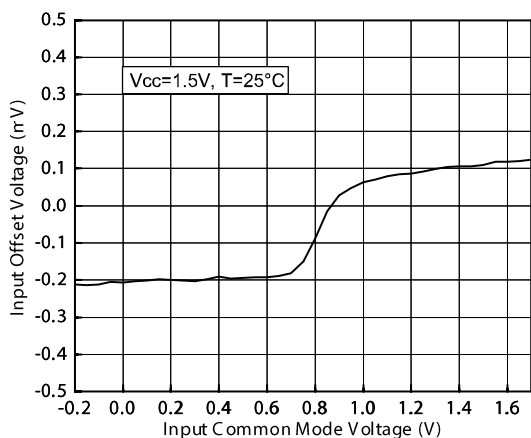

Figure 18: Input offset voltage vs input common mode at VCC = 5 V

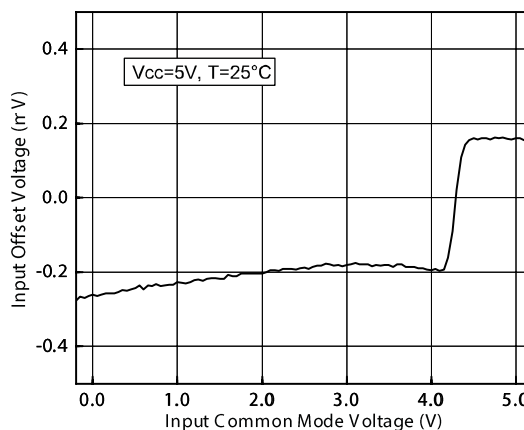
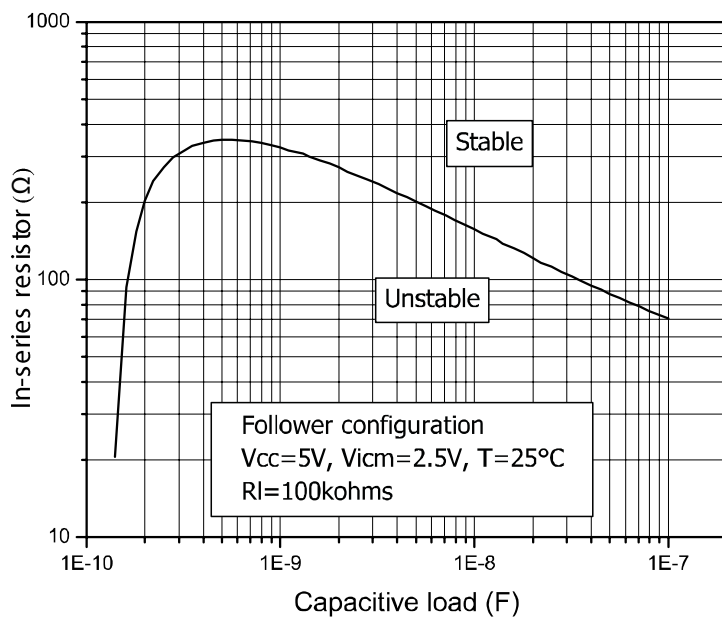
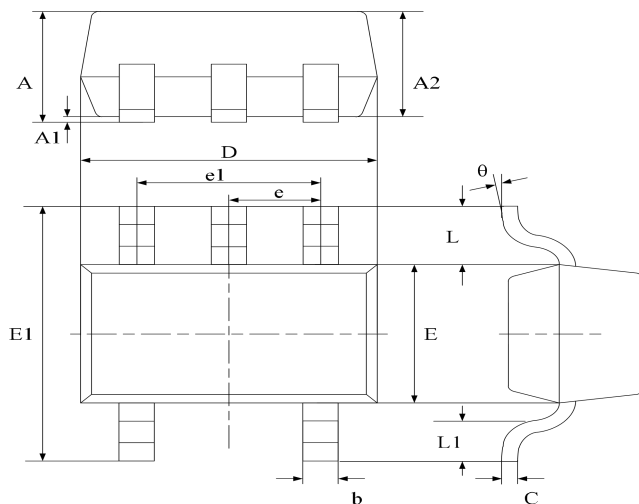

Figure 19: In-series resistor vs. capacitive load



## Package Information

### SC70-5 (SOT353)



Symbol	Dimensions In Millimeters		Dimensions In Inches	
	Min	Max	Min	Max
A	0.800	1.100	0.035	0.043
A1	0.000	0.100	0.000	0.004
A2	0.800	0.900	0.035	0.039
b	0.150	0.350	0.006	0.014
C	0.080	0.150	0.003	0.006
D	1.8500	2.150	0.079	0.087
E	1.100	1.400	0.045	0.053
E1	1.950	2.200	0.085	0.096
e	0.850 typ.		0.026 typ.	
e1	1.200	1.400	0.047	0.055
L	0.42 ref.		0.021 ref.	
L1	0.260	0.460	0.010	0.018
$\theta$	0°	8°	0°	8°

### SOT23-5

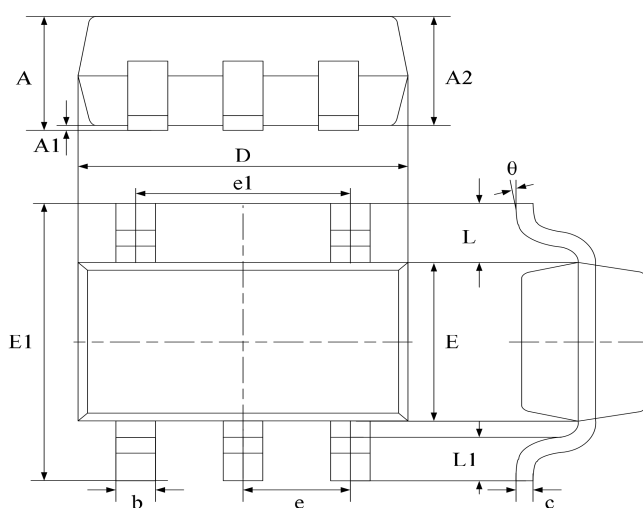

Symbol	Dimensions In Millimeters		Dimensions In Inches	
	Min	Max	Min	Max
A	1.040	1.350	0.042	0.055
A1	0.040	0.150	0.002	0.006
A2	1.000	1.200	0.041	0.049
b	0.380	0.480	0.015	0.020
c	0.110	0.210	0.004	0.009
D	2.720	3.120	0.111	0.127
E	1.400	1.800	0.057	0.073
E1	2.600	3.000	0.106	0.122
e	0.950 typ.		0.037 typ.	
e1	1.900 typ.		0.078 typ.	
L	0.700 ref.		0.028 ref.	
L1	0.300	0.600	0.012	0.024
$\theta$	0°	8°	0°	8°

**Ordering information**

<b>Order code</b>	<b>Package</b>	<b>Baseqty</b>	<b>Deliverymode</b>	<b>Marking</b>
UMW TSV631ICT	SC-70-5	3000	Tape and reel	K19 U
UMW TSV631AICT	SC-70-5	3000	Tape and reel	K42 U
UMW TSV631AILT	SOT23-5	3000	Tape and reel	K142 U
UMW TSV631ILT	SOT23-5	3000	Tape and reel	K109 U