

Description

The TP156X series are CMOS dual, and quad RRIO op-amps with low offset, low power and stable high frequency response. to achieve very good AC performance with 6MHz bandwidth, 4.5V/µs slew rate and low distortion while drawing only 600µA of quiescent current per amplifier. The input common-mode voltage range extends 300mV beyond V₋ and V₊, and the outputs swing rail-to-rail. The TP156X family can be used as plug-in replacements for many commercially available op-amps to reduce power and improve input/output range and performance.

The combination of features makes the TP156X ideal choices for motor control and portable audio amplification, sound ports, and other consumer Audio. The TP156X Op-amp is very stable, and it is capable of driving heavy capacitive loads such as those found in LCDs. The ability to swing rail-to-rail at the inputs and outputs enables designers to buffer CMOS DACs, ASICs, or other wide output swing devices in single-supply systems.

Features

- Supply Voltage: 2.5V to 6.0V
- Low Supply Current: 600µA per channel
- Rail to Rail Input and Output
- Bandwidth: 6 MHz
- Slew Rate: 4.5V/µs
- Excellent EMI Suppress Performance
- Offset Voltage: ±3mV Maximum
- Offset Voltage Temperature Drift: 1 µV/°C
- Low Noise: 19 nV/√Hz at 1kHz
- High Output Capability: 100mA
- -40°C to 125°C Operation Temperature Range

Applications

- White Goods
- Motor Control

Pin Configuration

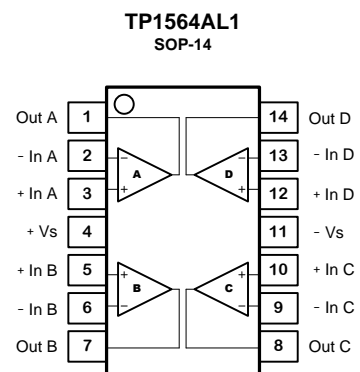
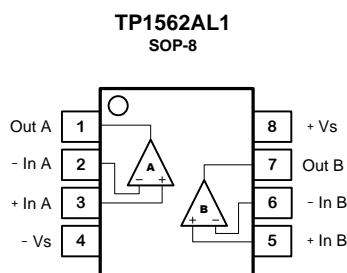
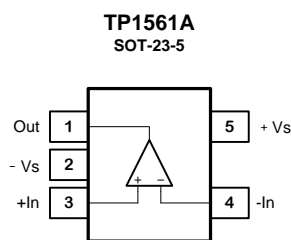

Absolute Maximum Ratings ^{Note 1}

Parameters	Rating
Supply Voltage, (+V _S)– (-V _S)	7 V
Input Voltage	(-V _S) – 0.3 to (+V _S) + 0.3
Differential Input Voltage	±7V
Input Current: +IN, –IN ^{Note 2}	±10mA
Output Short-Circuit Duration ^{Note 3}	Infinite
Maximum Junction Temperature	150°C
Operating Temperature Range	–40 to 125°C
Storage Temperature Range	–65 to 150°C
Lead Temperature (Soldering, 10 sec)	260°C

Note 1: Stresses beyond those listed under Absolute Maximum Ratings may cause permanent damage to the device. Exposure to any Absolute Maximum Rating condition for extended periods may affect device reliability and lifetime.

Note 2: The inputs are protected by ESD protection diodes to each power supply. If the input extends more than 300mV beyond the power supply, the input current should be limited to less than 10mA.

Note 3: A heat sink may be required to keep the junction temperature below the absolute maximum. This depends on the power supply voltage and how many amplifiers are shorted. Thermal resistance varies with the amount of PC board metal connected to the package. The specified values are for short traces connected to the leads.

ESD Rating

Symbol	Parameter	Condition	Minimum Level	Unit
HBM	Human Body Model ESD	MIL-STD-883H Method 3015.8	8	kV
CDM	Charged Device Model ESD	JEDEC-EIA/JESD22-C101E	2	kV

Thermal Information

Package Type	θ_{JA}	θ_{JC}	Unit
SOT23-5	250	81	°C/W
SOP-8	158	43	°C/W
SOP-14	120	36	°C/W

All test condition is $V_S = 5V$, $T_A = 25^\circ C$, $R_L = 2k\Omega$, $C_L = 100pF$, unless otherwise noted.

Symbol	Parameter	Conditions	Min	Typ	Max	Unit
V_S	Supply Voltage Range		2.5		6	V
I_Q	Quiescent Current per Amplifier			600	900	μA
PSRR	Power Supply Rejection Ratio		75	90		dB
V_{OS}	Input Offset Voltage	$V_{CM} = 0V$ to $3V$	-3		3	mV
$V_{OS\ TC}$	Input Offset Voltage Drift	$T_A = -40^\circ C$ to $125^\circ C$		1		μV/°C
I_B	Input Bias Current	$T_A = 25^\circ C$		1		pA
		$T_A = 85^\circ C$		25		pA
I_{OS}	Input Offset Current			1		pA
C_{IN}	Input Capacitance	Differential Mode		8		pF
		Common Mode		7		pF
A_V	Open-loop Voltage Gain	$R_{LOAD} = 10k\Omega$	80	100		dB
V_{CMR}			(V-) - 0.1		(V+) + 0.1	V
CMRR	Common Mode Rejection Ratio	$V_{CM} = 0V$ to $2.5V$	70	100		dB
Xtalk	Channel Separation	$f = 1kHz$, $R_L = 2k\Omega$		110		dB
V_{OH}, V_{OL}	Maximum Output Voltage Swing	$R_{LOAD} = 10k\Omega$		3	15	mV
I_{SC}	Output Short-Circuit Current		90	100		mA
GBW	Gain-Bandwidth Product			6		MHz
SR	Slew Rate	$A_V = 1$, $V_{OUT} = 1.5V$ to $3.5V$, $C_{LOAD} = 60pF$, $R_{LOAD} = 1k\Omega$		4.5		V/μs
t_s	Settling Time, 0.1%	$A_V = 1$, 2V Step, $C_{LOAD} = 60pF$, $R_{LOAD} = 1k\Omega$		0.8		μs
	Settling Time, 0.01%			1		μs
PM	Phase Margin	$R_{LOAD} = 1k\Omega$, $C_{LOAD} = 60pF$		60		°
GM	Gain Margin	$R_{LOAD} = 1k\Omega$, $C_{LOAD} = 60pF$		15		dB
E_N	Input Voltage Noise	$f = 0.1Hz$ to $10Hz$		8		μV _{PP}
e_N	Input Voltage Noise Density	$f = 1kHz$		19		nV/√Hz
i_N	Input Current Noise	$f = 1kHz$		2		fA/√Hz
THD+N	Total Harmonic Distortion and Noise			0.003		%

Typical Performance Characteristics

V_S = 5V, V_{CM} = 2.5V, R_L = Open, unless otherwise specified.

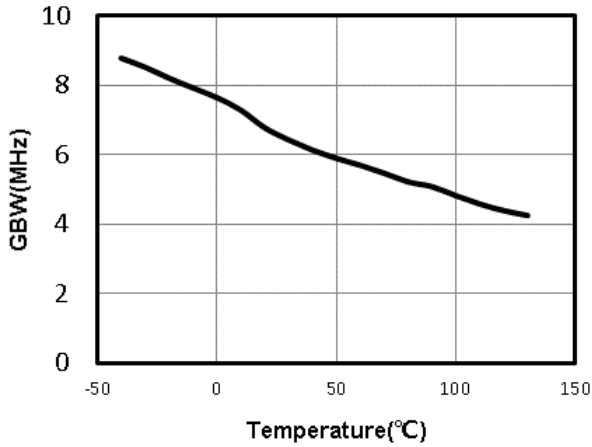

Figure 1. Unity Gain Bandwidth vs. Temperature

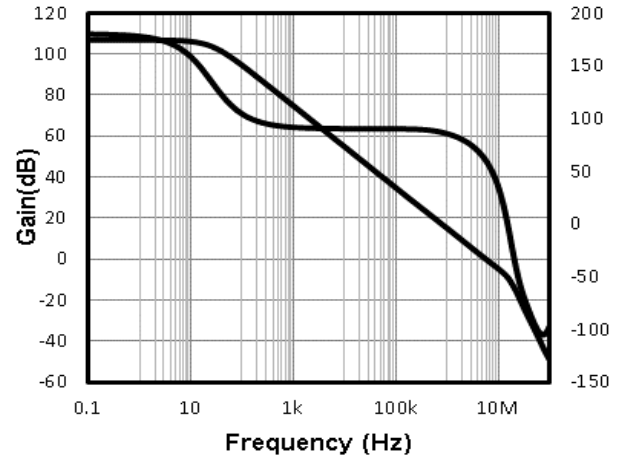

Figure 2. Open-Loop Gain and Phase

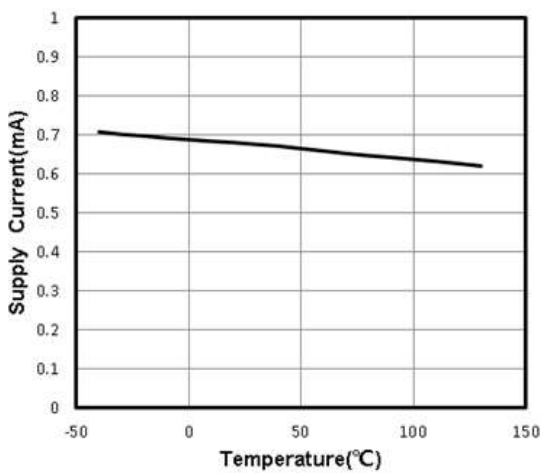

Figure 3. Supply Current vs. Temperature

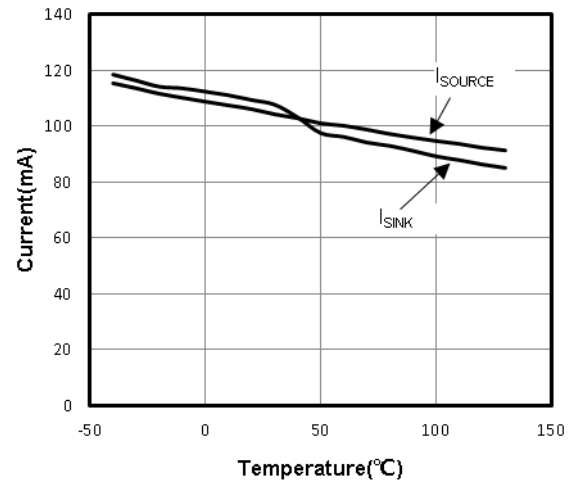

Figure 4. Short Circuit Current vs. Temperature

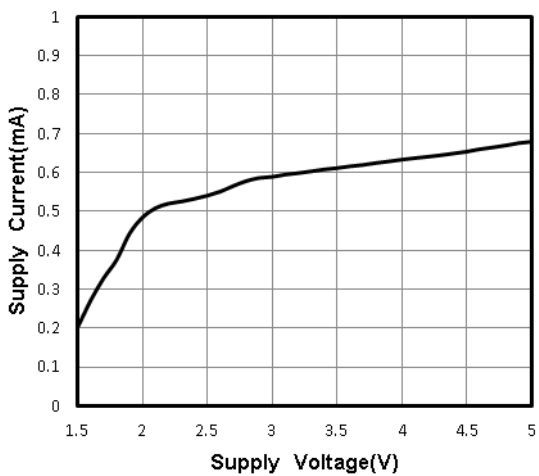

Figure 5. Quiescent Current vs. Supply Voltage

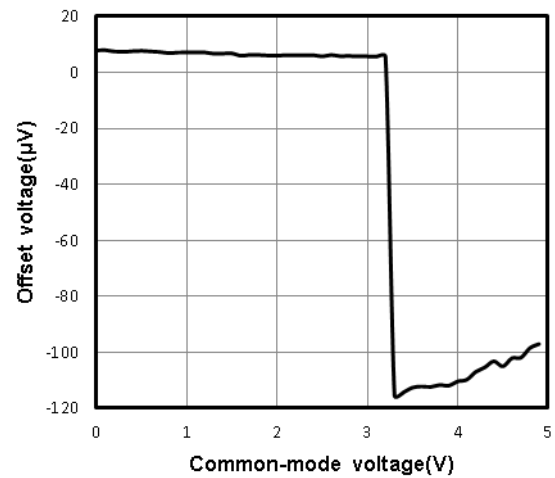

Figure 6. Offset Voltage vs. Common-Mode Voltage

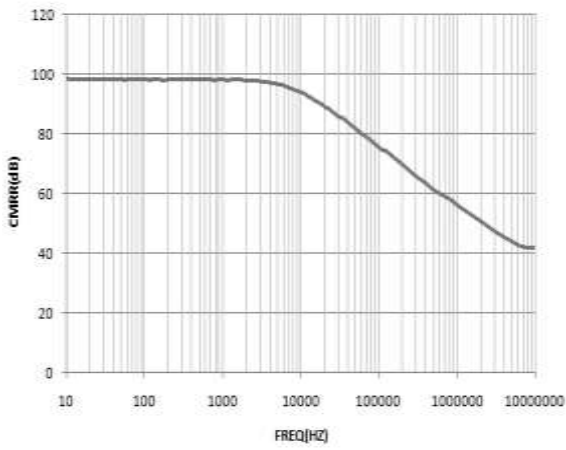

Figure 7. CMRR vs. Frequency

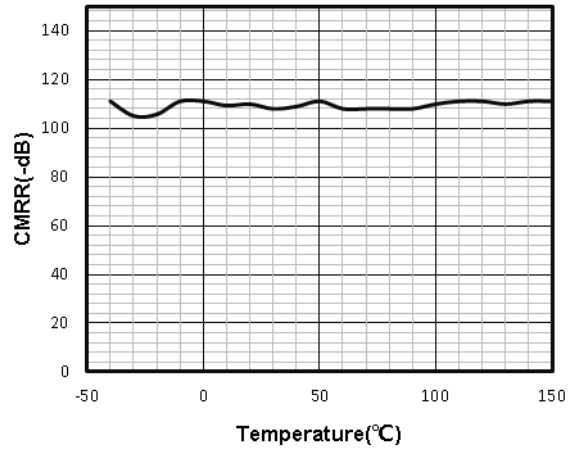

Figure 8. CMRR vs. Temperature

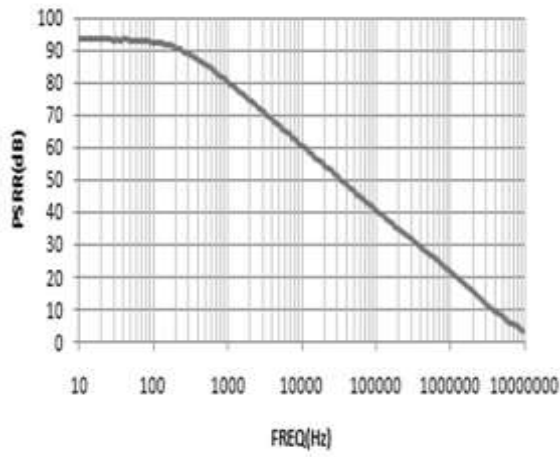

Figure 9. PSRR vs. Frequency

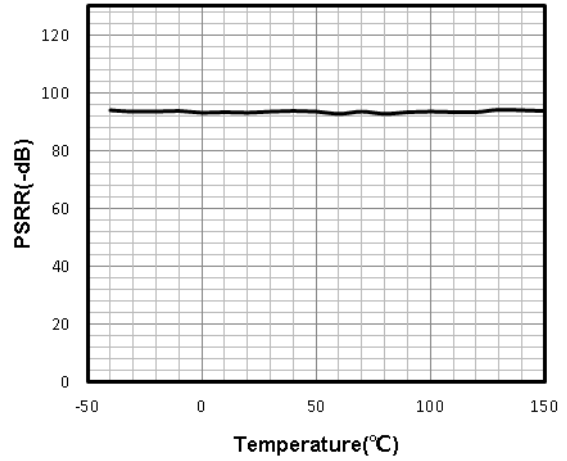

Figure 10. PSRR vs. Temperature

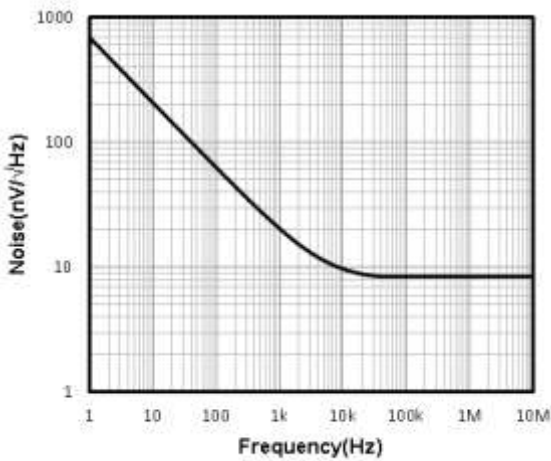

Figure 11. Input Voltage Noise Spectral Density

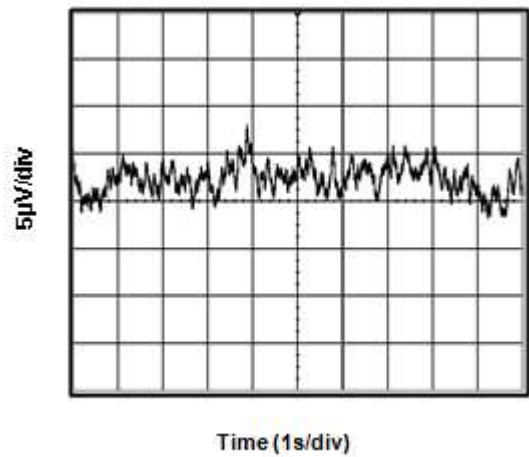

Figure 12. 0.1 Hz to 10 Hz Input Voltage Noise

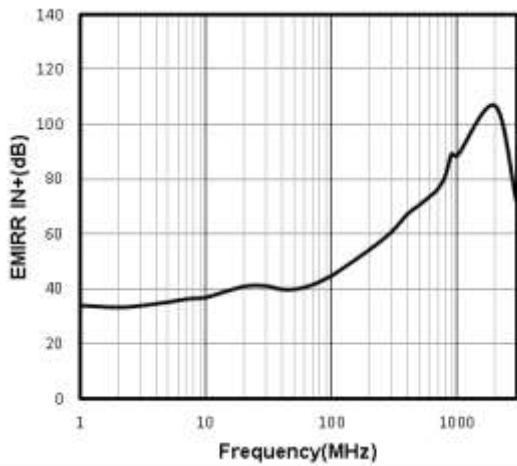
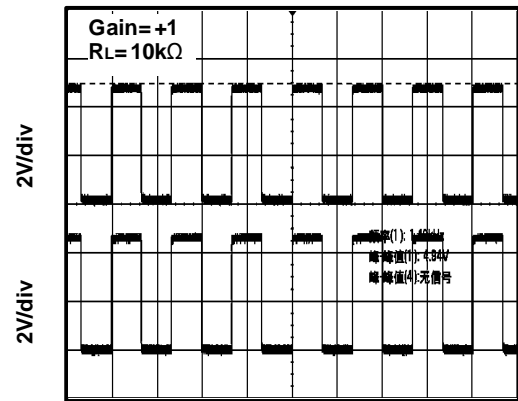
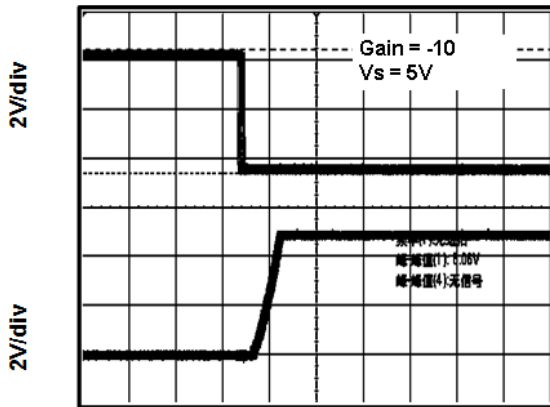

Figure 13. EMIRR IN+ vs. Frequency



Time (500μs/div)

Figure 14. Large-Scale Step Response



Time (2μs/div)

Figure 15. Negative Over-Voltage Recovery

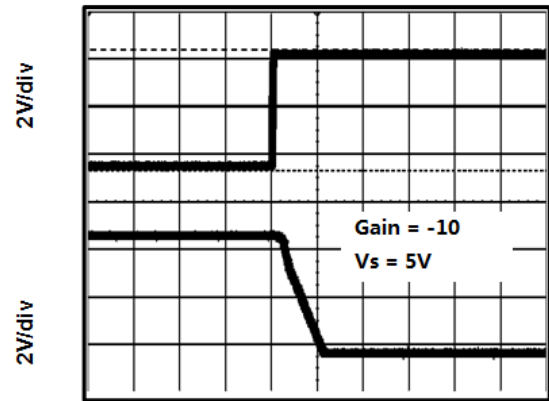

Time (1μs/div)

Figure 16. Positive Over-Voltage Recovery

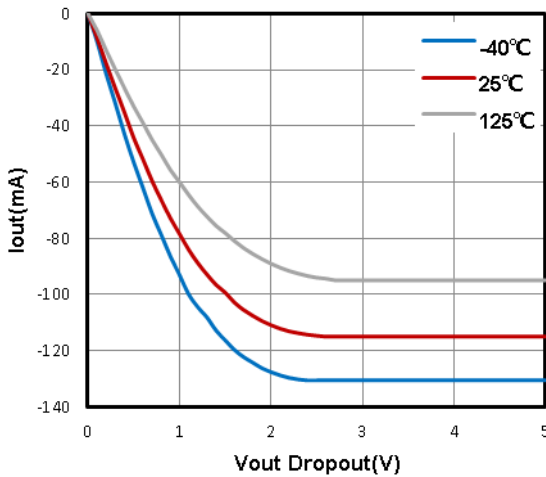

Figure 17. Negative Output Swing vs. Load Current

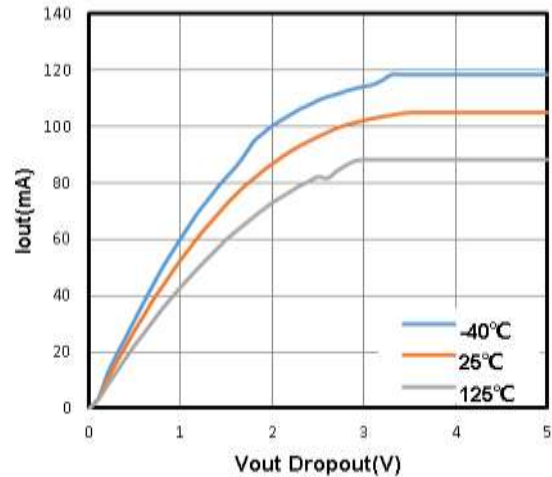
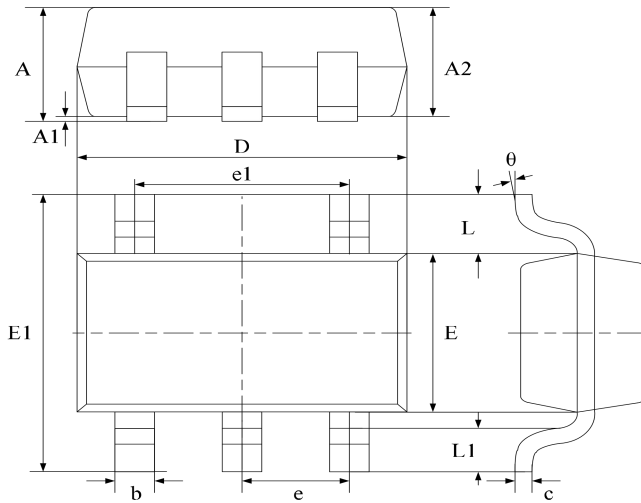

Figure 18. Positive Output Swing vs. Load Current

Package Dimension

SOT23-5



Symbol	Dimensions In Millimeters		Dimensions In Inches	
	Min	Max	Min	Max
A	1.040	1.350	0.042	0.055
A1	0.040	0.150	0.002	0.006
A2	1.000	1.200	0.041	0.049
b	0.380	0.480	0.015	0.020
c	0.110	0.210	0.004	0.009
D	2.720	3.120	0.111	0.127
E	1.400	1.800	0.057	0.073
E1	2.600	3.000	0.106	0.122
e	0.950 typ.		0.037 typ.	
e1	1.900 typ.		0.078 typ.	
L	0.700 ref.		0.028 ref.	
L1	0.300	0.600	0.012	0.024
θ	0°	8°	0°	8°

SOP-14

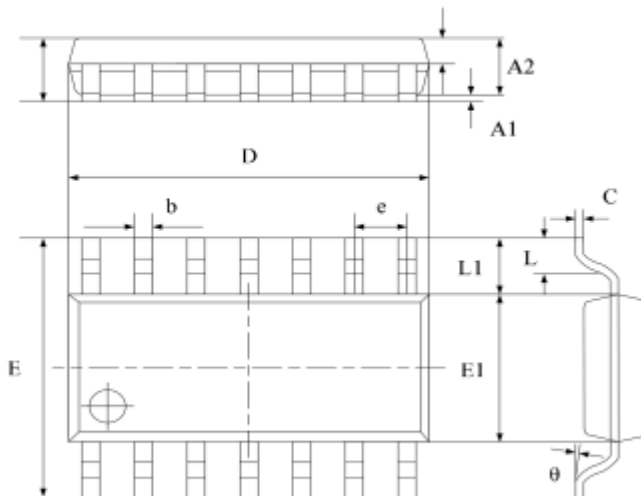

Symbol	Dimensions In Millimeters		Dimensions In Inches	
	Min	Max	Min	Max
A	1.450	1.850	0.059	0.076
A1	0.100	0.300	0.004	0.012
A2	1.350	1.550	0.055	0.063
A3	0.550	0.750	0.022	0.031
b	0.406typ.		0.017typ.	
C	0.203typ.		0.008typ.	
D	8.630	8.830	0.352	0.360
E	5.840	6.240	0.238	0.255
E1	3.850	4.050	0.157	0.165
e	1.270 typ.		0.050 typ.	
L1	1.040 ref.		0.041 ref.	
L	0.350	0.750	0.014	0.031
θ	2°	8°	2°	8°

SOP-8

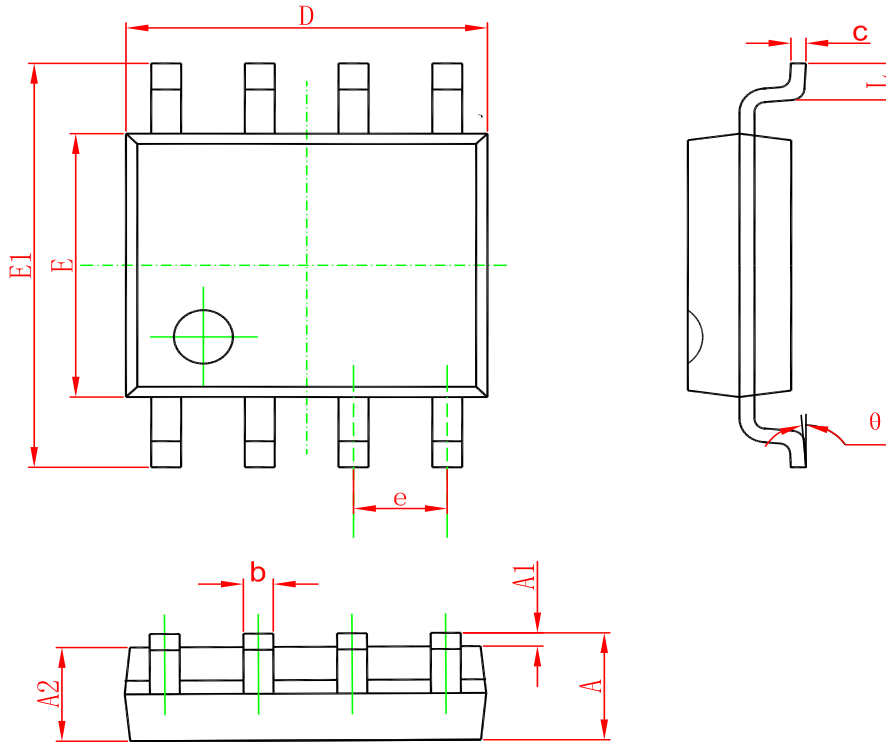

Symbol	Dimensions In Millimeters		Dimensions In Inches	
	Min	Max	Min	Max
A	1.350	1.750	0.053	0.069
A1	0.100	0.250	0.004	0.010
A2	1.350	1.550	0.053	0.061
b	0.330	0.510	0.013	0.020
c	0.170	0.250	0.006	0.010
D	4.700	5.100	0.185	0.200
E	3.800	4.000	0.150	0.157
E1	5.800	6.200	0.228	0.244
e	1.270(BSC)		0.050(BSC)	
L	0.400	1.270	0.016	0.050
θ	0°	8°	0°	8°

Ordering information

Order code	Package	Baseqty	Deliverymode	Marking
UMW TP1562AL1-SR	SOP-8	2500	Tape and reel	1562A
UMW TP1564AL1-SR	SOP-14	2500	Tape and reel	1564A
UMW TP1561A-TR	SOT23-5	3000	Tape and reel	561G P U