

Features

- Ultra low leakage: nA level
- Operating voltage: 5V
- Low clamping voltage
- Complies with following standards:
 - IEC 61000-4-2 (ESD) immunity test
 - Air discharge: $\pm 20\text{kV}$
 - Contact discharge: $\pm 20\text{kV}$
 - IEC61000-4-4 (EFT) 40A (5/50ns)
 - IEC61000-4-5 (Lightning) 3A (8/20 μs)
- RoHS Compliant

Applications

- Cellular Handsets and Accessories
- Notebooks and Handhelds
- Personal Digital Assistants
- Portable Instrumentation
- Digital Cameras
- Peripherals
- Audio Players, Keypads, Side Keys, LCD
- USB 2.0

Mechanical Characteristics

- Package: SOT-143
- Lead Finish: Matte Tin
- Case Material: "Green" Molding Compound.
- Moisture Sensitivity: Level 3 per J-STD-020
- Quantity Per Reel: 3,000 pcs
- Reel Size: 7 inch
- Device Marking: R05

Absolute Maximum Ratings (T_{amb}=25°C unless otherwise specified)

Parameter	Symbol	Value	Unit
Peak Pulse Power (8/20 μs)	P _{pp}	50	W
ESD per IEC 61000-4-2 (Air)	V _{ESD}	± 20	Kv
ESD per IEC 61000-4-2 (Contact)		± 20	
Operating Temperature Range	T _J	-55 to +125	°C
Storage Temperature Range	T _{STJ}	-55 to +150	°C

Dimensions SOT-143

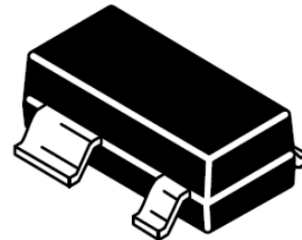

Pin Configuration

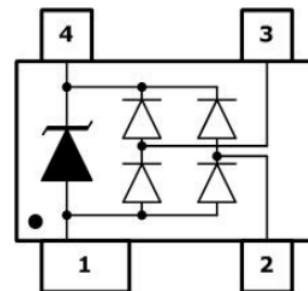

Electrical Characteristics (TA=25°C unless otherwise specified)

Parameter	Symbol	Test Condition	Min	Typ	Max	Unit
Reverse Working Voltage	V _{RWM}				5	V
Breakdown Voltage	V _{BR}	I _T = 1mA	6			V
Reverse Leakage Current	I _R	V _{RWM} = 5V			0.5	μA
Clamping Voltage	V _C	I _{PP} = 1A (8 x 20 μs pulse)			10	V
Clamping Voltage	V _C	I _{PP} = 3A (8 x 20 μs pulse)			17	V
Junction Capacitance	C _J	V _R = 0V, f = 1MHz		0.45		pF

Typical Performance Characteristics ($T_A=25^{\circ}\text{C}$ unless otherwise Specified)

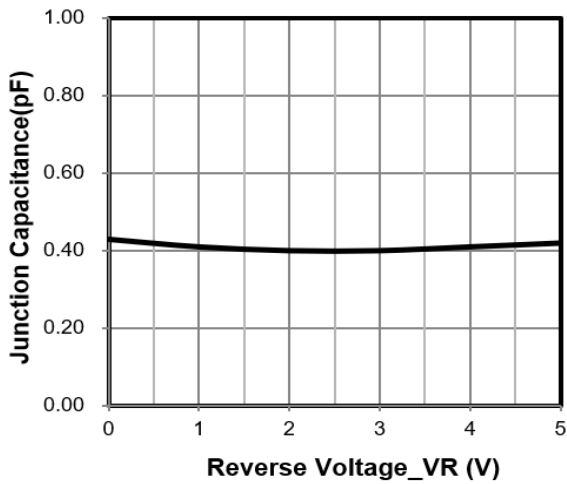

Junction Capacitance vs. Reverse Voltage

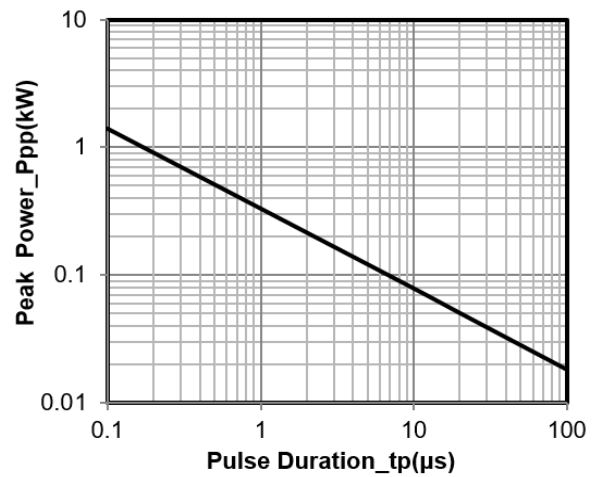

Peak Pulse Power vs. Pulse Time

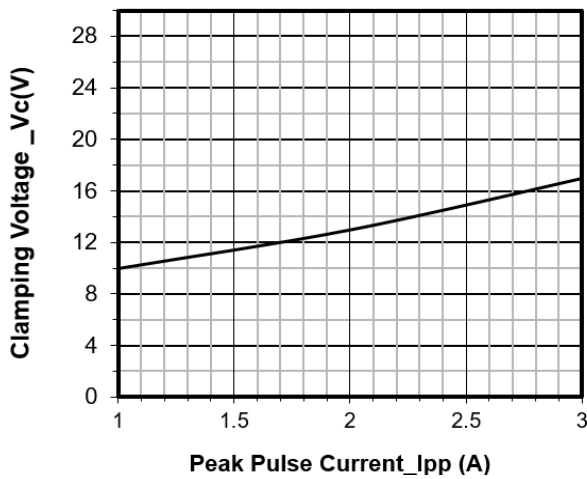

Clamping Voltage vs. Peak Pulse Current

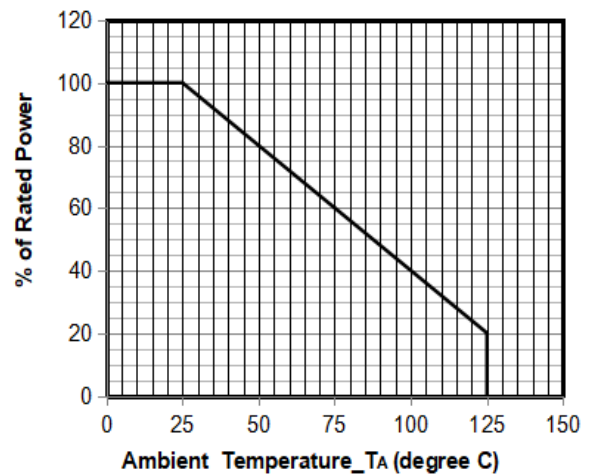

Power Derating Curve

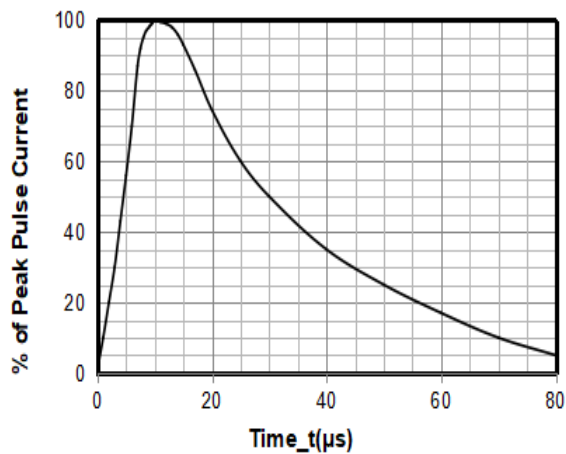

8 X 20μs Pulse Waveform

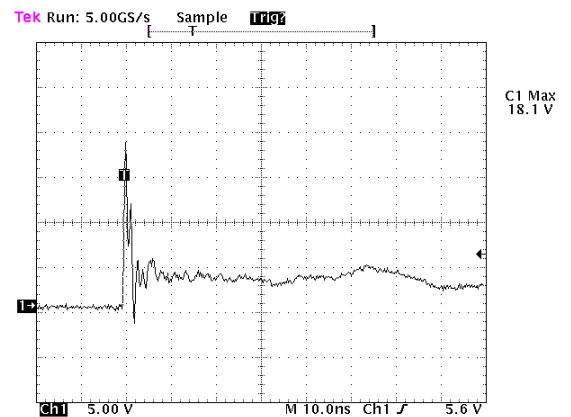

Note: Data is taken with a 10x attenuator

ESD Clamping Voltage

8 kV Contact per IEC61000-4-2

SOT-143 Package Outline & Dimensions

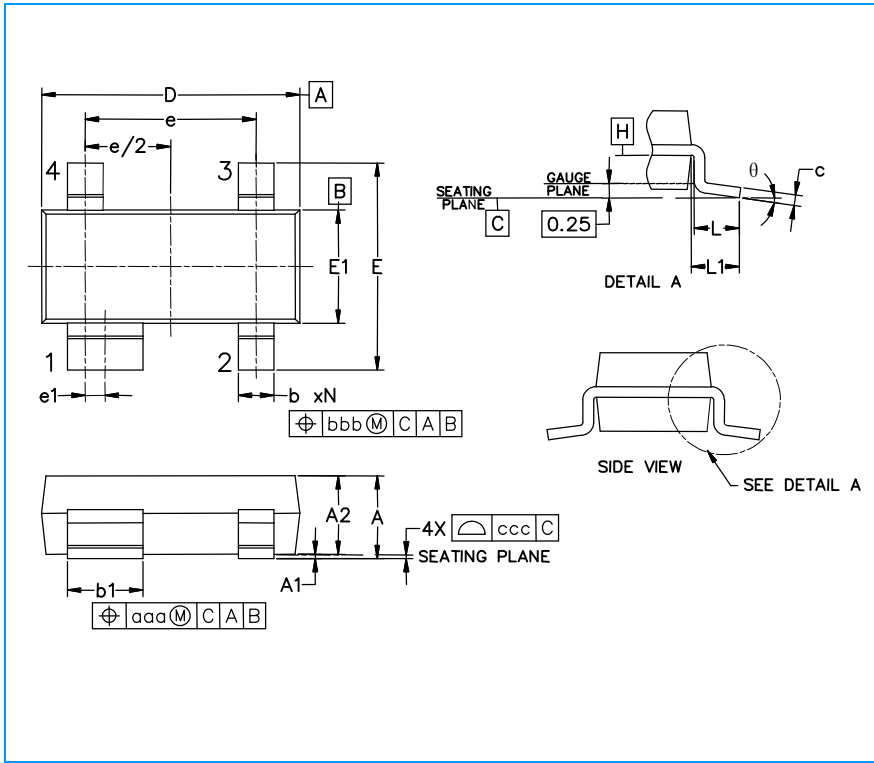

Symbol	Inches			Millimeters		
	Min.	Nom.	Max.	Min.	Nom.	Max.
A	0.031	-	0.048	0.80	-	1.22
A1	0.000	-	0.008	0.013	-	0.15
A2	0.020	0.035	0.042	0.75	0.90	1.07
b	0.011	-	0.020	0.30	-	0.51
b1	0.029	-	0.037	0.76	-	0.94
c	0.003	-	0.008	0.08	-	0.20
D	0.110	0.114	0.120	2.80	2.90	3.04
E	0.082	0.093	0.104	2.10	2.37	2.64
E1	0.047	0.051	0.055	1.20	1.30	1.40
e	0.075		1.92 BSC			
e1	0.008		0.20 BSC			
L	0.015	0.020	0.024	0.40	0.50	0.60
L1	(0.021)		(0.54)			
N	4		4			
theta	0°	-	8°	0°	-	8°
aaa	0.006		0.15			
bbb	0.008		0.20			
ccc	0.004		0.10			

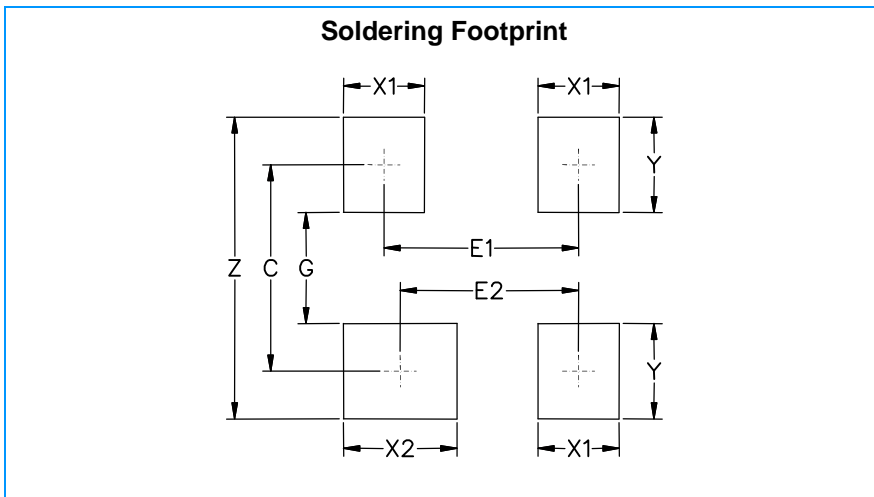

Symbol	Inches	Millimeters
C	(0.087)	(2.20)
E1	0.076	1.92
E2	0.068	1.72
G	0.031	0.80
X1	0.039	1.00
X2	0.047	1.20
Y	0.055	1.40
Z	0.141	3.60