

LM397 Single General-Purpose Voltage Comparator

Features

- TA = 25°C. Typical Values Unless Otherwise Specified.
- 5-Pin SOT-23 Package
- Industrial Operating Range -40°C to +85°C
- Single or Dual Power Supplies
- Wide Supply Voltage Range 5 V to 30 V
- Low Supply Current 300 μ A
- Low Input Bias Current 7 nA
- Low Input Offset Current ± 1 nA
- Low Input Offset Voltage ± 2 mV
- Response Time 440 ns (50-mV Overdrive)
- Input Common-Mode Voltage 0 to $V_S - 1.5$ V



Ordering Information

DEVICE	Package Type	MARKING	Packing	Packing Qty
LM397DBVRG	SOT-23-5	C397	REEL	3000pcs/Reel

Description

The LM397 device is a single voltage comparator with an input common mode that includes ground.

The LM397 is designed to operate from a single 5-V to 30-V power supply or a split power supply. Its low supply current is virtually independent of the magnitude of the supply voltage.

The LM397 features an open-collector output stage.

This allows the connection of an external resistor at the output. The output can directly interface with TTL, CMOS and other logic levels, by tying the resistor to different voltage levels (level translator).

The LM397 is available in the space-saving 5-Pin SOT-23 package and is pin-compatible to TL331, a single differential comparator.

Applications

- A/D Converters
- Pulse, Square-Wave Generators
- Peak Detector
- Industrial Applications

Typical Circuit

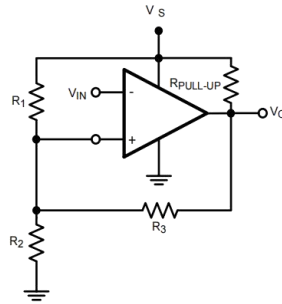

Pin Configuration and Functions

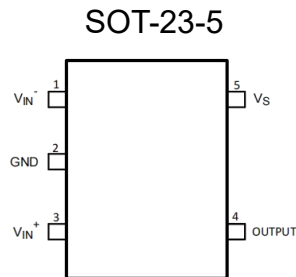

Pin Functions

PIN		TYPE	DESCRIPTION
NAME	NO.		
GND	2	P	Ground
OUTPUT	4	O	Output
V _{IN+}	3	I	Noninverting Input
V _{IN-}	1	I	Inverting Input
V _S	5	P	Supply

Specifications

Absolute Maximum Ratings

over operating free-air temperature range (unless otherwise noted)(1)

		MIN	MAX	UNIT
V _{IN} differential		30	30	V
Supply voltages		±15	30	V
Voltage at input pins		-0.3	30	V
Junction temperature ⁽²⁾			150	°C
Soldering information	Infrared or Convection (20 sec.)		235	°C
	Wave Soldering (10 sec.)		245	°C
Storage Temperature, T _{stg}		-65	150	°C

- Stresses beyond those listed under Absolute Maximum Ratings may cause permanent damage to the device. These are stress ratings only, which do not imply functional operation of the device at these or any other conditions beyond those indicated under Recommended Operating Conditions. Exposure to absolute-maximum-rated conditions for extended periods may affect device reliability.
- The maximum power dissipation is a function of T_{J(MAX)}, R_{θJA}. The maximum allowable power dissipation at any ambient temperature is $P_D = (T_{J(MAX)} - T_A) / R_{\theta JA}$. All numbers apply for packages soldered directly onto a PCB.

ESD Ratings

			VALUE	UNIT
V _(ESD)	Electrostatic discharge	Human body model (HBM), per ANSI/ESDA/JEDEC JS-001 ⁽¹⁾⁽²⁾	±2000	V
		Machine Model ⁽¹⁾⁽²⁾	±200	

- JEDEC document JEP155 states that 500-V HBM allows safe manufacturing with a standard ESD control process.
- Human Body Model, applicable std. MIL-STD-883, Method 3015.7. Machine Model, applicable std. JESD22-A115-A (ESD MM std. of JEDEC) Field-Induced Charge-Device Model, applicable std. JESD22-C101-C (ESD FICDM std. of JEDEC).

Recommended Operating Conditions

		MIN	MAX	UNIT
Supply voltage, V _S		5	30	V
Temperature ⁽¹⁾		-40	85	°C

- The maximum power dissipation is a function of T_{J(MAX)}, R_{θJA}. The maximum allowable power dissipation at any ambient temperature is $P_D = (T_{J(MAX)} - T_A) / R_{\theta JA}$. All numbers apply for packages soldered directly onto a PCB.

Thermal Information

THERMAL METRIC(1)		LM397	UNIT
		DBV (SOT-23)	
		5 PINS	
R θ JA	Junction-to-ambient thermal resistance(2)	186	°C/W
R θ JC(top)	Junction-to-case (top) thermal resistance	92.8	°C/W
R θ JB	Junction-to-board thermal resistance	38.9	°C/W
ψ JT	Junction-to-top characterization parameter	5.6	°C/W
ψ JB	Junction-to-board characterization parameter	38.4	°C/W

- For more information about traditional and new thermal metrics, see the Semiconductor and IC Package Thermal Metrics application report, SPRA953.
- The maximum power dissipation is a function of T_{J(MAX)}, R θ JA. The maximum allowable power dissipation at any ambient temperature is $PD = (T_{J(MAX)} - TA) / R_{\theta JA}$. All numbers apply for packages soldered directly onto a PCB.

Electrical Characteristics

Unless otherwise specified, all limits are ensured for TA = 25°C, VS = 5 V, V- = 0 V, VCM = V+/2 = VO.

PARAMETER	TEST CONDITIONS	MIN(1)	TYP(2)	MAX(1)	UNIT
V _{OS}	VS = 5 V to 30 V, VO = 1.4 V, VCM = 0 V	TA = 25°C	2	7	mV
		At the temperature extremes		10	
I _{OS}	VO = 1.4 V, VCM = 0 V	TA = 25°C	1.6	50	nA
		At the temperature extremes		250	
I _B	VO = 1.4 V, VCM = 0 V	TA = 25°C	10	250	nA
		At the temperature extremes		400	
I _S	RL = open, VS = 5 V		0.25	0.7	mA
	RL = open, VS = 30 V		0.3	2	
I _O	VIN ⁺ = 1 V, VIN ⁻ = 0 V, VO = 1.5 V	6	13		mA
I _{LEAKAGE}	VIN ⁺ = 1 V, VIN ⁻ = 0 V, VO = 5 V		0.1		nA
	VIN ⁺ = 1 V, VIN ⁻ = 0 V, VO = 30 V		1		μA
V _{OL}	IO = -4 mA, VIN ⁺ = 0 V, VIN ⁻ = 1 V	TA = 25°C	180	400	mV
		At the temperature extremes		700	
V _{CM}	VS = 5 V to 30 V(3)	TA = 25°C	0	VS - 1.5	V
		At the temperature extremes	0	VS - 2	
A _V	VS = 15 V, VO = 1.4 V to 11.4 V, RL > = 15 kΩ connected to VS		120		V/mV
t _{PHL}	Input overdrive = 5 mV RL = 5.1 kΩ connected to 5 V, CL = 15 pF		900		ns
	Input overdrive = 50 mV RL = 5.1 kΩ connected to 5 V, CL = 15 pF		250		
t _{PLH}	Input Overdrive = 5 mV RL = 5.1 kΩ connected to 5 V, CL = 15 pF		940		μs
	Input overdrive = 50 mV RL = 5.1 kΩ connected to 5 V, CL = 15 pF		440		

- All limits are specified by testing or statistical analysis.
- Typical values represent the most likely parametric norm as determined at the time of characterization. Actual typical values may vary over time and will also depend on the application and configuration. The typical values are not tested and are not specified on shipped production material.
- The input common-mode voltage of either input should not be permitted to go below the negative rail by more than 0.3V. The upper end of the common-mode voltage range is VS - 1.5 V at 25°C.

Typical Characteristics

$T_A = 25^\circ\text{C}$. Unless otherwise specified.

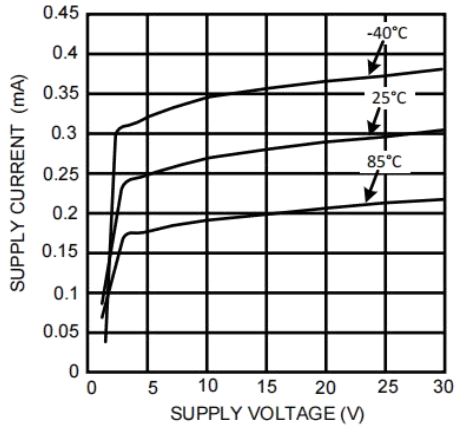

Figure 1. Supply Current vs Supply Voltage

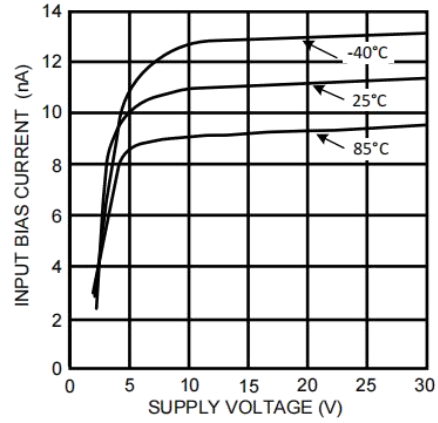

Figure 2. Input Bias Current vs Supply Current

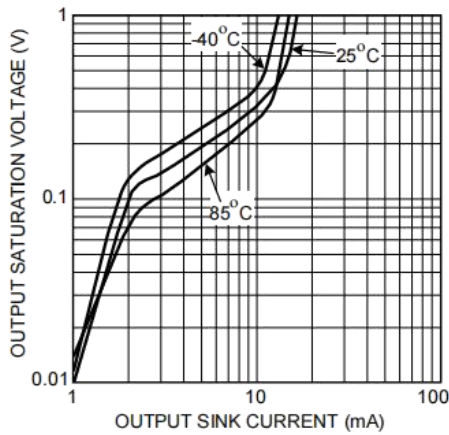

Figure 3. Output Saturation Voltage vs Output Sink Current

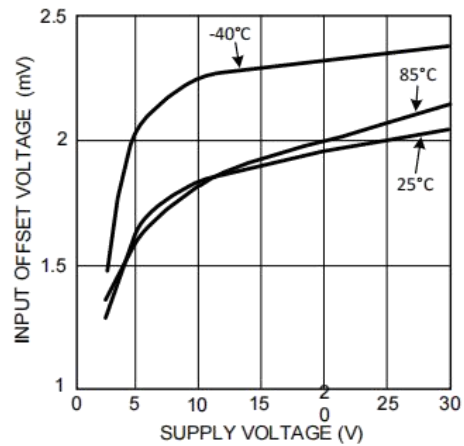

Figure 4. Input Offset Voltage vs Supply Voltage

Detailed Description

Overview

A comparator is often used to convert an analog signal to a digital signal. The comparator compares an input voltage (V_{IN}) at the noninverting pin to the reference voltage (V_{REF}) at the inverting pin. If V_{IN} is less than V_{REF} the output (V_O) is low (V_{OL}). However, if V_{IN} is greater than V_{REF} , the output voltage (V_O) is high (V_{OH}). Refer to Figure 6.

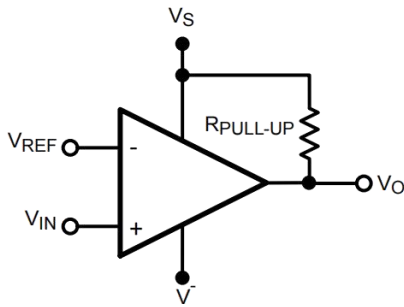

Figure 5. Basic Comparator

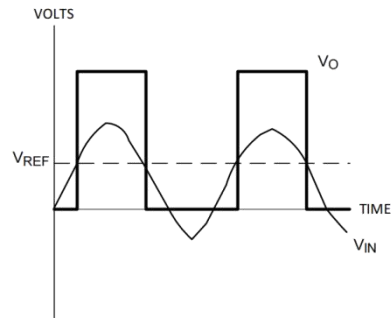
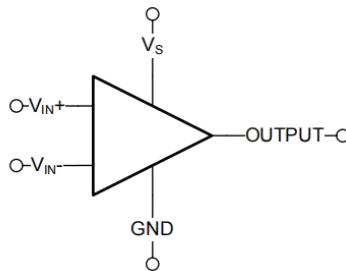

Figure 6. Basic Comparator Output

Functional Block Diagram



Feature Description

Input Stage

The LM397 has a bipolar input stage. The input common-mode voltage range is from 0 to ($V_S - 1.5\text{ V}$).

Output Stage

The LM397 has an open-collector grounded-emitter NPN output transistor for the output stage. This requires an external pullup resistor connected between the positive supply voltage and the output. The external pullup resistor should be high enough resistance so to avoid excessive power dissipation. In addition, the pullup resistor should be low enough resistance to enable the comparator to switch with the load circuitry connected. Because it is an open-collector output stage, several comparator outputs can be connected together to create an OR'ing function output. With an open collector, the output can be used as a simple SPST switch to ground. The amount of current which the output can sink is approximately 10 mA. When the maximum current limit is reached, the output transistor will saturate and the output will rise rapidly (Figure 7)

Feature Description (continued)

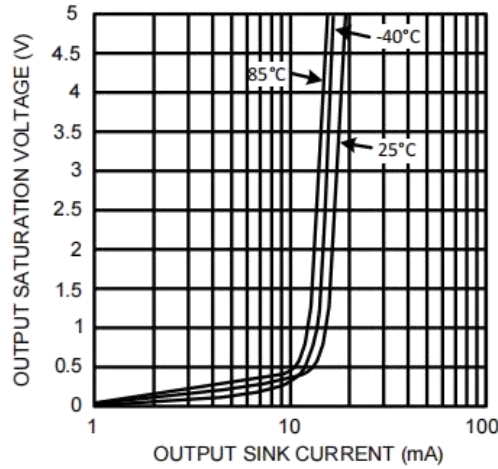

Figure 7. Output Saturation Voltage vs Output Sink Current

Device Functional Modes

Hysteresis

The basic comparator configuration may oscillate or produce a noisy output if the applied differential input is near the input offset voltage of the comparator. This tends to occur when the voltage on the input is equal or very close to the other input voltage. Adding hysteresis can prevent this problem. Hysteresis creates two switching thresholds (one for the rising input voltage and the other for the falling input voltage). Hysteresis is the voltage difference between the two switching thresholds. When both inputs are nearly equal, hysteresis causes one input to effectively move quickly pass the other. Thus, effectively moving the input out of region that oscillation may occur.

For an inverting configured comparator, hysteresis can be added with a three resistor network and positive feedback. When input voltage (V_{IN}) at the inverting node is less than non-inverting node (V_T), the output is high. The equivalent circuit for the three resistor network is R_1 in parallel with R_3 and in series with R_2 . The lower threshold voltage V_{T1} is calculated by Equation 1:

$$V_{T1} = (V_S R_2) / ((R_1 R_3) / (R_1 + R_3) + R_2) \quad (1)$$

When V_{IN} is greater than V_T , the output voltage is low. The equivalent circuit for the three resistor network is R_2 in parallel with R_3 and in series with R_1 . The upper threshold voltage V_{T2} is calculated by Equation 2:

$$V_{T2} = V_S ((R_2 R_3) / (R_2 + R_3)) / (R_1 + ((R_2 R_3) / (R_2 + R_3))) \quad (2)$$

The hysteresis is defined in Equation 3:

$$\Delta V_{IN} = V_{T1} - V_{T2} \quad (3)$$

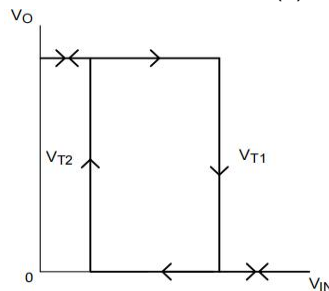

Figure 8. Inverting Configured Comparator - LM397

Application Information

LM397 will typically be used to compare a single signal to a reference or two signals against each other.

Typical Application

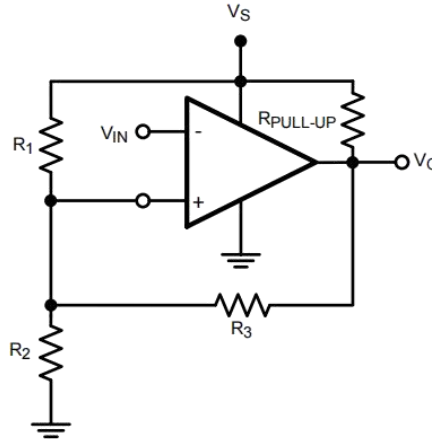

Figure 9. Inverting Comparator With Hysteresis

Design Requirements

For this design example, use the parameters listed in Table 1 as the input parameters.

Table 1. Design Parameters

DESIGN PARAMETER	EXAMPLE VALUE
Input voltage range	0 V to $V_S - 1.5$ V
Supply voltage	5 V to 30 V
Logic supply voltage (R_{PULLUP} voltage)	5 V to 30 V
Output current (V_{LOGIC}/R_{PULLUP})	1 μ A to 20 mA
Input overdrive voltage	100 mV
Reference voltage	5.5 V

Detailed Design Procedure

When using TL331 in a general comparator application, determine the following:

- Input voltage range
- Minimum overdrive voltage
- Output and drive current

Input Voltage Range

When choosing the input voltage range, the input common mode voltage range (VCM) must be taken in to account. If temperature operation is above or below 25°C the VCM can range from 0 V to $V_S - 1.5$ V. This limits the input voltage range to as high as $V_S - 1.5$ V and as low as 0 V. Operation outside of this range can yield incorrect comparisons.

Below is a list of input voltage situation and their outcomes:

1. When both IN^- and IN^+ are both within the common mode range:
 - (a) If IN^- is higher than IN^+ and the offset voltage, the output is low and the output transistor is sinking current
 - (b) If IN^- is lower than IN^+ and the offset voltage, the output is high impedance and the output transistor is not conducting
2. When IN^- is higher than common mode and IN^+ is within common mode, the output is low and the output transistor is sinking current
3. When IN^+ is higher than common mode and IN^- is within common mode, the output is high impedance and the output transistor is not conducting
4. When IN^- and IN^+ are both higher than common mode, the output is low and the output transistor is sinking current

Minimum Overdrive Voltage

Overdrive Voltage is the differential voltage produced between the positive and negative inputs of the comparator over the offset voltage. To make an accurate comparison; the overdrive voltage should be higher than the input offset voltage. Overdrive voltage can also determine the response time of the comparator, with the response time decreasing with increasing overdrive.

Output and Drive Current

Output current is determined by the pullup resistance (R_{PULLUP}) and V_S voltage. The output current will produce a output low voltage (V_{OL}) from the comparator. In which V_{OL} is proportional to the output current. Use [Figure 3](#) to determine V_{OL} based on the output current. The output current can also effect the transient response.

Application Curves

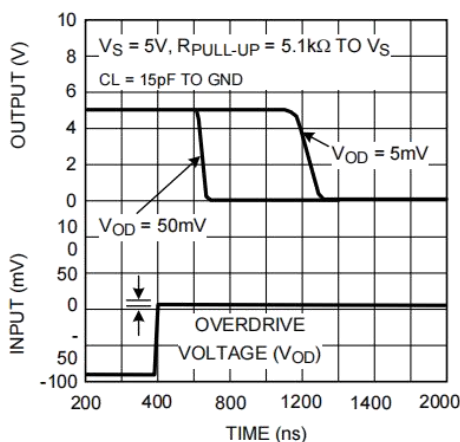

Figure 10. Response Time for Various Input Overdrives-tPHL

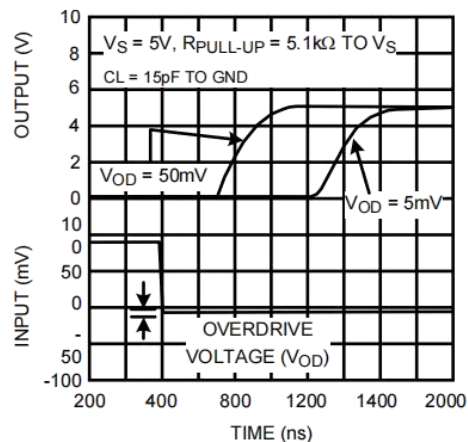
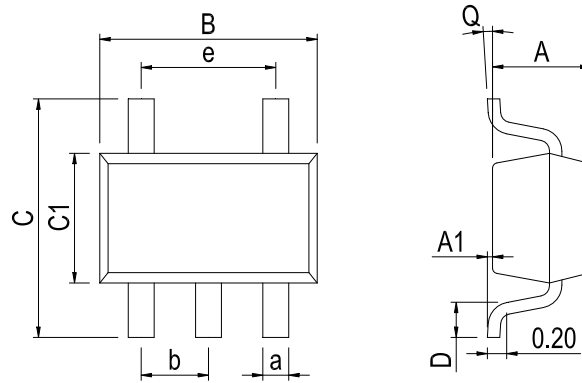

Figure 11. Response Time for Various Input Overdrives-tPLH

Physical Dimensions

SOT-23-5



Dimensions In Millimeters(SOT-23-5)										
Symbol:	A	A1	B	C	C1	D	Q	a	b	e
Min:	1.05	0.00	2.82	2.65	1.50	0.30	0°	0.30	0.95 BSC	1.90 BSC
Max:	1.15	0.15	3.02	2.95	1.70	0.60	8°	0.40		

Revision History

DATE	REVISION	PAGE
2020-8-23	New	1-12
2023-7-24	Update encapsulation type、 Update Lead Temperature	1、 3
2024-3-19	Document reformatting	1

IMPORTANT STATEMENT:

Hanschip Semiconductor reserves the right to change its products and services without notice. Before ordering, the customer shall obtain the latest relevant information and verify whether the information is up to date and complete. Hanschip Semiconductor does not assume any responsibility or obligation for the altered documents.

Customers are responsible for complying with safety standards and taking safety measures when using Hanschip Semiconductor products for system design and machine manufacturing. You will bear all the following responsibilities: select the appropriate Hanschip Semiconductor products for your application; Design, validate and test your application; Ensure that your application meets the appropriate standards and any other safety, security or other requirements. To avoid the occurrence of potential risks that may lead to personal injury or property loss.

Hanschip Semiconductor products have not been approved for applications in life support, military, aerospace and other fields, and Hanschip Semiconductor will not bear the consequences caused by the application of products in these fields. All problems, responsibilities and losses arising from the user's use beyond the applicable area of the product shall be borne by the user and have nothing to do with Hanschip Semiconductor, and the user shall not claim any compensation liability against Hanschip Semiconductor by the terms of this Agreement.

The technical and reliability data (including data sheets), design resources (including reference designs), application or other design suggestions, network tools, safety information and other resources provided for the performance of semiconductor products produced by Hanschip Semiconductor are not guaranteed to be free from defects and no warranty, express or implied, is made. The use of testing and other quality control technologies is limited to the quality assurance scope of Hanschip Semiconductor. Not all parameters of each device need to be tested.

The documentation of Hanschip Semiconductor authorizes you to use these resources only for developing the application of the product described in this document. You have no right to use any other Hanschip Semiconductor intellectual property rights or any third party intellectual property rights. It is strictly forbidden to make other copies or displays of these resources. You should fully compensate Hanschip Semiconductor and its agents for any claims, damages, costs, losses and debts caused by the use of these resources. Hanschip Semiconductor accepts no liability for any loss or damage caused by infringement.