

### 1. Product Description and Identification (Part Number)

- Description  
Example:  
RL series of multi-layer chip NTC thermistors.
- Product Identification (Part Number)

$\frac{RL}{\textcircled{1}}$      $\frac{xxxx}{\textcircled{2}}$      $\frac{N}{\textcircled{3}}$      $\frac{xxx}{\textcircled{4}}$      $\frac{\square}{\textcircled{5}}$      $\frac{xxxx}{\textcircled{6}}$      $\frac{\textcircled{7}}{\textcircled{7}}$      $\frac{T}{\textcircled{8}}$      $\frac{F}{\textcircled{9}}$

| ① Type |                     |
|--------|---------------------|
| RL     | Chip NTC Thermistor |

| ③ Internal Code |  |
|-----------------|--|
| N               |  |

| ⑤ Resistance Tolerance |      |
|------------------------|------|
| F                      | ±1%  |
| H                      | ±3%  |
| J                      | ±5%  |
| K                      | ±10% |

| ⑦ B Constant Tolerance |     |
|------------------------|-----|
| F                      | ±1% |
| H                      | ±3% |

| ⑨ HSF Products                    |  |
|-----------------------------------|--|
| Hazardous Substance Free Products |  |

| ② External Dimensions (L×W) [mm] |          |
|----------------------------------|----------|
| 0201                             | 0.6×0.3  |
| 0402                             | 1.0×0.5  |
| 0603                             | 1.6×0.8  |
| 0805                             | 2.0×1.25 |

| ④ Nominal Zero-Power Resistance (KΩ) |               |
|--------------------------------------|---------------|
| Example                              | Nominal Value |
| 103                                  | 10            |
| 223                                  | 22            |
| 104                                  | 100           |

| ⑥ Nominal B Constant (25°C to 50°C) |         |
|-------------------------------------|---------|
| Example                             | Nominal |
| 3450                                | 3450K   |
| 4250                                | 4250K   |

| ⑧ Packaging |             |
|-------------|-------------|
| T           | Tape & Reel |

### 2. Electrical Characteristics

Please refer to **Appendix A** (Page 8~11).

- Operating and storage temperature range (individual chip without packing): -55°C ~ +125°C
- Storage temperature range (packing conditions): -10°C~+40°C and RH 75% (Max.)

### 3. Shape and Dimensions

- Dimensions: See **Fig.4-1** and **Table 4-1**.
- Recommended PCB pattern for reflow soldering: See **Fig.4-2** and **Table 4-1**.

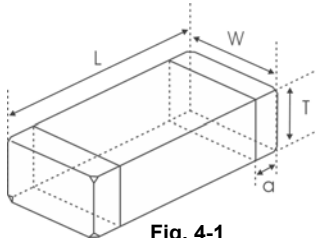

Fig. 4-1

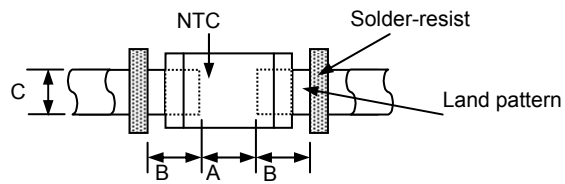

Fig. 4-2

[Table 4-1]

Unit: mm [inch]

| Type   | L                         | W                         | T                         | a                          | A         | B         | C         |
|--------|---------------------------|---------------------------|---------------------------|----------------------------|-----------|-----------|-----------|
| [0201] | 0.6±0.05<br>[0.024±0.002] | 0.3±0.05<br>[0.012±0.002] | 0.3±0.05<br>[0.012±0.002] | 0.15±0.05<br>[0.006±0.002] | 0.20~0.30 | 0.20~0.30 | 0.30~0.35 |
| [0402] | 1.0±0.15<br>[0.039±0.006] | 0.5±0.15<br>[0.020±0.006] | 0.5±0.15<br>[0.020±0.006] | 0.25±0.1<br>[0.010±0.004]  | 0.45~0.55 | 0.40~0.50 | 0.45~0.55 |
| [0603] | 1.6±0.15<br>[0.063±0.006] | 0.8±0.15<br>[0.031±0.006] | 0.8±0.15<br>[0.031±0.006] | 0.3±0.2<br>[0.012±0.008]   | 0.60~0.80 | 0.60~0.80 | 0.60~0.80 |
| [0805] | 2.0±0.2<br>[0.079±0.008]  | 1.25±0.2<br>[0.049±0.008] | 0.85±0.2<br>[0.033±0.008] | 0.5±0.3<br>[0.020±0.012]   | 0.80~1.20 | 0.80~1.20 | 0.90~1.60 |

**5. Test and Measurement Procedures**

**5.1 Test Conditions**

5.1.1 Unless otherwise specified, the standard atmospheric conditions for measurement/test as:

- a. Ambient Temperature: 20±15°C
- b. Relative Humidity : 65±20%
- c. Air Pressure: 86kPa to 106kPa

5.1.2 If any doubt on the results, measurements/tests should be made within the following limits:

- a. Ambient Temperature: 20±2°C
- b. Relative Humidity: 65±5%
- c. Air Pressure: 86kPa to 106kPa

**5.2 Visual Examination**

- a. Inspection Equipment: 20× magnifier

**5.3 Electrical Test**

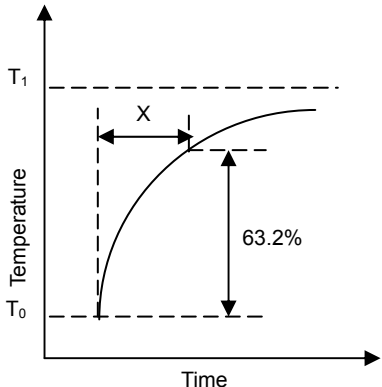
| Items  | Requirements  | Test Methods and Remarks  |
|--|---|---|
| 5.3.1<br>Nominal<br>Zero-Power<br>Resistance (R25) | Refer to <b>Appendix A</b>  | Ambient temperature: 25±0.2°C.<br>Measuring electric power: 0.1mW Max.  |
| 5.3.2<br>Nominal B<br>Constant                     | Refer to <b>Appendix A</b>  | Measure the resistance at the ambient temperature of 25±0.2°C and 50±0.2°C<br><br>$B = \frac{\ln R_{25} - \ln R_{50}}{1/T_{25} - 1/T_{50}}$ T: absolute temperature (K)   |
| 5.3.3<br>Thermal Time<br>Constant<br>(single unit) | Refer to <b>Appendix A</b><br><br> | The total time for the temperature of the thermistor to change by 63.2% of the difference from ambient temperature T <sub>0</sub> (°C) to T <sub>1</sub> (°C) by the drastic change of the power applied to thermistor from Non-zero Power to Zero-Power state. |
| 5.3.4<br>Dissipation<br>Constant<br>(single unit)  | Refer to <b>Appendix A</b>  | The total electric power required to raise the temperature of the element by 1°C through self-heating under thermal equilibrium. It calculates by next formula.<br><br>$C = \frac{W}{T - T_0}$  |
| 5.3.5<br>Rated Power                               | Refer to <b>Appendix A</b>  | The necessary electric power makes thermistor's temperature rise 100°C by self-heating at ambient temperature 25°C.   |
| 5.3.6<br>Permissive<br>operating current           | Refer to <b>Appendix A</b>  | The current that keeps body temperature of chip NTC on the PC board in still air rising 1°C by self-heating.  |

5.4 Reliability Test

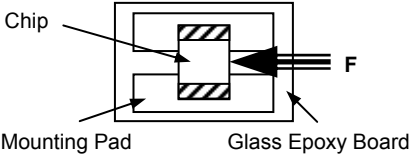
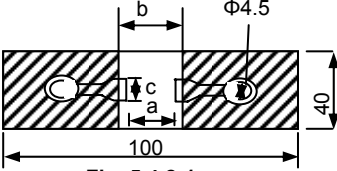
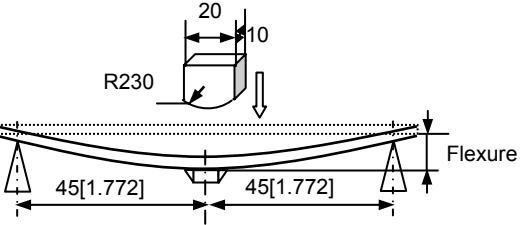
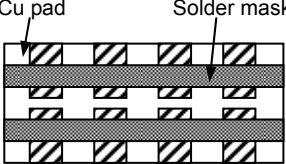
| Items                                 | Requirements   | Test Methods and Remarks   |      |   |   |            |      |     |     |            |     |     |     |            |     |     |     |            |     |     |      |  |
|---------------------------------------|--|--|------|---|---|------------|------|-----|-----|------------|-----|-----|-----|------------|-----|-----|-----|------------|-----|-----|------|--|
| 5.4.1.<br>Terminal Strength           | No removal or split of the termination or other defects shall occur.<br><br> <p style="text-align: center;">Fig.5.4.1-1</p>   | <ol style="list-style-type: none"> <li>① Solder the chip to the testing jig (glass epoxy board shown in the following Fig. 5.4.1-1) using eutectic solder. Then apply a force in the direction of the arrow.</li> <li>② 2N force for 0603 series, 5N force for 1005 and 1608 series, 10N force for 2012 series.</li> <li>③ Keep time: 10±1s.</li> </ol>  |      |   |   |            |      |     |     |            |     |     |     |            |     |     |     |            |     |     |      |  |
| 5.4.2<br>Resistance to Flexure        | No visible mechanical damage.<br><br>Unit: mm [inch] <table border="1" data-bbox="309 703 767 913" style="margin: 10px auto;"> <thead> <tr> <th>Type</th> <th>a</th> <th>b</th> <th>c</th> </tr> </thead> <tbody> <tr> <td>0603[0201]</td> <td>0.25</td> <td>0.8</td> <td>0.3</td> </tr> <tr> <td>1005[0402]</td> <td>0.4</td> <td>1.5</td> <td>0.5</td> </tr> <tr> <td>1608[0603]</td> <td>1.0</td> <td>3.0</td> <td>1.2</td> </tr> <tr> <td>2012[0805]</td> <td>1.2</td> <td>4.0</td> <td>1.65</td> </tr> </tbody> </table>  <p style="text-align: center;">Fig. 5.4.2-1</p> | Type   | a    | b | c | 0603[0201] | 0.25 | 0.8 | 0.3 | 1005[0402] | 0.4 | 1.5 | 0.5 | 1608[0603] | 1.0 | 3.0 | 1.2 | 2012[0805] | 1.2 | 4.0 | 1.65 | <ol style="list-style-type: none"> <li>① Solder the chip to the test jig (glass epoxy board shown in Fig. 5.4.2-1) using a eutectic solder. Then apply a force in the direction shown in Fig. 5.4.2-2.</li> <li>② Flexure: 2mm.</li> <li>③ Pressurizing Speed: 0.5mm/sec.</li> <li>④ Keep time: 30 sec.</li> </ol>  <p style="text-align: center;">Fig. 5.4.2-2</p> |
| Type                                  | a  | b  | c    |   |   |            |      |     |     |            |     |     |     |            |     |     |     |            |     |     |      |  |
| 0603[0201]                            | 0.25   | 0.8  | 0.3  |   |   |            |      |     |     |            |     |     |     |            |     |     |     |            |     |     |      |  |
| 1005[0402]                            | 0.4  | 1.5  | 0.5  |   |   |            |      |     |     |            |     |     |     |            |     |     |     |            |     |     |      |  |
| 1608[0603]                            | 1.0  | 3.0  | 1.2  |   |   |            |      |     |     |            |     |     |     |            |     |     |     |            |     |     |      |  |
| 2012[0805]                            | 1.2  | 4.0  | 1.65 |   |   |            |      |     |     |            |     |     |     |            |     |     |     |            |     |     |      |  |
| 5.4.3<br>Vibration                    | No visible mechanical damage.<br><br> <p style="text-align: center;">Glass Epoxy Board<br/>Fig. 5.4.3-1</p>   | <ol style="list-style-type: none"> <li>① Solder the chip to the testing jig (glass epoxy board shown in Fig. 5.4.3-1) using eutectic solder.</li> <li>② The chip shall be subjected to a simple harmonic motion having total amplitude of 1.5mm, the frequency being varied uniformly between the approximate limits of 10 and 55 Hz.</li> <li>③ The frequency ranging from 10 to 55 Hz and returning to 10 Hz shall be traversed in approximately 1 minute. This motion shall be applied for a period of 2 hours in each 3 mutually perpendicular directions (total of 6 hours).</li> </ol> |      |   |   |            |      |     |     |            |     |     |     |            |     |     |     |            |     |     |      |  |
| 5.4.4<br>Dropping                     | <ol style="list-style-type: none"> <li>① No visible mechanical damage.</li> </ol>  | Drop chip inductor 10 times on a concrete floor from a height of 100 cm.   |      |   |   |            |      |     |     |            |     |     |     |            |     |     |     |            |     |     |      |  |
| 5.4.5<br>Solderability                | <ol style="list-style-type: none"> <li>① No visible mechanical damage.</li> <li>② Wetting shall exceed 80% coverage.</li> </ol>  | <ol style="list-style-type: none"> <li>① Solder temperature: 240±2℃.</li> <li>② Duration: 3 sec.</li> <li>③ Solder: Sn/3.0Ag/0.5Cu.</li> <li>④ Flux: 25% Resin and 75% ethanol in weight.</li> </ol>   |      |   |   |            |      |     |     |            |     |     |     |            |     |     |     |            |     |     |      |  |
| 5.4.6<br>Resistance to Soldering Heat | <ol style="list-style-type: none"> <li>① No visible mechanical damage.</li> <li>② R25 change: within ±5%.<sup>*1</sup></li> <li>③ B Constant change: within ±2%.<sup>*2</sup></li> </ol>   | <ol style="list-style-type: none"> <li>① Solder temperature: 260±3℃</li> <li>② Duration: 5 sec.</li> <li>③ Solder: Sn/3.0Ag/0.5Cu.</li> <li>④ Flux: 25% Resin and 75% ethanol in weight.</li> <li>⑤ The chip shall be stabilized at normal condition for 1~2 hours before measuring.</li> </ol>  |      |   |   |            |      |     |     |            |     |     |     |            |     |     |     |            |     |     |      |  |

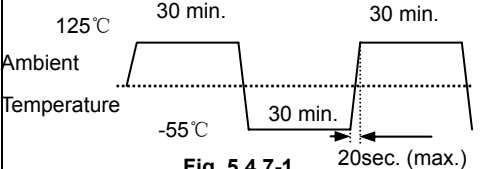
|   |  |   |
|---|--|---|
| <p>5.4.7<br/>Thermal Shock</p>                            | <p>① No visible mechanical damage.<br/>② R25 change: within <math>\pm 5\%</math>.<sup>*1</sup><br/>③ B Constant change: within <math>\pm 2\%</math>.<sup>*2</sup></p>  <p style="text-align: center;"><b>Fig. 5.4.7-1</b></p> | <p>① Temperature, Time: <math>-55^{\circ}\text{C}</math> for <math>30\pm 3</math> min <math>\rightarrow</math> <math>125^{\circ}\text{C}</math> for <math>30\pm 3</math> min.<br/>② Transforming interval: 20sec. Max.<br/>③ Tested cycle: 100 cycles.<br/>④ The chip shall be stabilized at normal condition for 1~2 hours before measuring.</p> |
| <p>5.4.8<br/>Resistance to Low Temperature</p>            | <p>① No visible mechanical damage.<br/>② R25 change: within <math>\pm 5\%</math>.<sup>*1</sup><br/>③ B Constant change: within <math>\pm 2\%</math>.<sup>*2</sup></p>  | <p>① Temperature: <math>-55\pm 2^{\circ}\text{C}</math><br/>② Duration: <math>1000^{+24}</math> hours.<br/>③ The chip shall be stabilized at normal condition for 1~2 hours before measuring.</p>   |
| <p>5.4.9<br/>Resistance to High Temperature</p>           | <p>① No visible mechanical damage.<br/>② R25 change: within <math>\pm 5\%</math>.<sup>*1</sup><br/>③ B Constant change: within <math>\pm 2\%</math>.<sup>*2</sup></p>  | <p>① Temperature: <math>125\pm 2^{\circ}\text{C}</math><br/>② Duration: <math>1000^{+24}</math> hours.<br/>③ The chip shall be stabilized at normal condition for 1~2 hours before measuring.</p>   |
| <p>5.4.10<br/>Damp Heat (Steady States)</p>               | <p>① No visible mechanical damage.<br/>② R25 change: within <math>\pm 5\%</math>.<sup>*1</sup><br/>③ B Constant change: within <math>\pm 2\%</math>.<sup>*2</sup></p>  | <p>① Temperature: <math>60\pm 2^{\circ}\text{C}</math><br/>② Humidity: 90% to 95% RH.<br/>③ Duration: <math>1000^{+24}</math> hours.<br/>④ The chip shall be stabilized at normal condition for 1~2 hours before measuring.</p>   |
| <p>5.4.11<br/>Loading at High Temperature (Life Test)</p> | <p>① No visible mechanical damage.<br/>② R25 change: Within <math>\pm 5\%</math>.<sup>*1</sup><br/>③ B constant change: Within <math>\pm 2\%</math>.<sup>*2</sup></p>  | <p>① Temperature: <math>85\pm 2^{\circ}\text{C}</math><br/>② Duration: <math>1000^{+24}</math> hours.<br/>③ Applied current: Max. Permissible Operating Current.<br/>④ The chip shall be stabilized at normal condition for 1~2 hours before measuring.</p>   |

\*1: For F and H tolerance code, the change of R25 should be within  $\pm 1\%$  and  $\pm 3\%$  respectively. For others, the change of R25 should be within  $\pm 5\%$ .

\*2: For F code tolerance, the change of B constant should be within  $\pm 1\%$ . For others, the change of B constant should be within  $\pm 2\%$ .

## 6. Packaging, Storage and Transportation

### 6.1 Packaging

#### 6.1.1 Tape Carrier Packaging:

Packaging code: T

- a. Tape carrier packaging are specified in attached figure **Fig.6.1-1~4**
- b. Tape carrier packaging quantity please see the following table:

| Type     | 0603[0201]     | 1005[0402]     | 1608[0603]     | 2012[0805]     |
|----------|----------------|----------------|----------------|----------------|
| T(mm)    | 0.3 $\pm$ 0.05 | 0.5 $\pm$ 0.15 | 0.8 $\pm$ 0.15 | 0.85 $\pm$ 0.2 |
| Tape     | Paper Tape     | Paper Tape     | Paper Tape     | Paper Tape     |
| Quantity | 15K            | 10K            | 4K             | 4K             |

(1). Taping Drawings (Unit: mm)

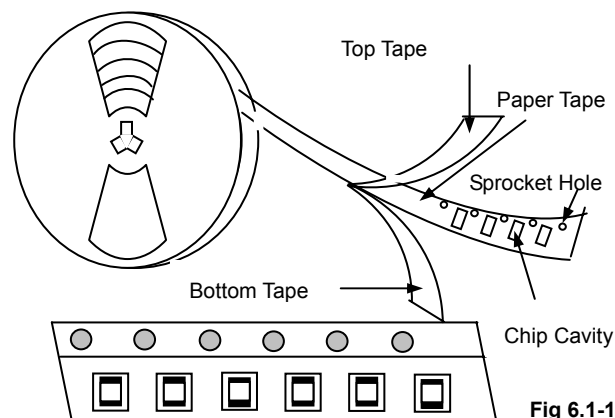

**Remark:** The sprocket holes are to the right as the tape is pulled toward the user.

(2) Taping Dimensions (Unit: mm)

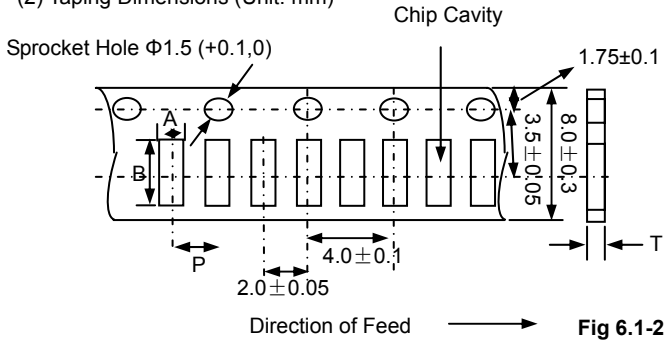

| Type       | A        | B        | P        | Tmax |
|------------|----------|----------|----------|------|
| 0603[0201] | 0.40±0.1 | 0.70±0.1 | 2.0±0.05 | 0.55 |
| 1005[0402] | 0.65±0.1 | 1.15±0.1 | 2.0±0.05 | 0.8  |

Fig 6.1-2

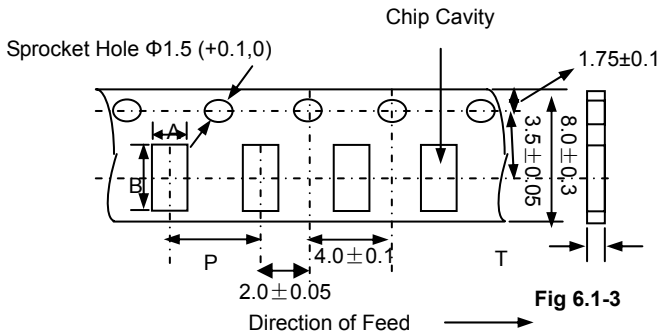

| Type       | A       | B       | P       | Tmax |
|------------|---------|---------|---------|------|
| 1608[0603] | 1.0±0.2 | 1.8±0.2 | 4.0±0.1 | 1.1  |
| 2012[0805] | 1.5±0.2 | 2.3±0.2 | 4.0±0.1 | 1.1  |

Fig 6.1-3

(3) Reel Dimensions (Unit: mm)

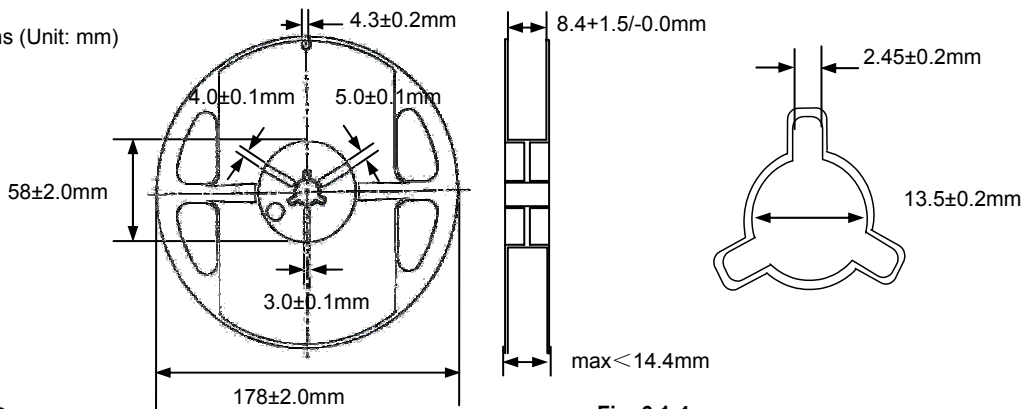

Fig. 6.1-4

6.2 Storage

- The solderability of the external electrode may be deteriorated if packages are stored where they are exposed to high humidity. Package must be stored at 40°C or less and 70% RH or less.
- The solderability of the external electrode may be deteriorated if packages are stored where they are exposed to dust of harmful gas (e.g. HCl, sulfurous gas of H<sub>2</sub>S)
- Packaging material may be deform-ed if package are stored where they are exposed to heat of direct sunlight.
- Solderability specified in **Clause 5.4.6** shall be guaranteed for 3 months from the date of delivery on condition that they are stored at the environment specified in **Clause 3** .For those parts, which passed more than 3 months shall be checked solder-ability before use.

7. Recommended Soldering Technologies

7.1 Re-flowing Profile:

- △ Preheat condition: 150 ~200°C/60~120sec.
- △ Allowed time above 217°C: 60~90sec.
- △ Max temp: 260°C
- △ Max time at max temp: 10sec.
- △ Solder paste: Sn/3.0Ag/0.5Cu
- △ Allowed Reflow time: 2x max

[Note: The reflow profile in the above table is only for qualification and is not meant to specify board assembly profiles. Actual board assembly profiles must be based on the customer's specific board design, solder paste and process, and should not exceed the parameters as the Reflow profile shows.]

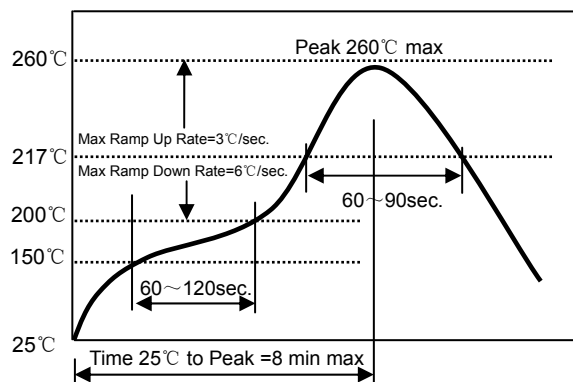

**7.2 Iron Soldering Profile.**

- △ Iron soldering power: Max.30W
- △ Pre-heating: 150 °C / 60 sec.
- △ Soldering Tip temperature: 350°CMax.
- △ Soldering time: 3 sec Max.
- △ Solder paste: Sn/3.0Ag/0.5Cu
- △ Max.1 times for iron soldering

[Note: Take care not to apply the tip of the soldering iron to the terminal electrodes.]

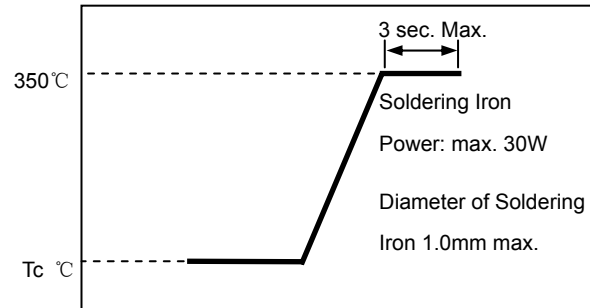

**I. RL0201 Series**

| Part Number        | Resistance at 25°C<br>R25 (kΩ) | B constant<br>(25-50°C) (K) | Max. Permissive<br>Operating<br>Current (25°C)<br>(mA) | Thermal Time<br>Constant | Dissipation<br>Factor (mW/°C) | Rated Electric<br>Power (mW) |
|--------------------|--------------------------------|-----------------------------|--|--------------------------|-------------------------------|------------------------------|
| RL0201N103□3380◎TF | 10                             | 3380                        | 0.31   | <3sec                    | 1.0                           | 100                          |
| RL0201N683□4150◎TF | 68                             | 4150                        | 0.11   |                          |                               |                              |
| RL0201N104□4150◎TF | 100                            | 4150                        | 0.10   |                          |                               |                              |

**II. RL0402 Series**

| Part Number        | Resistance at 25°C<br>R25 (kΩ) | B constant<br>(25-50°C) (K) | Max. Permissive<br>Operating<br>Current (25°C)<br>(mA) | Thermal Time<br>Constant | Dissipation<br>Factor (mW/°C) | Rated Electric<br>Power (mW) |
|--------------------|--------------------------------|-----------------------------|--|--------------------------|-------------------------------|------------------------------|
| RL0402N220□3380◎TF | 0.022                          | 3380                        | 6.7  | <3sec                    | 1.0                           | 100                          |
| RL0402N400□3380◎TF | 0.040                          | 3380                        | 5.0  |                          |                               |                              |
| RL0402N101□3380◎TF | 0.10                           | 3380                        | 3.1  |                          |                               |                              |
| RL0402N151□3380◎TF | 0.15                           | 3380                        | 2.5  |                          |                               |                              |
| RL0402N221□3450◎TF | 0.22                           | 3450                        | 2.1  |                          |                               |                              |
| RL0402N331□3450◎TF | 0.33                           | 3450                        | 1.7  |                          |                               |                              |
| RL0402N471□3450◎TF | 0.47                           | 3450                        | 1.4  |                          |                               |                              |
| RL0402N681□3450◎TF | 0.68                           | 3450                        | 1.2  |                          |                               |                              |
| RL0402N102□3450◎TF | 1.0                            | 3450                        | 1.0  |                          |                               |                              |
| RL0402N152□3950◎TF | 1.5                            | 3950                        | 0.81   |                          |                               |                              |
| RL0402N222□3950◎TF | 2.2                            | 3950                        | 0.67   |                          |                               |                              |
| RL0402N332□3950◎TF | 3.3                            | 3950                        | 0.55   |                          |                               |                              |
| RL0402N472□3950◎TF | 4.7                            | 3950                        | 0.46   |                          |                               |                              |
| RL0402N682□3950◎TF | 6.8                            | 3950                        | 0.38   |                          |                               |                              |
| RL0402N103□3380◎TF | 10                             | 3380                        | 0.31   |                          |                               |                              |
| RL0402N103□3950◎TF | 10                             | 3950                        | 0.33   |                          |                               |                              |
| RL0402N103□4050◎TF | 10                             | 4050                        | 0.33   |                          |                               |                              |
| RL0402N153□3450◎TF | 15                             | 3450                        | 0.25   |                          |                               |                              |
| RL0402N223□3950◎TF | 22                             | 3950                        | 0.23   |                          |                               |                              |
| RL0402N333□3500◎TF | 33                             | 3500                        | 0.14   |                          |                               |                              |
| RL0402N473□4100◎TF | 47                             | 4100                        | 0.12   |                          |                               |                              |
| RL0402N503□4100◎TF | 50                             | 4100                        | 0.12   |                          |                               |                              |
| RL0402N683□4150◎TF | 68                             | 4150                        | 0.11   |                          |                               |                              |
| RL0402N104□4150◎TF | 100                            | 4150                        | 0.10   |                          |                               |                              |
| RL0402N104□4250◎TF | 100                            | 4250                        | 0.10   |                          |                               |                              |
| RL0402N154□4150◎TF | 150                            | 4150                        | 0.08   |                          |                               |                              |
| RL0402N224□4250◎TF | 220                            | 4250                        | 0.06   |                          |                               |                              |
| RL0402N334□4300◎TF | 330                            | 4300                        | 0.05   |                          |                               |                              |
| RL0402N474□4350◎TF | 470                            | 4350                        | 0.04   |                          |                               |                              |
| RL0402N684□4400◎TF | 680                            | 4400                        | 0.03   |                          |                               |                              |

**III. RL0603 Series**

| Part Number         | Resistance at 25°C<br>R25 (kΩ) | B constant<br>(25-50°C) (K) | Max. Permissible<br>Operating<br>Current (25°C)<br>(mA) | Thermal Time<br>Constant | Dissipation<br>Factor<br>(mW/°C) | Rated Electric<br>Power (mW) |
|---------------------|--------------------------------|-----------------------------|---|--------------------------|----------------------------------|------------------------------|
| RL0603N101 □3380◎TF | 0.10                           | 3380                        | 3.1   | <5sec                    | 1.0                              | 100                          |
| RL0603N151 □3380◎TF | 0.15                           | 3380                        | 2.5   |                          |                                  |                              |
| RL0603N221 □3450◎TF | 0.22                           | 3450                        | 2.1   |                          |                                  |                              |
| RL0603N331 □3450◎TF | 0.33                           | 3450                        | 1.7   |                          |                                  |                              |
| RL0603N471 □3450◎TF | 0.47                           | 3450                        | 1.4   |                          |                                  |                              |
| RL0603N681 □3450◎TF | 0.68                           | 3450                        | 1.2   |                          |                                  |                              |
| RL0603N102 □3450◎TF | 1.0                            | 3450                        | 1.0   |                          |                                  |                              |
| RL0603N152 □3450◎TF | 1.5                            | 3450                        | 0.81  |                          |                                  |                              |
| RL0603N222 □3950◎TF | 2.2                            | 3950                        | 0.67  |                          |                                  |                              |
| RL0603N302 □3950◎TF | 3.0                            | 3950                        | 0.55  |                          |                                  |                              |
| RL0603N332 □3950◎TF | 3.3                            | 3950                        | 0.55  |                          |                                  |                              |
| RL0603N472 □3500◎TF | 4.7                            | 3500                        | 0.44  |                          |                                  |                              |
| RL0603N472 □3950◎TF | 4.7                            | 3950                        | 0.46  |                          |                                  |                              |
| RL0603N502 □3950◎TF | 5.0                            | 3950                        | 0.44  |                          |                                  |                              |
| RL0603N682 □3950◎TF | 6.8                            | 3950                        | 0.38  |                          |                                  |                              |
| RL0603N103 □3450◎TF | 10                             | 3450                        | 0.31  |                          |                                  |                              |
| RL0603N103 □3950◎TF | 10                             | 3950                        | 0.33  |                          |                                  |                              |
| RL0603N153 □3950◎TF | 15                             | 3950                        | 0.25  |                          |                                  |                              |
| RL0603N223 □4050◎TF | 22                             | 4050                        | 0.21  |                          |                                  |                              |
| RL0603N333 □4050◎TF | 33                             | 4050                        | 0.17  |                          |                                  |                              |
| RL0603N473 □4050◎TF | 47                             | 4050                        | 0.14  |                          |                                  |                              |
| RL0603N473 □4150◎TF | 47                             | 4150                        | 0.14  |                          |                                  |                              |
| RL0603N503 □4150◎TF | 50                             | 4150                        | 0.13  |                          |                                  |                              |
| RL0603N683 □4150◎TF | 68                             | 4150                        | 0.12  |                          |                                  |                              |
| RL0603N104 □4250◎TF | 100                            | 4250                        | 0.10  |                          |                                  |                              |
| RL0603N154 □4300◎TF | 150                            | 4300                        | 0.08  |                          |                                  |                              |
| RL0603N224 □4350◎TF | 220                            | 4350                        | 0.06  |                          |                                  |                              |
| RL0603N334 □4400◎TF | 330                            | 4400                        | 0.05  |                          |                                  |                              |
| RL0603N474 □4500◎TF | 470                            | 4500                        | 0.04  |                          |                                  |                              |
| RL0603N684 □4500◎TF | 680                            | 4500                        | 0.03  |                          |                                  |                              |
| RL0603N135 □4700◎TF | 1300                           | 4700                        | 0.02  |                          |                                  |                              |

**VI. RL0805 Series**

| Part Number         | Resistance at 25°C<br>R25 (kΩ) | B constant<br>(25-50°C) (K) | Max. Permissible<br>Operating<br>Current (25°C)<br>(mA) | Thermal Time<br>Constant | Dissipation<br>Factor<br>(mW/°C) | Rated Electric<br>Power (mW) |
|---------------------|--------------------------------|-----------------------------|---|--------------------------|----------------------------------|------------------------------|
| RL0805N101 □3380◎TF | 0.10                           | 3380                        | 4.0   | <5sec                    | 2.0                              | 200                          |
| RL0805N151 □3380◎TF | 0.15                           | 3380                        | 3.5   |                          |                                  |                              |
| RL0805N221 □3450◎TF | 0.22                           | 3450                        | 3.0   |                          |                                  |                              |
| RL0805N331 □3450◎TF | 0.33                           | 3450                        | 2.5   |                          |                                  |                              |
| RL0805N471 □3450◎TF | 0.47                           | 3450                        | 2.0   |                          |                                  |                              |
| RL0805N681 □3450◎TF | 0.68                           | 3450                        | 1.7   |                          |                                  |                              |
| RL0805N102 □3450◎TF | 1.0                            | 3450                        | 1.4   |                          |                                  |                              |



| Part Number         | Resistance at 25°C<br>R25 (kΩ) | B constant<br>(25-50°C) (K) | Max. Permissible<br>Operating<br>Current (25°C)<br>(mA) | Thermal Time<br>Constant | Dissipation<br>Factor<br>(mW/°C) | Rated<br>Electric<br>Power<br>(mW) |
|---------------------|--------------------------------|-----------------------------|---|--------------------------|----------------------------------|------------------------------------|
| RL0805N152 □3950◎TF | 1.5                            | 3950                        | 1.2   | <5sec                    | 2.0                              | 200                                |
| RL0805N202 □3950◎TF | 2.0                            | 3950                        | 1.0   |                          |                                  |                                    |
| RL0805N222 □3950◎TF | 2.2                            | 3950                        | 0.90  |                          |                                  |                                    |
| RL0805N332 □3950◎TF | 3.3                            | 3950                        | 0.72  |                          |                                  |                                    |
| RL0805N472 □3950◎TF | 4.7                            | 3950                        | 0.65  |                          |                                  |                                    |
| RL0805N502 □3950◎TF | 5.0                            | 3950                        | 0.60  |                          |                                  |                                    |
| RL0805N682 □3950◎TF | 6.8                            | 3950                        | 0.50  |                          |                                  |                                    |
| RL0805N103 □3450◎TF | 10                             | 3450                        | 0.40  |                          |                                  |                                    |
| RL0805N103 □3950◎TF | 10                             | 3950                        | 0.44  |                          |                                  |                                    |
| RL0805N153 □3500◎TF | 15                             | 3500                        | 0.32  |                          |                                  |                                    |
| RL0805N223 □4050◎TF | 22                             | 4050                        | 0.31  |                          |                                  |                                    |
| RL0805N333 □4050◎TF | 33                             | 4050                        | 0.24  |                          |                                  |                                    |
| RL0805N473 □4150◎TF | 47                             | 4150                        | 0.20  |                          |                                  |                                    |
| RL0805N503 □4150◎TF | 50                             | 4150                        | 0.18  |                          |                                  |                                    |
| RL0805N683 □4150◎TF | 68                             | 4150                        | 0.16  |                          |                                  |                                    |
| RL0805N104 □4250◎TF | 100                            | 4250                        | 0.14  |                          |                                  |                                    |
| RL0805N154 □4300◎TF | 150                            | 4300                        | 0.11  |                          |                                  |                                    |
| RL0805N224 □4350◎TF | 220                            | 4350                        | 0.08  |                          |                                  |                                    |
| RL0805N334 □4400◎TF | 330                            | 4400                        | 0.06  |                          |                                  |                                    |
| RL0805N474 □4500◎TF | 470                            | 4500                        | 0.05  |                          |                                  |                                    |
| RL0805N684 □4500◎TF | 680                            | 4500                        | 0.04  |                          |                                  |                                    |
| RL0805N135 □4700◎TF | 1300                           | 4700                        | 0.03  |                          |                                  |                                    |

※ □: Please specify the tolerance code of R25 (F=±1%, H=±3%, J=±5%, K=±10%).

※ ◎: Please specify the tolerance code of B value (F=±1%, H=±3%).

**TYPICAL ELECTRICAL CHARACTERISTICS**

