

# MSKSEMI 美森科

SEMICONDUCTOR



ESD



TVS



TSS



MOV



GDT



PLED

## **XC6228DXX2VR-G(MS)**

**Product specification**

## 产品描述

XC6228DXX2VR-G(MS) 系列是一组低压差 (LDO) 转换器, 具有 1.2V 至 5.5V 宽电压输入范围、低压差、低功耗和小型化封装的等特性。

XC6228DXX2VR-G(MS) 低至 2uA 低静态电流特性, 特别适合用于电池供电、长时间待机系统设备应用, 能帮助降低系统设备的 待机功耗, 有效延长待机时间和电池使用寿命。

XC6228DXX2VR-G(MS) 有带 EN 使能引脚的版本可选, 将 EN 脚拉低可进入关断模式, 此关断模式下静态电流可降至仅 100nA (典型值)。XC6228DXX2VR-G(MS) 系列支持输出电容采用陶瓷电容器, 在 1.2V 至 5.5V 的宽输入电压范围内和整个输出负载电流 0mA-300mA 范围内稳定工作。

## 产品特性

- 2uA 静态电流 (无负载)
- $\pm 2\%$  输出电压精度
- 300mA 输出电流能力
- 100nA 关断电流 (可选版本)
- 宽范围输入电压: 1.2V 至 5.5V
- 低压差: 0.18V ( $V_o=3.3V/I_o=300mA$  条件下)
- 支持固定输出电压: 1.2V, 1.5V, 1.8V, 2.5V, 2.8V, 3.0V, 3.3V
- 支持陶瓷电容或者钽电容
- 限流保护
- 过温保护

## 产品应用

- 手持式、电池供电设备
- 低功耗微处理器
- 笔记本电脑、掌上型电脑和 PDA
- 无线通讯设备
- 音频/视频设备
- 车载导航系统

## 封装脚位图

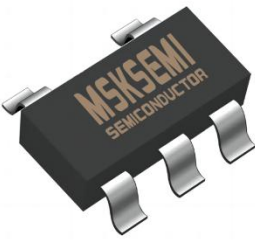
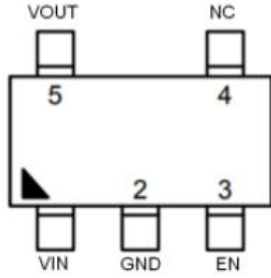
SOT-23-5	Pin Configurations
	

## 引脚功能描述

脚位号	名称	功能描述
2	GND	接地
5	VOUT	电压输出端口
1	VIN	电源输入端口
3	EN	使能控制
4	NC	浮空脚

产品信息

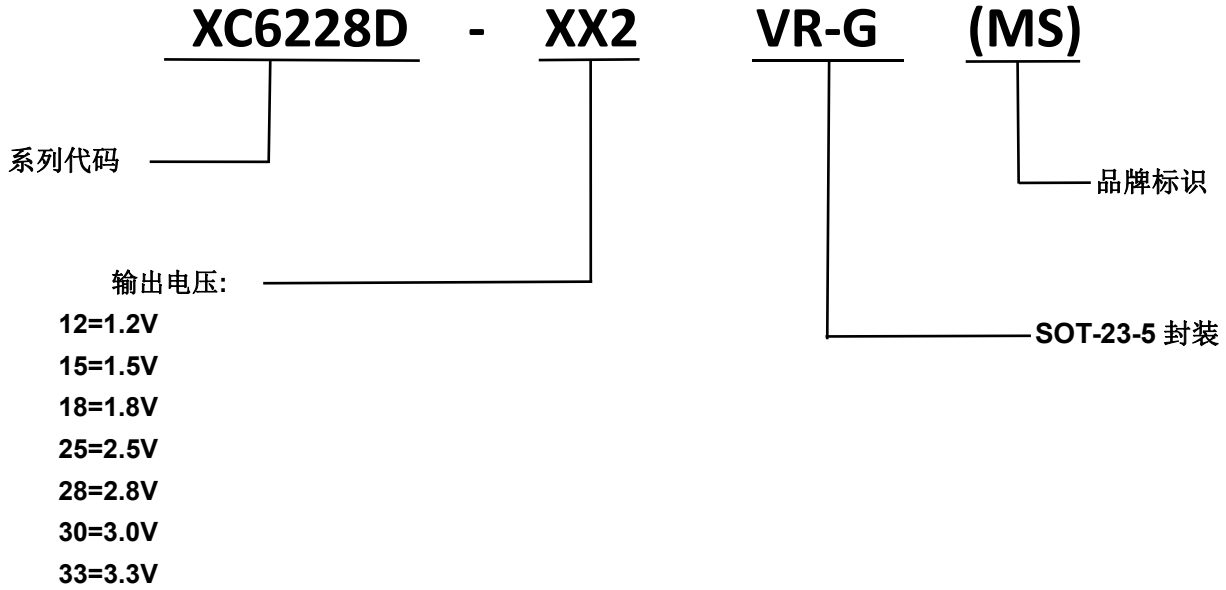

XC6228D122VR-G(MS)	XC6228D152VR-G(MS)
<b>AADB</b> ****	<b>AADG</b> ****
XC6228D182VR-G(MS)	XC6228D252VR-G(MS)
<b>AABB</b> ****	<b>AAET</b> ****
XC6228D282VR-G(MS)	XC6228D302VR-G(MS)
<b>AAC6</b> ****	<b>AADC</b> ****
XC6228D332VR-G(MS)	
<b>AAC7</b> ****	

典型应用电路



图 1: 固定输出应用电路



图 2: 带使能脚的固定输出应用电路

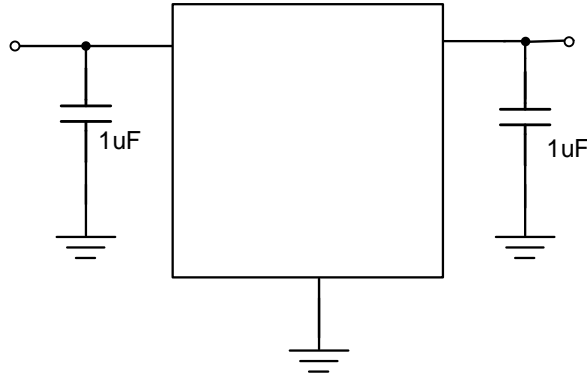

图 3: 固定输出带使能功能和输出电压检测功能之应用电路

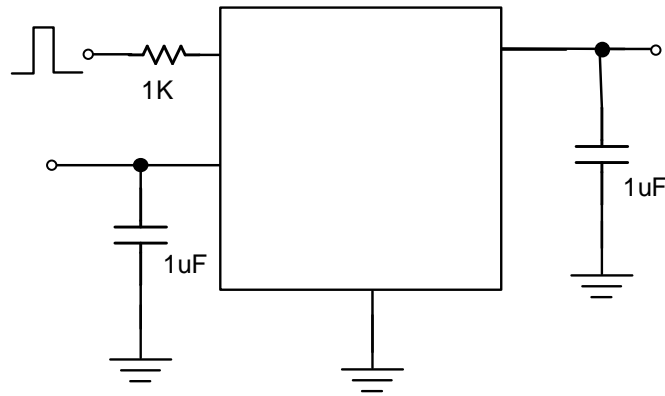

**最大耐压值** (Note 1)

VIN 至 GND	-0.3V to 7V
VOUT, EN 至 GND	-0.3V to 6V
VOUT 至 VIN	-6V to 0.3V
封装热阻 (Note 2)	
$\theta_{JA}$	200 °C /W
引脚焊锡温度 (Soldering, 10 sec.)	260 °C
结点温度	150 °C
存储温度范围	-60 °C to 150 °C
ESD 静电	
HBM	2KV
MM	200V
CDM	2KV

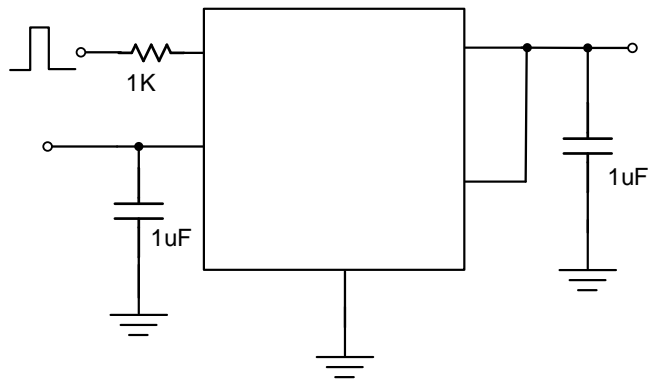
**建议应用条件**

输入电压 VIN	1.2V to 5.5V
应用结温范围	-40 °C to 125 °C
应用环温范围	-40 °C to 85 °C

**电气特性**

 ( $V_{IN} = 5V$ ,  $V_{EN} = 5V$   $T_A = 25^\circ C$  除另有说明外)

参数	符号	测试条件	最小值	典型值	最大值	单位	
输入电压	$V_{IN}$		1.2	--	5.5	V	
输出电压精准度		$I_{LOAD} = 0.1mA$	-2		2	%	
SNS 输入电流	$I_{SNS}$	$SNS = V_{OUT}$		0.5		$\mu A$	
Dropout 电压 ( $I_{LOAD} = 300mA$ ) (Note 3)	$V_{DROP\_3V}$	$V_{OUT} \geq 3V$		0.18		V	
	$V_{DROP\_2.8V}$	$V_{OUT} = 2.8V$		0.23			
	$V_{DROP\_2.5V}$	$V_{OUT} = 2.5V$		0.23			
	$V_{DROP\_1.8V}$	$V_{OUT} = 1.8V$		0.28			
	$V_{DROP\_1.5V}$	$V_{OUT} = 1.5V$		0.36			
	$V_{DROP\_1.2V}$	$V_{OUT} = 1.2V$		0.45			
静态电流	$I_Q$	$I_{LOAD} = 0mA$		2		$\mu A$	
关闭电流	$I_{SD}$	$V_{EN} = 0V$ , $V_{OUT} = 0V$		0.1	0.5	$\mu A$	
使能电压阈值	$V_{IH}$	EN Rising	1.0			V	
	$V_{IL}$	EN Falling			0.4		
EN 输入电流	$I_{EN}$	$V_{EN} = 5V$		10	100	nA	
输入电压调整率	$\Delta LINE$	$I_{LOAD} = 30mA$ , $1.5V \leq V_{IN} \leq 5.5V$ or $(V_{OUT} + 0.2V) \leq V_{IN} \leq 5.5V$		0.2		%	
负载电压调整率	$\Delta LOAD$	$10mA \leq I_{LOAD} \leq 0.3A$		0.2		%	
输出电流限流值	$I_{LIM}$	$V_{OUT} = 0V$	301	600		mA	
电源抑制比 ( $I_{LOAD} = 5mA$ )	PSRR	$V_{OUT} = 1.2V$ , $V_{IN} = 2V$	$f = 100Hz$	--	80	--	dB
			$f = 1kHz$	--	75	--	
输出电流噪声 ( $BW = 10Hz$ to $100kHz$ , $C_{OUT} = 1\mu F$ .)		$V_{IN} = 3.5V$ $I_{LOAD} = 0.1A$	$V_{OUT} = 1.2V$	--	80	--	$\mu V_{RMS}$
			$V_{OUT} = 2.8V$	--	120	--	
过温度关断温度	$T_{SD}$	$I_{LOAD} = 10mA$		--	155	--	$^\circ C$
过温度关断迟滞	$\Delta T_{SD}$			--	15	--	$^\circ C$
放电电阻	$R_{DC}$	$EN = 0V$ , $V_{OUT} = 0.1V$	--	30	--	$\Omega$	

**Note 1.** 任何超过“最大耐压值”的应用可能会导致芯片遭受永久性损坏。这些是额定最大耐压值，仅表示在这个范围内芯片不会损伤，但不保证所有性指标都正常，在任何超过“最大耐压值”的场合使用，都可能导致芯片永久性损坏。在接近或等于最大耐压值情况下使用，可能会影响产品可靠性。

**Note 2.**  $\theta_{JA}$  测量条件： $T_A = 25^\circ C$ ，使用 EVB 板。

**Note 3.**  $V_{DROP} = V_{IN} - V_{OUT}$  ( $V_{OUT}$  达到 98%标准值)。

典型电气特性

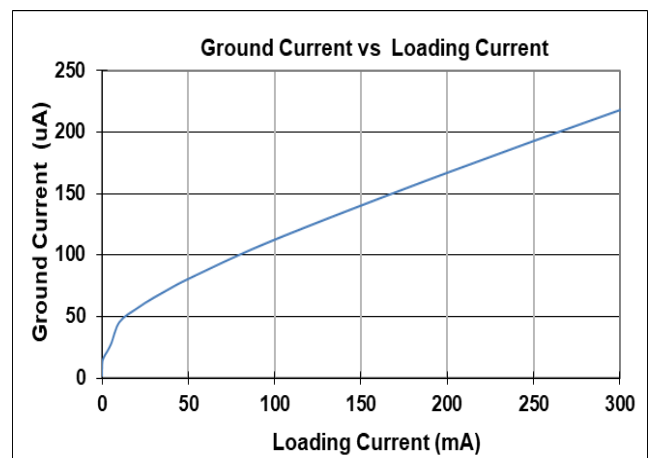
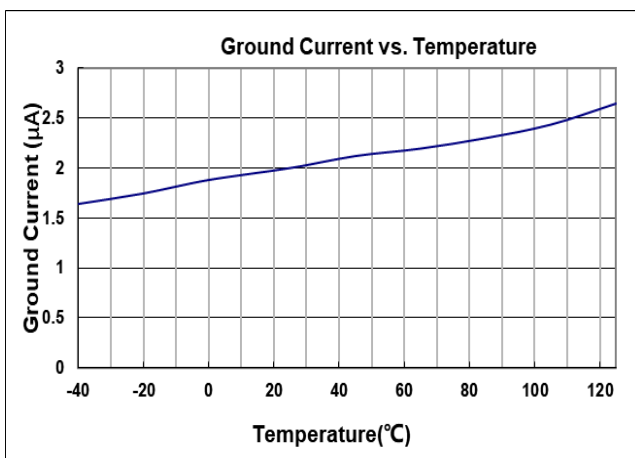
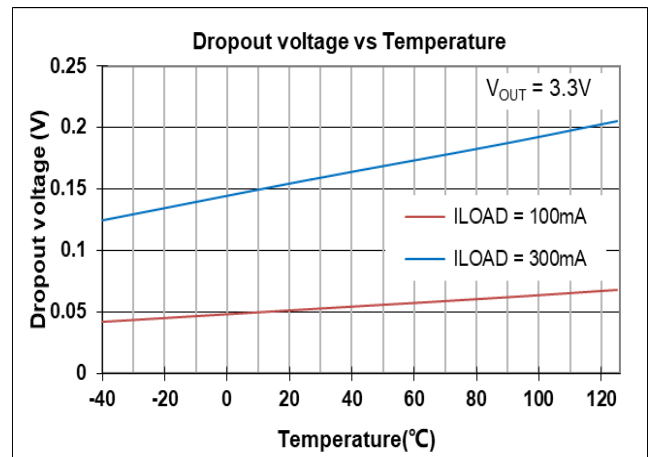
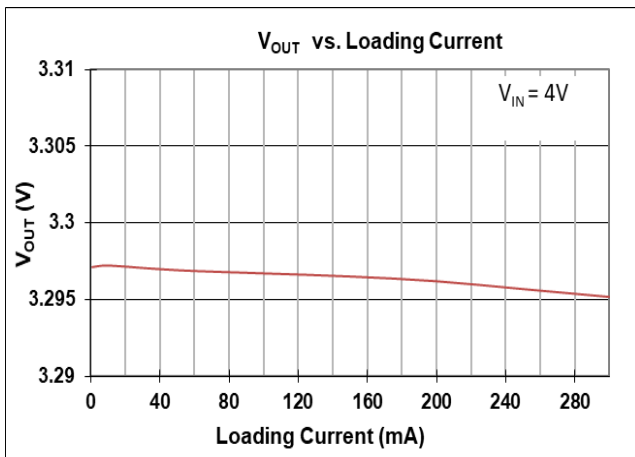
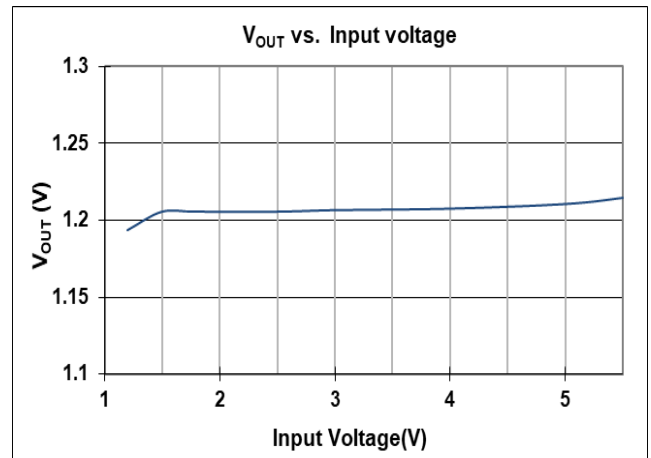
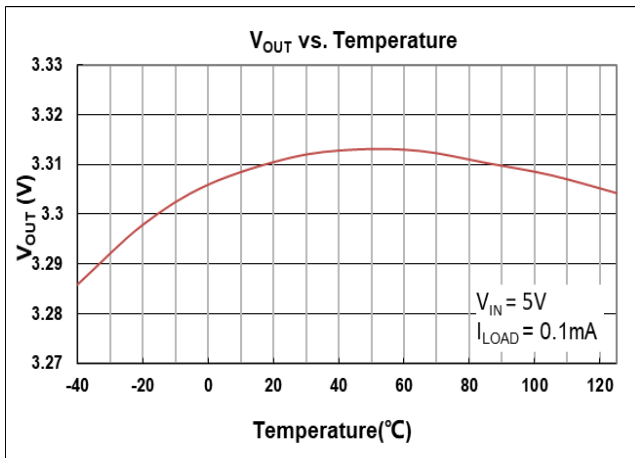



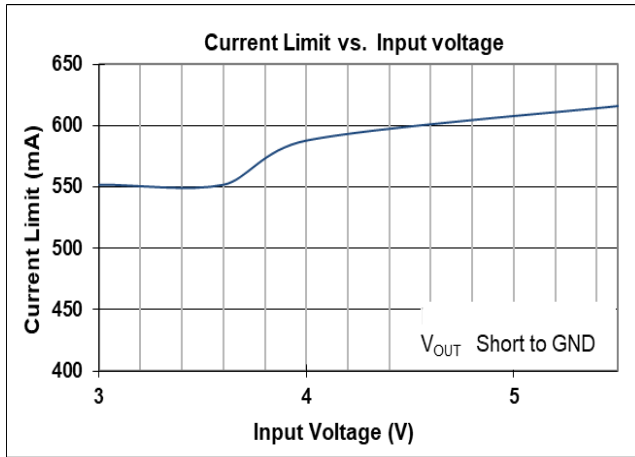
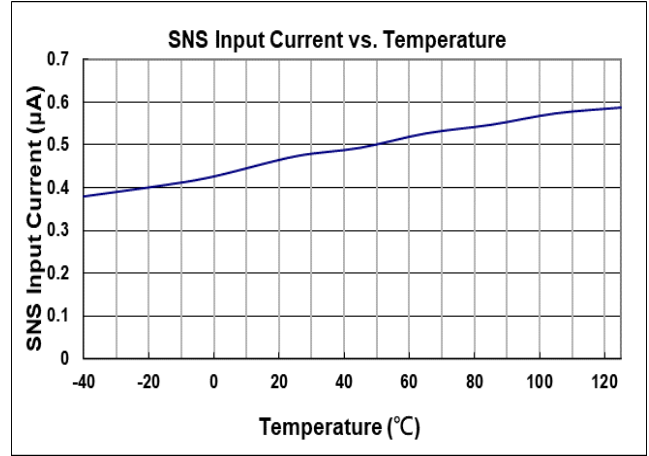
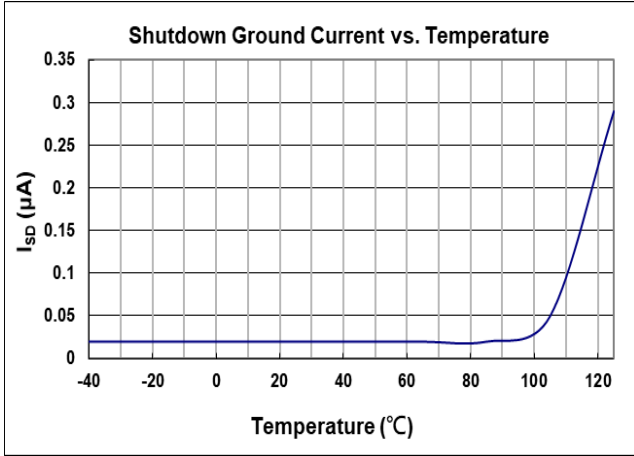

**Current Limit Response**

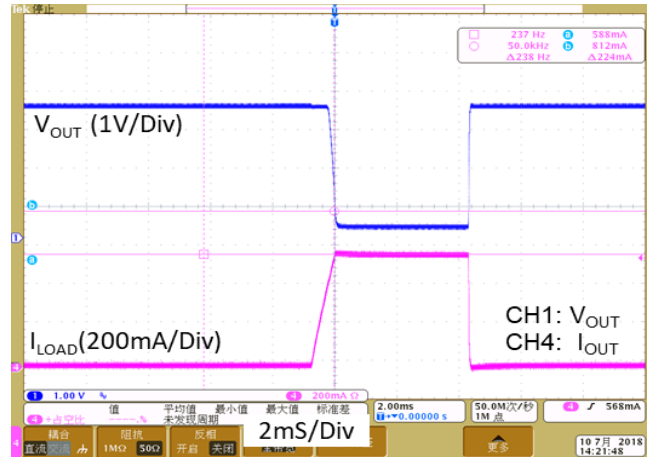

**Load Transient Response I**

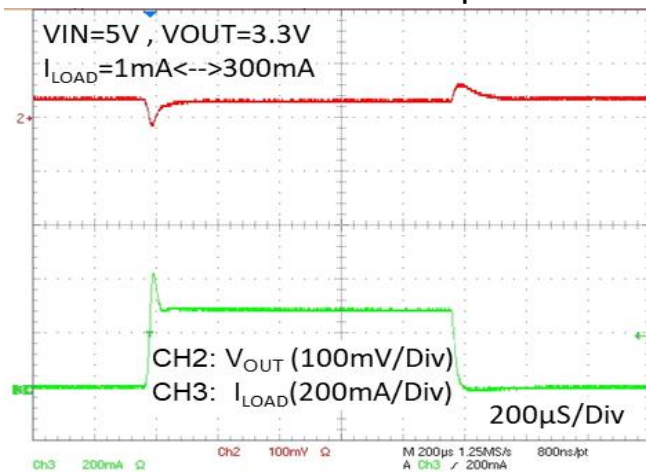

**Load Transient Response II**

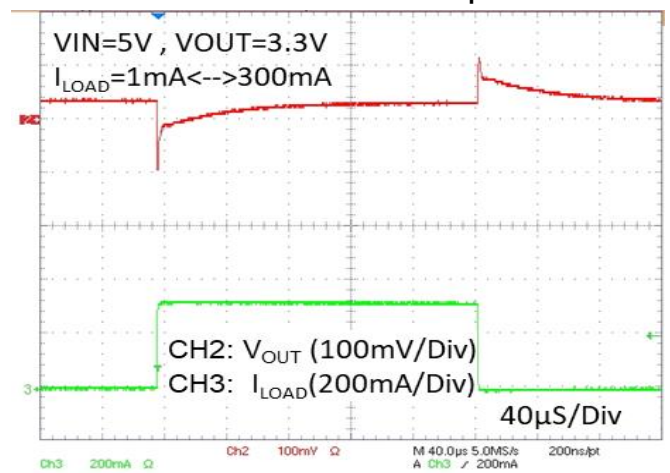

Line Transient Response

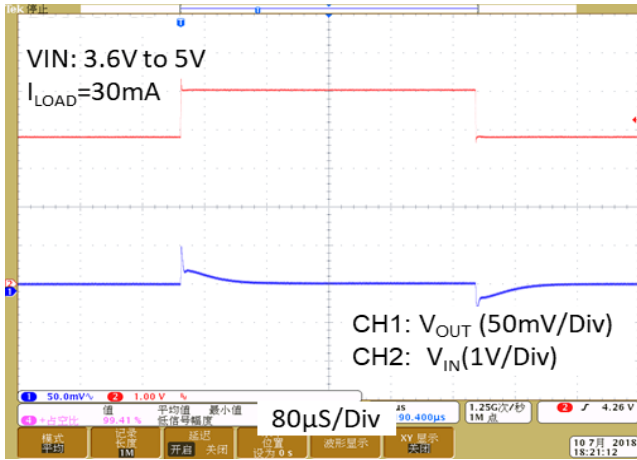

V<sub>OUT</sub> Turn On/Off by EN

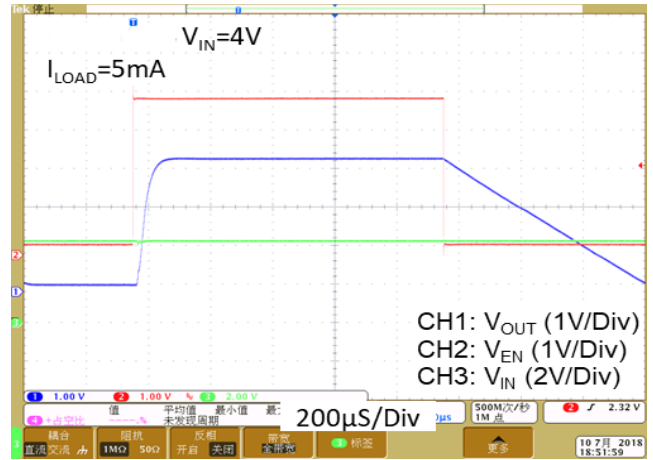

PSRR vs. Frequency

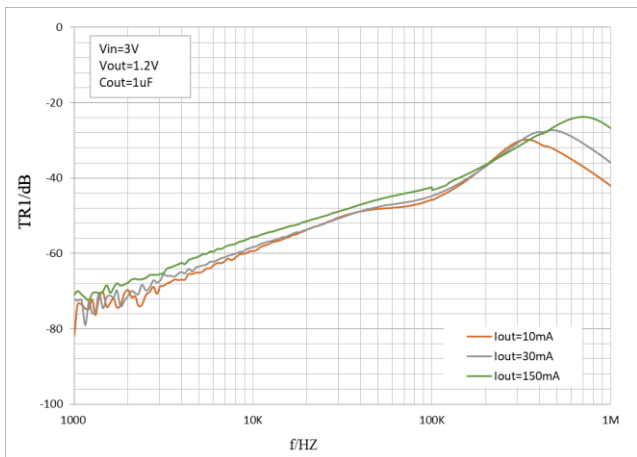

Noise Density Spectrum

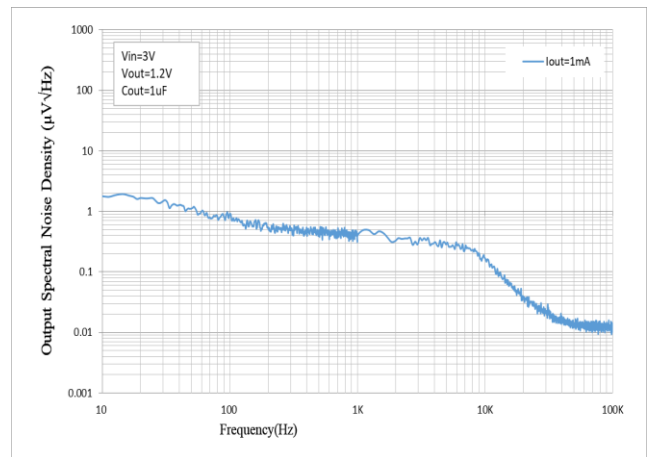

## 应用指导

### 输入和输出电容

XC6228DXX2VR-G(MS)系列产品应用, 需要选择合适的输入电容和输出电容, 以确保产品应用获得稳定可靠的性能。使用 1uF 或者更大容值的输入电容, 并将其靠近 IC 的VIN 和 GND pin 脚摆放。输出电容可选用 1mΩ以上 ESR (等效串联阻抗), 有效容值 1uF 至 22uF 的电容。并将输出电容靠近IC 的 V<sub>OUT</sub> 和 GND 脚摆放。增加输出电容的容值和降低ESR 能够提升电路的 PSRR 和瞬态响应能力。

### Dropout 电压

XC6228DXX2VR-G(MS)系列采用 PMOS 传输晶体管来实现低压差。当 (V<sub>IN</sub> - V<sub>OUT</sub>) 小于 (V<sub>DRO</sub>)时, PMOS 晶体管处于线性工作区域, 输入至输出阻抗即为 PMOS 的 R<sub>DS(ON)</sub>, 在此状态下, PMOS 等效于一颗电阻, V<sub>DRO</sub> 和输出电流近似成比例。和其他线性电压转换器一样, XC6228DXX2VR-G(MS) 系列的PSRR和瞬态响应能力会随着 (V<sub>IN</sub> - V<sub>OUT</sub>)压差接近V<sub>DRO</sub> 而下降。

## Layout 注意事项

将输入电容、输出电容和 LDO 放置在 PCB 的同一面, 并尽量将电容器靠近 IC 的输入输出脚摆放, 可实现电路最佳性能。输入电容和输出电容的接地连接必须拉回到 XC6228DXX2VR-G(MS) 的接地引脚, 并使用短而粗的铺线连接。避免使用长走线、窄走线、或者通过过孔走线, 这些会增加寄生电感和电阻, 导致电路性能变差, 特别是在瞬态工作条件下。

### 电流限制功能

XC6228DXX2VR-G(MS)系列产品内部的电流限制器可持续监控及控制输出功率晶体管, 将输出电流限制至 600mA (典型值)。限流功能确保输出可以短路至地, 器件不会损坏。

### OTP (过温度保护)

当产品的结点温度超过 155°C (典型值) 时, XC6228DXX2VR-G(MS)会关闭P-MOS 关闭输出。当结点温度往回降大约 15°C 时, XC6228DXX2VR-G(MS)会重新自动重启工作。

### 热散功率

持续工作时, IC 的结点温度不应超过其额定值。最大的热散功率取决于 IC 封装的热阻、PCB 布图、周围气流速率以及结点和环境温度的差异。最大热散功率计算如下:

环温 T<sub>A</sub>=25°C, 使用 MSKSEMI PCB,

$$PD(\text{Max}) = (125^\circ\text{C} - 25^\circ\text{C}) / (200^\circ\text{C}/\text{W}) = 0.5\text{W}$$

热散功率(PD)等于输出电流和 LDO 上的压降的乘积, 计算公式如下:

$$PD = (V_{IN} - V_{OUT}) \times I_{OUT}$$

**Package Outline Dimensions**

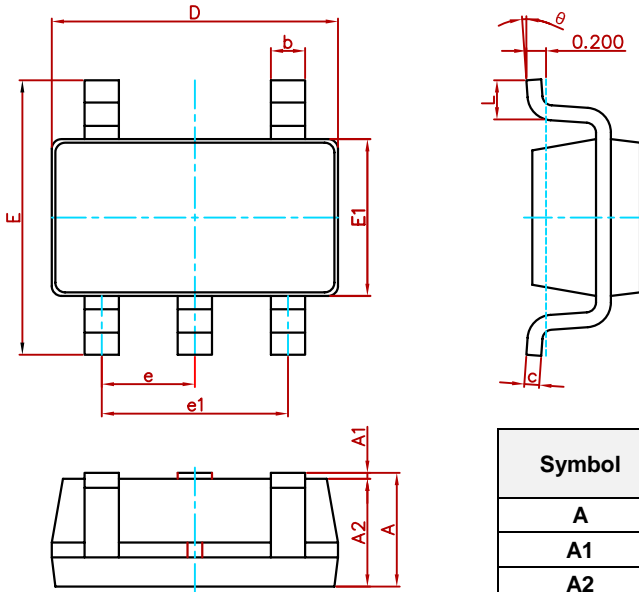

Symbol	Dimensions In Millimeters		Dimensions In Inches	
	Min.	Max.	Min.	Max.
A	1.050	1.250	0.041	0.049
A1	0.000	0.100	0.000	0.004
A2	1.050	1.150	0.041	0.045
b	0.300	0.500	0.012	0.020
c	0.100	0.200	0.004	0.008
D	2.820	3.020	0.111	0.119
E	2.650	2.950	0.104	0.116
E1	1.500	1.700	0.059	0.067
e	0.950(BSC)		0.037(BSC)	
e1	1.800	2.000	0.071	0.079
L	0.300	0.600	0.012	0.024
θ	0°	8°	0°	8°

**Suggested Pad Layout**

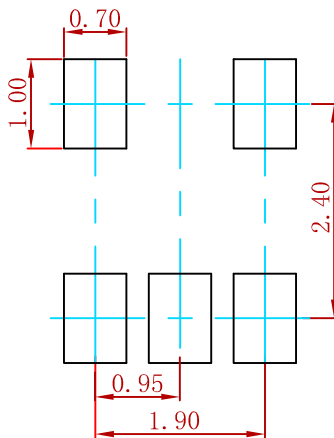

- Note:
1. Controlling dimension: in millimeters.
  2. General tolerance:  $\pm 0.05\text{mm}$ .
  3. The pad layout is for reference purposes only.

## 订购信息

订单型号	封装形式	包装/数量
XC6228D122VR-G(MS)	SOT-23-5	盘装/3000pcs
XC6228D152VR-G(MS)	SOT-23-5	盘装/3000pcs
XC6228D182VR-G(MS)	SOT-23-5	盘装/3000pcs
XC6228D252VR-G(MS)	SOT-23-5	盘装/3000pcs
XC6228D282VR-G(MS)	SOT-23-5	盘装/3000pcs
XC6228D302VR-G(MS)	SOT-23-5	盘装/3000pcs
XC6228D332VR-G(MS)	SOT-23-5	盘装/3000pcs

## Attention

- Any and all MSKSEMI Semiconductor products described or contained herein do not have specifications that can handle applications that require extremely high levels of reliability, such as life-support systems, aircraft's control systems, or other applications whose failure can be reasonably expected to result in serious physical and/or material damage. Consult with your MSKSEMI Semiconductor representative nearest you before using any MSKSEMI Semiconductor products described or contained herein in such applications.
- MSKSEMI Semiconductor assumes no responsibility for equipment failures that result from using products at values that exceed, even momentarily, rated values (such as maximum ratings, operating condition ranges, or other parameters) listed in products specifications of any and all MSKSEMI Semiconductor products described or contained herein.
- Specifications of any and all MSKSEMI Semiconductor products described or contained herein stipulate the performance, characteristics, and functions of the described products in the independent state, and are not guarantees of the performance, characteristics, and functions of the described products as mounted in the customer's products or equipment. To verify symptoms and states that cannot be evaluated in an independent device, the customer should always evaluate and test devices mounted in the customer's products or equipment.
- MSKSEMI Semiconductor strives to supply high-quality high-reliability products. However, any and all semiconductor products fail with some probability. It is possible that these probabilistic failures could give rise to accidents or events that could endanger human lives, that could give rise to smoke or fire, or that could cause damage to other property. When designing equipment, adopt safety measures so that these kinds of accidents or events cannot occur. Such measures include but are not limited to protective circuits and error prevention circuits for safe design, redundant design, and structural design.
- In the event that any or all MSKSEMI Semiconductor products (including technical data, services) described or contained herein are controlled under any of applicable local export control laws and regulations, such products must not be exported without obtaining the export license from the authorities concerned in accordance with the above law.
- No part of this publication may be reproduced or transmitted in any form or by any means, electronic or mechanical, including photocopying and recording, or any information storage or retrieval system, or otherwise, without the prior written permission of MSKSEMI Semiconductor.
- Information (including circuit diagrams and circuit parameters) herein is for example only ; it is not guaranteed for volume production. MSKSEMI Semiconductor believes information herein is accurate and reliable, but no guarantees are made or implied regarding its use or any infringements of intellectual property rights or other rights of third parties.
- Any and all information described or contained herein are subject to change without notice due to product/technology improvement, etc. When designing equipment, refer to the "Delivery Specification" for the MSKSEMI Semiconductor product that you intend to use.