

600V N-Channel MOSFET

Features

V _{DSS}	R _{DS ON} @ 10V (Typ)	I _D
600V	8.5 Ω	1A

- Fast switching
- 100% avalanche tested
- Improved dv/dt capability
- RoHS Compliant

Application

- Switch Mode Power Supply (SMPS)
- Uninterruptible Power Supply (UPS)
- Power Factor Correction (PFC)

Package

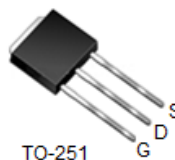
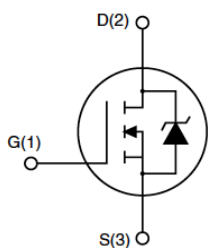

Ordering Information

Part Number	Marking	Case	Packaging
G1N60B	G1N60	TO-251	72pcs/Tube
G1N60K	G1N60	TO-252	2500pcs/Reel

Absolute Maximum Ratings $T_C = 25^\circ\text{C}$, unless otherwise noted

Parameter	Symbol	Value		Unit
		TO-251	TO-252	
Drain-Source Voltage ($V_{GS} = 0V$)	V_{DSS}	600		V
Continuous Drain Current	I_D	1.0		A
Pulsed Drain Current (note1)	I_{DM}	3.6		A
Gate-Source Voltage	V_{GSS}	± 30		V
Single Pulse Avalanche Energy (note2)	E_{AS}	30		mJ
Avalanche Current (note1)	I_{AR}	2.59		A
Repetitive Avalanche Energy (note1)	E_{AR}	18		mJ
Power Dissipation ($T_C = 25^\circ\text{C}$)	P_D	17		W
Operating Junction and Storage Temperature Range	T_J, T_{stg}	-55~+150		$^\circ\text{C}$

Thermal Resistance				
Parameter	Symbol	Value		Unit
		TO-251	TO-252	
Thermal Resistance, Junction-to-Case	R_{thJC}	7.3		°C/W
Thermal Resistance, Junction-to-Ambient	R_{thJA}	60		

Specifications $T_J = 25^\circ\text{C}$, unless otherwise noted						
Parameter	Symbol	Test Conditions	Value			Unit
			Min.	Typ.	Max.	
Static						
Drain-Source Breakdown Voltage	$V_{(BR)DSS}$	$V_{GS} = 0V, I_D = 250\mu A$	600	--	--	V
Zero Gate Voltage Drain Current	I_{DSS}	$V_{DS} = 600V, V_{GS} = 0V, T_J = 25^\circ\text{C}$	--	--	1	μA
Gate-Source Leakage	I_{GSS}	$V_{GS} = \pm 30V$	--	--	± 100	nA
Gate-Source Threshold Voltage	$V_{GS(th)}$	$V_{DS} = V_{GS}, I_D = 250\mu A$	3.0	--	4.2	V
Drain-Source On-Resistance (Note3)	$R_{DS(on)}$	$V_{GS} = 10V, I_D = 0.45A$	--	8.5	10	Ω
Dynamic						
Input Capacitance	C_{iss}	$V_{GS} = 0V,$ $V_{DS} = 25V,$ $f = 1.0\text{MHz}$	--	135	--	pF
Output Capacitance	C_{oss}		--	13	--	
Reverse Transfer Capacitance	C_{rss}		--	1.2	--	
Total Gate Charge	Q_g	$V_{DD} = 480V, I_D = 0.9A,$ $V_{GS} = 10V$	--	5	--	nC
Gate-Source Charge	Q_{gs}		--	0.9	--	
Gate-Drain Charge	Q_{gd}		--	3.1	--	
Turn-on Delay Time	$t_{d(on)}$	$V_{DD} = 300V, I_D = 0.9A,$ $R_G = 25\Omega$	--	34	--	ns
Turn-on Rise Time	t_r		--	6.3	--	
Turn-off Delay Time	$t_{d(off)}$		--	43	--	
Turn-off Fall Time	t_f		--	43.4	--	
Drain-Source Body Diode Characteristics						
Continuous Body Diode Current	I_S	$T_C = 25^\circ\text{C}$	--	--	1.0	A
Pulsed Diode Forward Current	I_{SM}		--	--	3.6	
Body Diode Voltage	V_{SD}	$T_J = 25^\circ\text{C}, I_{SD} = 0.45A, V_{GS} = 0V$	--	--	1.4	V
Reverse Recovery Time	t_{rr}	$V_{GS} = 0V, I_S = 0.9A,$ $di_F/dt = 100A/\mu s$	--	634	--	ns
Reverse Recovery Charge	Q_{rr}		--	338	--	nC

Notes

1. Repetitive Rating: Pulse width limited by maximum junction temperature
2. $L=10\text{mH}, V_{DD} = 50V, R_G = 25\Omega$, Starting $T_J = 25^\circ\text{C}$
3. Pulse Test: Pulse width $\leq 300\mu s$, Duty Cycle $\leq 1\%$

Typical Characteristics $T_J = 25^\circ\text{C}$, unless otherwise noted

Figure 1. Output Characteristics ($T_J = 25^\circ\text{C}$)

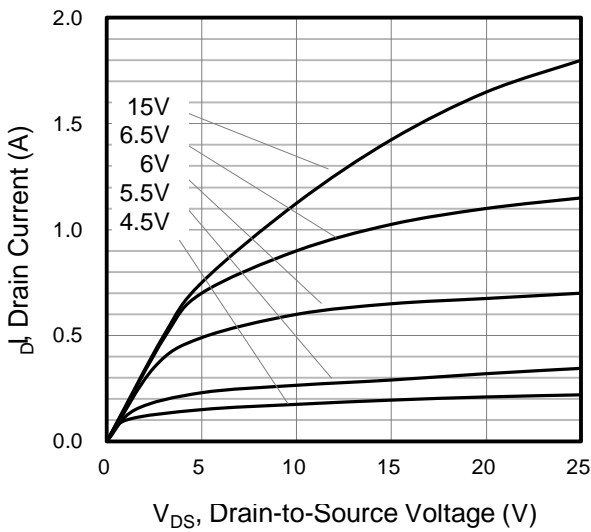

Figure 2. Body Diode Forward Voltage

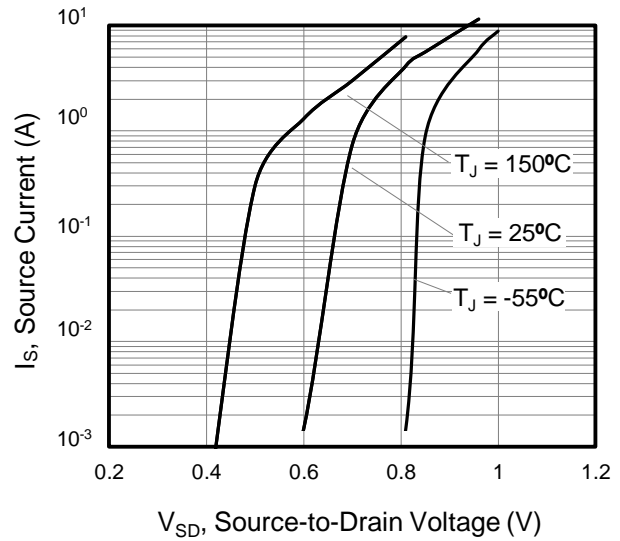

Figure 3. Drain Current vs. Temperature

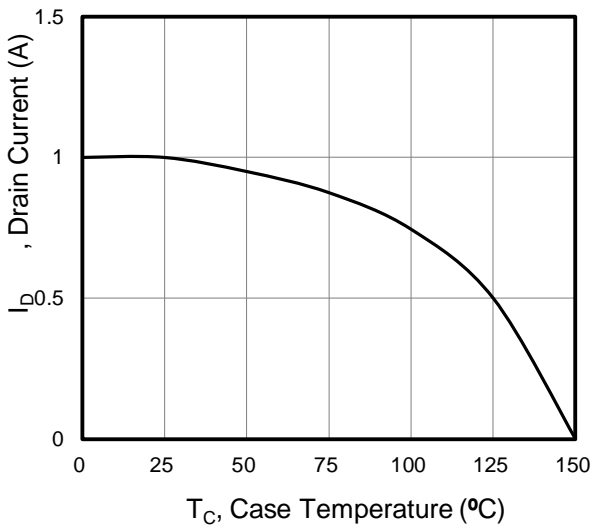

Figure 4. Power Dissipation vs. Temperature TO-251, TO-252

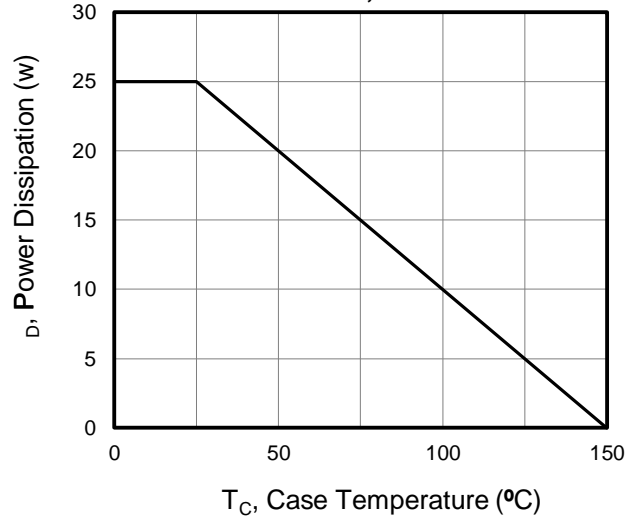

Figure 5. Transfer Characteristics

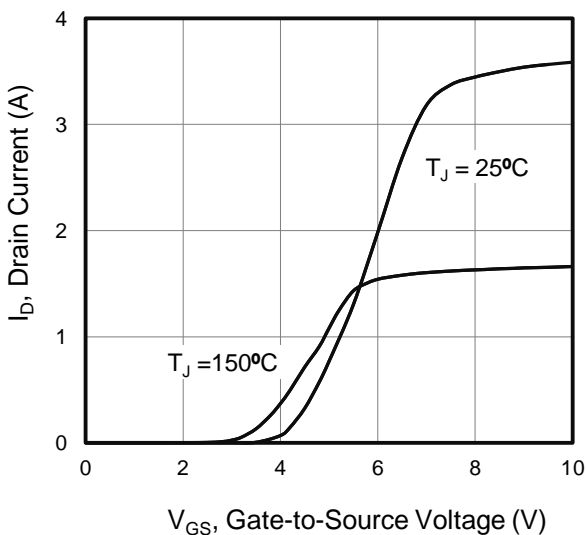
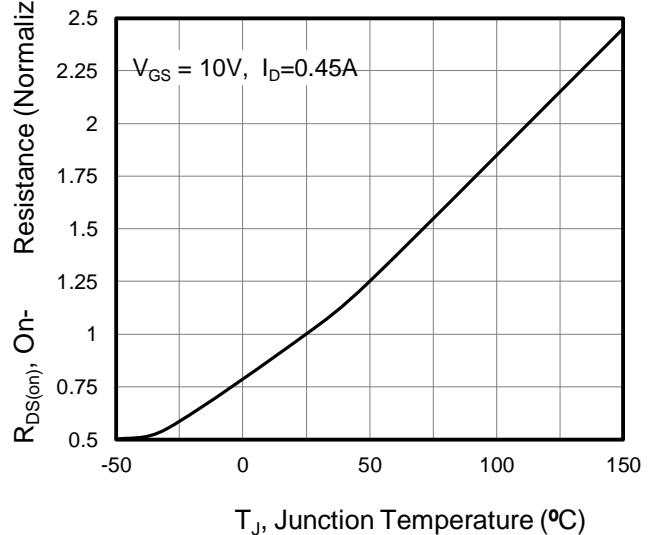

Figure 6. On-Resistance vs. Temperature



Typical Characteristics $T_J = 25^\circ\text{C}$, unless otherwise noted

Figure 7. Capacitance

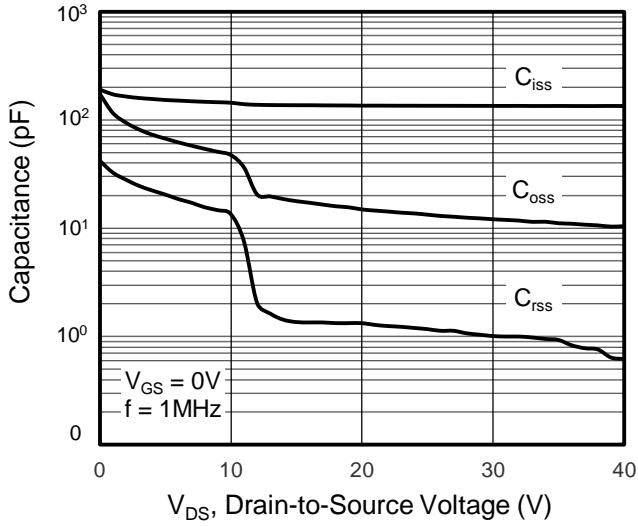

Figure 8. Gate Charge

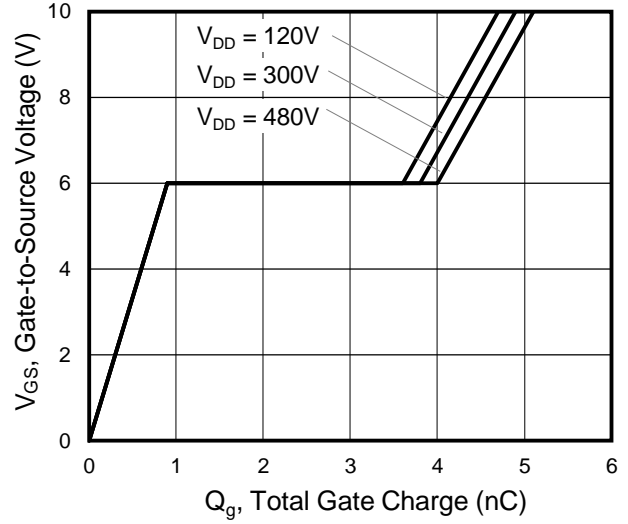

Figure 9. Transient Thermal Impedance TO-251, TO-252

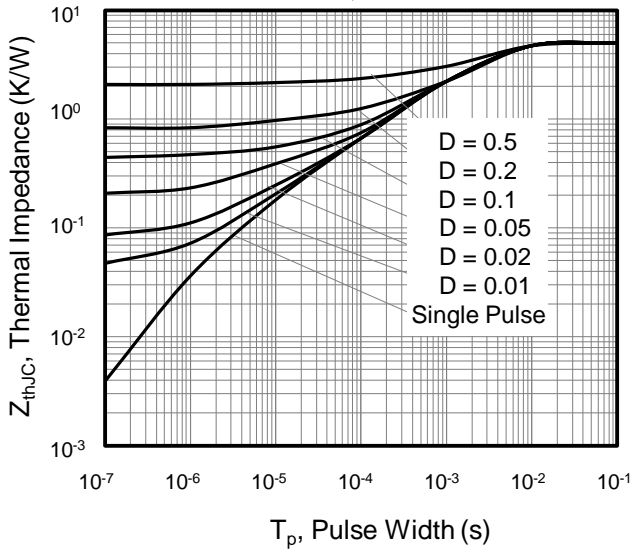

Figure A: Gate Charge Test Circuit and Waveform

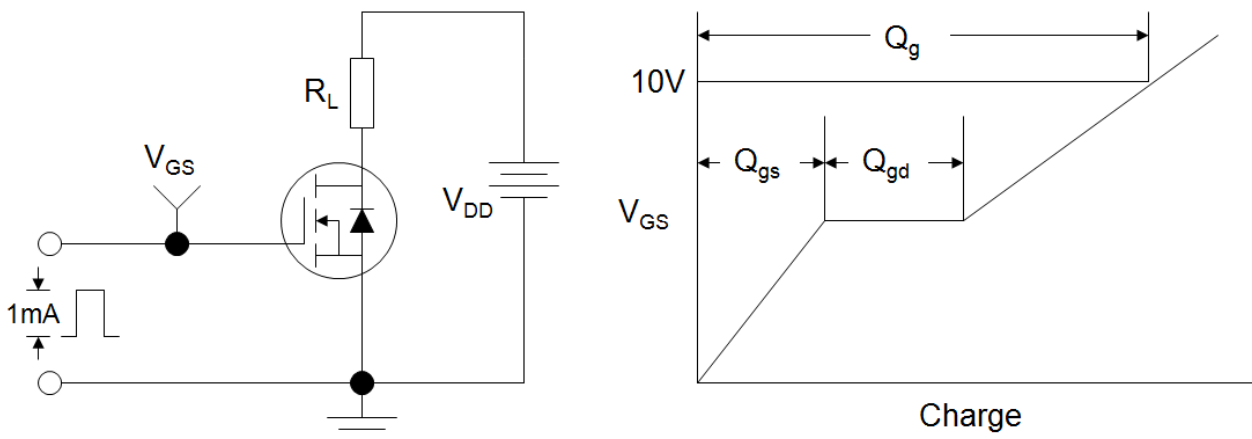

Figure B: Resistive Switching Test Circuit and Waveform

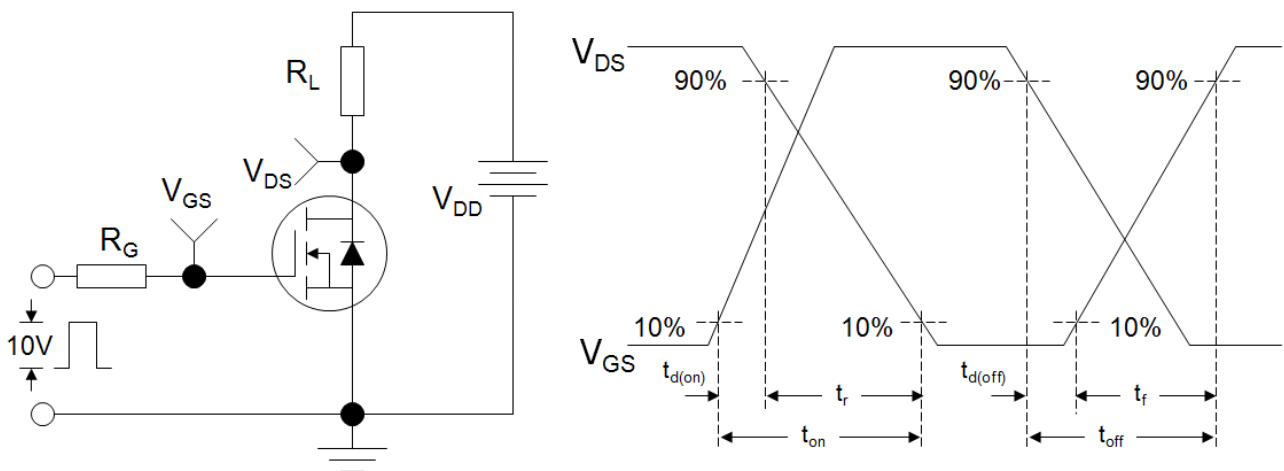
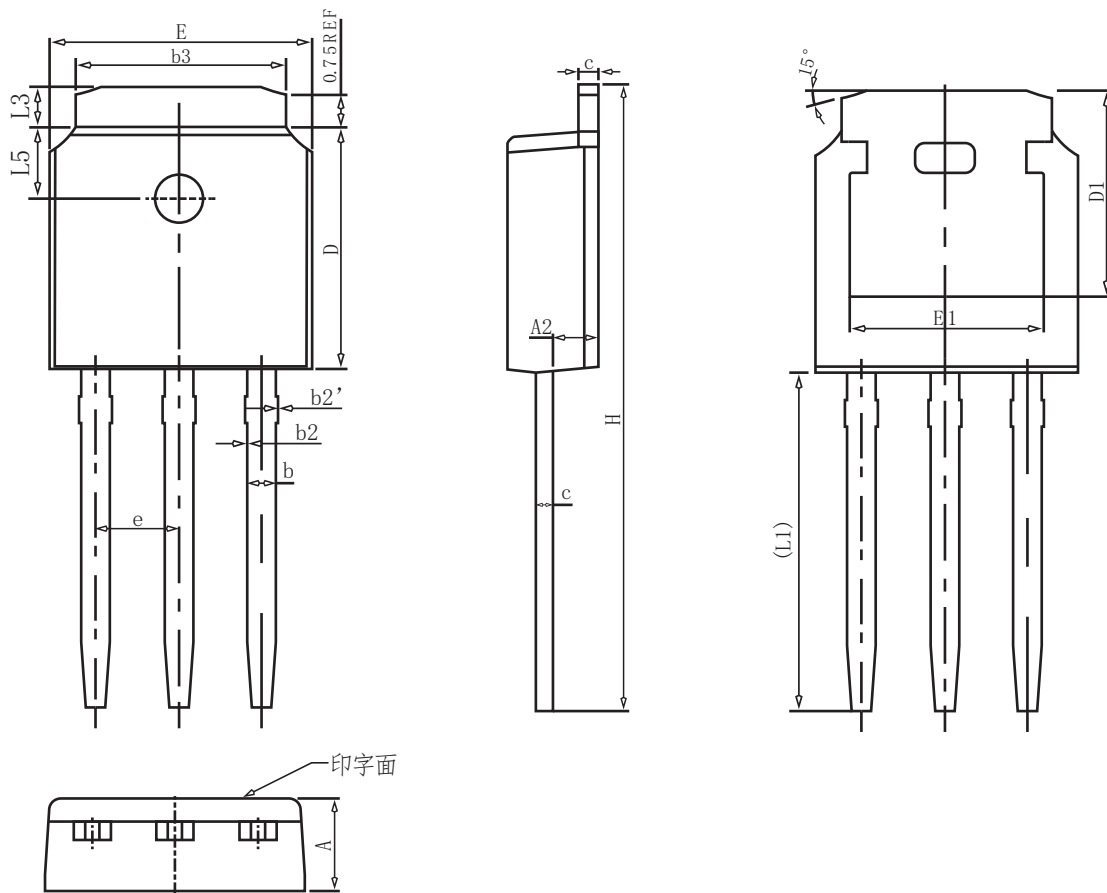

Figure C: Unclamped Inductive Switching Test Circuit and Waveform



TO-251 Package information



COMMON DIMENSIONS

SYMBOL	mm		
	MIN	NOM	MAX
A	2.20	2.30	2.40
A2	0.97	1.07	1.17
b	0.68	0.78	0.90
b2	0.00	0.04	0.10
b2'	0.00	0.04	0.10
b3	5.20	5.33	5.50
c	0.43	0.53	0.63
D	5.98	6.10	6.22
D1	5.30REF		
E	6.40	6.60	6.80
E1	4.63	-	-
e	2.286BSC		
H	16.22	16.52	16.82
L1	9.15	9.40	9.65
L3	0.88	1.02	1.28
L5	1.65	1.80	1.95

TO-252 Package information

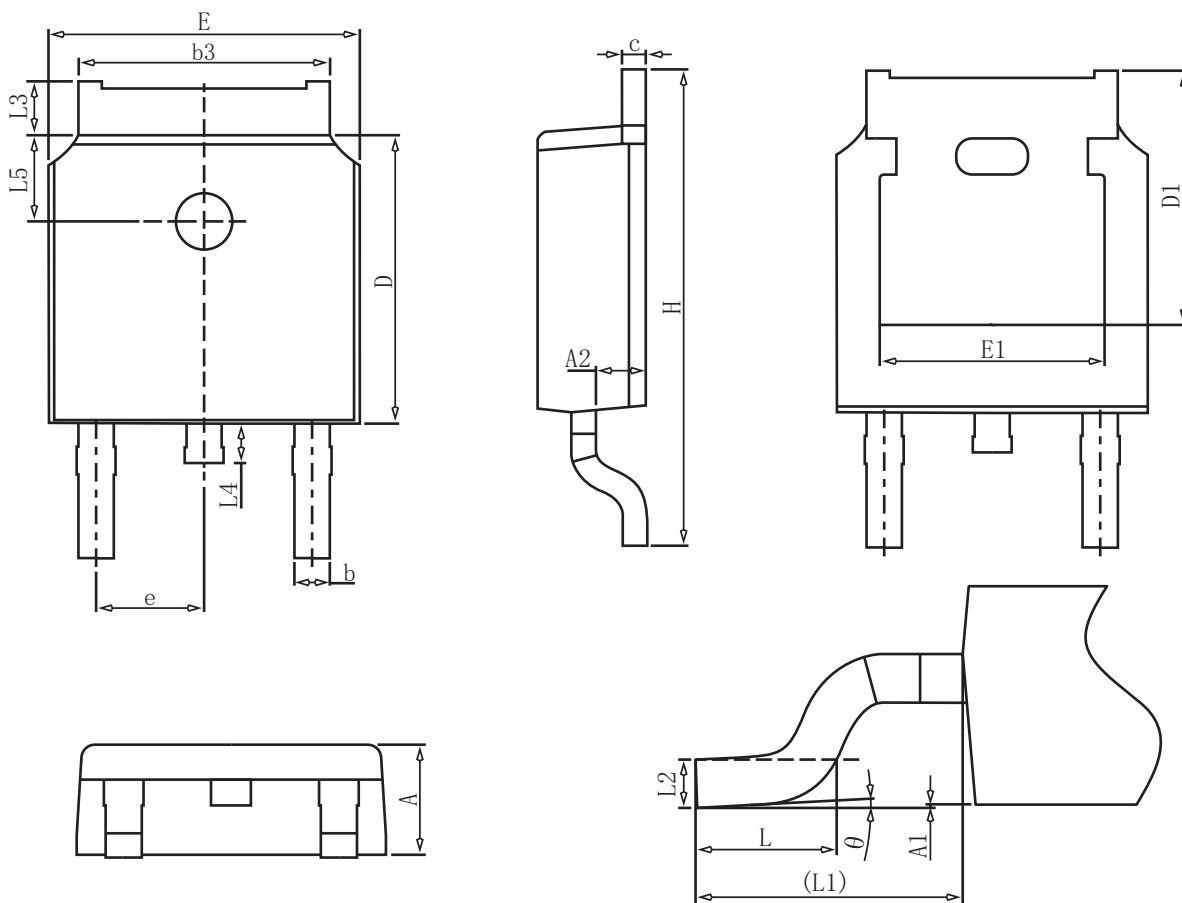

COMMON DIMENSIONS

SYMBOL	mm		
	MIN	NOM	MAX
A	2.20	2.30	2.40
A1	0.00	-	0.20
A2	0.97	1.07	1.17
b	0.68	0.78	0.90
b3	5.20	5.33	5.50
c	0.43	0.53	0.63
D	5.98	6.10	6.22
D1	5.30REF		
E	6.40	6.60	6.80
E1	4.63	-	-
e	2.286BSC		
H	9.40	10.10	10.50
L	1.38	1.50	1.75
L1	2.90REF		
L2	0.51BSC		
L3	0.88	-	1.28
L4	0.50	-	1.00
L5	1.65	1.80	1.95
θ	0°	-	8°