



信昌電子陶瓷股份有限公司  
Prosperity Dielectrics Co., Ltd.

No.220-1, Sec. 2, Nanshan Rd., Lujhu, Taoyuan 33860, Taiwan, R.O.C.  
Tel. : 886-3-3224471 Fax : 886-3-3212216

Messrs. : 一般共用

Date : 2017 / 09 / 15

# APPROVAL SHEET

Product Name : High Capacitance Multilayer Ceramic Chip Capacitors

Part No. : FS Series

Description : Size  $\leq 2225$ , Capacitance  $\geq 1\mu F$ ,  $U_R < 1000V$

PREPARED BY	APPROVED BY

信昌電子陶瓷股份有限公司

PROSPERITY DIELECTRICS CO., LTD.

桃園縣蘆竹鄉南山路二段 220-1 號 <http://www.pdc.com.tw>

Tel: 03-322-4471 ext: Fax: 03-322-5231 / 03-321-2215

Contact: \_\_\_\_\_ Mobile: \_\_\_\_\_





信昌電子陶瓷股份有限公司  
**Prosperity Dielectrics Co., Ltd.**

No.220-1, Sec. 2, Nanshan Rd., Lujhu, Taoyuan 33860, Taiwan, R.O.C.  
Tel. : 886-3-3224471 Fax : 886-3-3212216

# SPECIFICATION

FOR

**Product Name : High Capacitance Multilayer Ceramic Chip Capacitors**

**Part No. : FS Series**

**Description : Size  $\leq 2225$ , Capacitance  $\geq 1\mu F$ ,  $U_R < 1000V$**

<b>SPEC. No. : <u>FS-000-001-06</u></b>
<b>DATE : <u>2017/09/15</u></b>

DRAWN BY	CHECEKED BY	APPROVED BY
<b>Yvens Chou</b>	<b>Yvens Chou</b>	<b>Ryan Chen</b>



# 1. INTRODUCTION

PDC FS Series green type capacitors are manufactured by using environmental friendly material without lead or cadmium. These capacitors feature series connection of multi-layer capacitor units in a MLCC to realize high voltage performance. This special design can distribute voltage gradients throughout the entire capacitor, so as to prevent short circuit failure. It is a safety design for LCD back-lighting inverter application.

# 2. FEATURES

- a. Realize high capacitance in small sizes.
- b. Capacitor with lead-free termination (pure Tin).
- c. RoHS compliant.
- d. HALOGEM compliant.
- e. Surface mount suited for wave and reflow soldering.
- f. High reliability and no polarity.

# 3. APPLICATIONS

- a. Digital circuit coupling or decoupling applications.
- b. For bypassing.
- c. Ideal for smoothing circuits.
- d. DC to DC converter.

# 4. HOW TO ORDER

<u>FS</u>	<u>21</u>	<u>X</u>	<u>471</u>	<u>K</u>	<u>500</u>	<u>P</u>	<u>X</u>	<u>G</u>
PDC Family	Size	Dielectric	Capacitance	Tolerance	Rated Voltage	Packaging	Thickness	Control Code
Table 1	Table 2	Table 3	Table 4	Table 5	Table 6	Table 7	Table 8	Table 9

Table 1		PDC Family			
Code	Description				
FS	High Capacitance Capacitor $\geq 1\mu\text{F}(105)$				

Table 2		General Purpose			
Code	Description	Code	Description	Code	Description
03	0201 (0603)	31	1206 (3216)	46	1825 (4563)
15	0402 (1005)	32	1210 (3225)	52	2211 (5728)
18	0603 (1608)	42	1808 (4520)	55	2220 (5750)
21	0805 (2012)	43	1812 (4532)	56	2225 (5763)

Table 3		Dielectric Material Characteristics	
Code	Description	Code	Description
N	C0G	X	X7R
B	X5R	F	Y5V
S	X6S		

Table 4		Capacitance Rule Code	
Code	Description	Code	Description
R47	0.47pF	102	$102=10 \times 10^2=1000\text{pF}$
0R5	0.5pF	104	$104=10 \times 10^4=100\text{nF}$
100	$100=10 \times 10^0=10\text{pF}$	106	$106=10 \times 10^6=10\mu\text{F}$

Table 5		Tolerance			
Code	Description	Code	Description	Code	Description
A	$\pm 0.05 \text{ pF}$	I	-10% ~ 0%	Q	$\pm 0.03 \text{ pF}$
B	$\pm 0.10 \text{ pF}$	J	$\pm 5 \%$	Z	-20% ~ +80%
C	$\pm 0.25 \text{ pF}$	K	$\pm 10 \%$	X	+10% ~ +20%
D	$\pm 0.50 \text{ pF}$	L	0% ~ +10%		
F	$\pm 1 \%$	M	$\pm 20 \%$		
G	$\pm 2 \%$	N	-5% ~ +10%		
H	$\pm 3 \%$	P	$\pm 0.02 \text{ pF}$		

Table 6		Rated Voltage			
Code	Description	Code	Description	Code	Description
6R3	6.3Vdc	201	200Vdc	152	1500Vdc
100	10Vdc	251	250Vdc	202	2000Vdc
160	16Vdc	401	400Vdc	302	3000Vdc
250	25Vdc	501	500Vdc	402	4000Vdc
500	50Vdc	631	630Vdc	502	5000Vdc
101	100Vdc	102	1000Vdc	602	6000Vdc

Table 7		Packaging Type	
Code	Description	Code	Description
B	Bulk	T	Tray package
E	Tape and 7" Reel, Embossed Tape	P	Tape and 7" Reel, Paper Tape
K	Tape and 10" Reel, Embossed Tape	D	Tape and 10" Reel, Paper Tape
L	Tape and 13" Reel, Embossed Tape	G	Tape and 13" Reel, Paper Tape

Table 8		Thickness Description			
Code	Description	Code	Description	Code	Description
A	$0.60 \pm 0.10 \text{ mm}$	I	$1.25 \pm 0.20 \text{ mm}$	Q	$0.50 \pm 0.02/-0.05 \text{ mm}$
B	$0.8 + 0.15/-0.10 \text{ mm}$	J	$1.15 \pm 0.15 \text{ mm}$	R	$3.10 \pm 0.30 \text{ mm}$
C	$1.25 \pm 0.10 \text{ mm}$	K	$0.50 \pm 0.20 \text{ mm}$	S	$0.80 \pm 0.07 \text{ mm}$
D	$1.40 \pm 0.15 \text{ mm}$	L	$0.30 \pm 0.03 \text{ mm}$	T	$0.85 \pm 0.10 \text{ mm}$
E	$1.60 \pm 0.20 \text{ mm}$	M	$0.95 \pm 0.10 \text{ mm}$	U	$0.50 \pm 0.10 \text{ mm}$
F	$2.00 \pm 0.20 \text{ mm}$	N	$0.50 \pm 0.05 \text{ mm}$	V	$0.20 \pm 0.02 \text{ mm}$
G	$2.50 \pm 0.30 \text{ mm}$	O	$3.50 \pm 0.20 \text{ mm}$	X	$0.80 \pm 0.10 \text{ mm}$
H	$2.80 \pm 0.30 \text{ mm}$	P	$1.60 +0.3/-0.10 \text{ mm}$	Z	$0.25 \pm 0.03 \text{ mm}$

Table 9		Special Control Code	
Code	Description		
G	RoHS Compliant		
O	Gold plating (Size $\geq$ 0603)		

## 5. EXTERNAL DIMENSIONS

Size Inch (mm)	L (mm)	W (mm)	Code / T (mm)	M <sub>B</sub> (mm)
0201(0603)	0.60±0.03	0.30±0.03	See No.4 Reference Table 8	0.15±0.05
0402(1005)	1.00±0.10	0.50±0.10		0.25 +0.05/-0.10
0603(1608)	1.60±0.15	0.80±0.15		0.40±0.15
0805(2012)	2.00±0.20	1.25±0.20		0.50±0.20
1206(3216)	3.20±0.20	1.60±0.20		0.60±0.20
1210(3225)	3.20±0.30	2.50±0.30		0.75±0.35
1812(4532)	4.50±0.40	3.20±0.30		0.75±0.35
1825(4563)	4.50±0.40	6.30±0.40		0.75±0.35
2220(5750)	5.70±0.40	5.00±0.40		0.85±0.35
2225(5763)	5.70±0.40	6.30±0.40		0.85±0.35

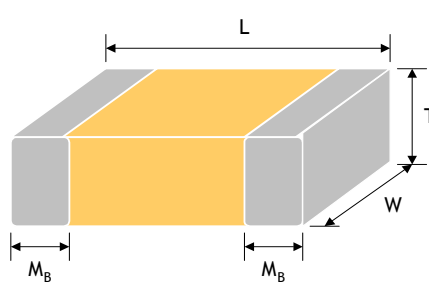

Fig. 5.1 The outline of MLCC

## 6. GENERAL ELECTRICAL DATA

Dielectric	X7R	X6S	X5R	Y5V
Size	0402, 0603, 0805, 1206, 1210, 1812, 1825, 2220, 2225	0201, 0402, 0603, 0805, 1206, 1210	0201, 0402, 0603, 0805, 1206, 1210	0402, 0603, 0805, 1206, 1210, 1812
Rated voltage (WVDC)	6.3V, 10V, 16V, 25V, 50V, 100V, 250V, 500V, 630V	6.3V, 10V, 16V, 25V, 35V, 50V	4V, 6.3V, 10V, 16V, 25V, 35V, 50V	6.3V, 10V, 16V, 25V, 35V, 50V, 100V
Capacitance range*	1μF to 47μF	1μF to 100μF	1μF to 220μF	1μF to 100μF
Capacitance tolerance	K (±10%), M(±20%)			Z (-20/+80%)
Tan δ	Note 1			
Operating temperature	-55 to +125°C	-55 to +105°C	-55 to +85°C	-25 to +85 °C
Capacitance characteristic	±15%	±22%	±15%	+30/-80%
Termination	Cu or Ag/Ni/Sn or Au (lead-free termination)			

\* Measured at 1.0±0.2Vrms, 1.0KHz±10% for Cap.≤10μF; 0.5±0.2Vrms, 120Hz±20% for Cap.>10μF, 30~70% related humidity, 25°C ambient temperature for X7R, X5R and at 20°C for Y5V.

\*\* Preconditioning for Class II MLCC : Perform a heat treatment at 150±10°C for 1 hour, then leave in ambient condition for 24±2 hours before measurement.

Note 1 : X7R/X5R/X6S/X7S

Y5V

Rated	D.F.≤	Exception of D.F.≤	
≥100V	≤2.5%	≤3%	1206≥0.47μF
		≤5%	0805>0.1μF, 0603≥0.068μF, 1206>1μF, 1210≥2.2μF
		≤10%	0805>0.22μF, 1210≥3.3μF
50V	≤2.5%	≤3%	0201(50V), 0603≥0.047μF, 0805≥0.18μF, 1206≥0.47μF, 1812≥10μF, 2220≥22μF
		≤5%	0201≥0.01μF, 1210≥4.7μF
		≤10%	0402≥0.1μF, 0603>0.1μF, 0805≥1μF, 1206≥2.2μF, 1210≥10μF
35V	≤3.5%	≤10%	0603≥1μF, 0805≥2.2μF, 1206≥2.2μF, 1210≥10μF
25V	≤3.5%	≤5%	0201≥0.01μF, 0805≥1μF, 1210≥10μF
		≤7%	0603≥0.33μF, 1206≥4.7μF
		≤10%	0201≥0.1μF, 0402≥0.10μF, 0603≥0.47μF, 0805≥2.2μF, 1206≥6.8μF, 1210≥22μF
	≤12.5%	0402≥0.47μF	
16V	≤3.5%	≤5%	0201≥0.01μF, 0402≥0.033μF, 0603≥0.15μF, 0805≥0.68μF, 1206≥2.2μF, 1210≥4.7μF
		≤10%	0201≥0.1μF(0201/X7R≥0.022μF), 0402≥0.22μF, 0603≥0.68μF, 0805≥2.2μF, 1206≥4.7μF, 1210≥22μF
10V	≤5%	≤10%	0201≥0.012μF, 0402≥0.33μF(0402/X7R≥0.22μF), 0603≥0.33μF, 0805≥2.2μF, 1206≥2.2μF, 1210≥22μF
		≤15%	0201≥0.1μF, 0402≥1μF
6.3V	≤10%	≤15%	0201≥0.1μF, 0402≥1μF, 0603≥10μF, 0805≥4.7μF, 1206≥47μF, 1210≥100μF
		≤20%	0402≥2.2μF
4V	≤15%	---	---

Rated	D.F.≤	Exception of D.F.≤	
≥50V	≤5%	≤7%	0603≥0.1μF, 0805≥0.47μF, 1206≥4.7μF
		≤12.5%	1210≥6.8μF
35V	≤7%	---	---
25V	≤5%	≤7%	0402≥0.047μF, 0603≥0.1μF, 0805≥0.33μF, 1206≥1μF, 1210≥4.7μF
		≤9%	0402≥0.068μF, 0603≥0.47μF, 1206≥4.7μF, 1210≥22μF
16V (C<1.0μF)	≤7%	≤9%	0402≥0.068μF, 0603≥0.68μF
		≤12.5%	0402≥0.22μF
16V (C≥1.0μF)	≤9%	≤12.5%	0603≥2.2μF, 0805≥3.3μF, 1206≥10μF, 1210≥22μF, 1812≥47μF
10V	≤12.5%	≤20%	0402≥0.47μF
6.3V	≤20%	---	---

# 7. CAPACITANCE RANGE

## 7-1. X7R

Dimension		0402						0603					0805					1206					
Cap(pF)	code	16V	6.3V	10V	16V	25V	50V	6.3V	10V	16V	25V	50V	6.3V	10V	16V	25V	50V	100V					
1000000	105	N	B	B	B	B	B		C	C	C	I		J	J	J	P	P	P				
1200000	125																P	P	P				
1500000	155								I	I	I		J	J	J	P	P						
1800000	185															P	P						
2200000	225		B	B	B			I	I	I	I	I	J	J	J	P	P	P					
2700000	275																						
3300000	335													P	P	P	P						
3900000	395																						
4700000	475		B					I	I	I	I		P	P	P	P	P						
5600000	565																						
6800000	685																						
8200000	825																						
10000000	106							I	I	I*			P	P	P	P							
12000000	126																						
15000000	156																						
18000000	186																						
22000000	226												P	P	P*								
47000000	476																						

Dimension		1210						1812						1825					
Cap(pF)	code	6.3V	10V	16V	25V	50V	100V	10V	16V	25V	50V	100V	200V	250V	25V	50V	100V	200V	250V
1000000	105		C	C	C	C	F	C	C	C	F	F	G	G	G	F	F	F	F
1200000	125					G	G			C	F	F				F	F	G	G
1500000	155			E	E	G	G			C	F	F				F	F	G	G
1800000	185					G	G			E	F	F				F	F	G	G
2200000	225		E	E	E	G	G			E	F	G				F	F	G	G
2700000	275					G	G			F	F	G				F	F	H	H
3300000	335		E	E	E	G	G			F	F	G				F	F		
3900000	395									F	F	G				F	F		
4700000	475		F	F	F	G	G			G	G	G				F	G		
5600000	565									G	G	G				G	G		
6800000	685									G	G					G	G		
8200000	825									G	G					G	G		
10000000	106		F	F	F	G				G	G					G	G		
12000000	126																		
15000000	156																		
18000000	186																		
22000000	226		G	G	G														
47000000	476	G	G																

Dimension		2220						2225							
Cap(pF)	code	25V	50V	100V	200V	250V	500V	630V	25V	50V	100V	200V	250V	500V	630V
1000000	105	F	F	F	F	F	H	H	F	F	F	F	F	G	G
1200000	125	F	F	F	G	G			F	F	F	G	G	H	H
1500000	155	F	F	F	G	G			F	F	F	G	G	H	H
1800000	185	F	F	F	G	G			F	F	F	G	G		
2200000	225	F	F	F	G	G			F	F	F	G	G		
2700000	275	F	F	F	H	H			F	F	F	G	G		
3300000	335	F	F	F					F	F	F	H	H		
3900000	395	F	F	F					F	F	F	H	H		
4700000	475	F	F	F					F	F	G				
5600000	565	F	F	F					F	F	G				
6800000	685	F	F	F					F	F	G				
8200000	825	G	G	G					G	G	G				
10000000	106	G	G	G					G	G	G				
12000000	126	H							H						
15000000	156	H							H						
18000000	186	H							H						
22000000	226	H	H						H	H					
47000000	476														

## 7. CAPACITANCE RANGE(Con.)

### 7-2. X5R

Dimension		0201			0402				0603						
Cap(pF)	code	6.3V	10V	16V	4V	6.3V	10V	16V	25V	4V	6.3V	10V	16V	25V	50V
1000000	105	L	L	L		N	N	N	N		B	B	B	B	B
1500000	155										B				
2200000	225	L				N	N	K	K		B	B	B	B	B
3300000	335										B	B			
4700000	475					K	K	K			B	B	B	B	
6800000	685														
10000000	106				K	K	K			B	B	B	B	B	
22000000	226									B	B	B			
47000000	476									B	B				
100000000	107														
220000000	227														

Dimension		0805					1206						
Cap(pF)	code	4V	6.3V	10V	16V	25V	50V	4V	6.3V	10V	16V	25V	50V
1000000	105			C	C	C	I						P
1500000	155		I	I	I	I				J	J		
2200000	225		I	I	I	I	I			J	J	P	P
3300000	335		I	I	I	I				P	P	P	
4700000	475		I	I	I	I	I		P	P	P	P	P
6800000	685								P	P			
10000000	106		I	I	I	I	I		P	P	P	P	P
22000000	226		I	I	I	I			P	P	P	P	
47000000	476		I	I					P	P	P		
100000000	107	I	I						P				
220000000	227							P					

Dimension		1210						
Cap(pF)	code	4V	6.3V	10V	16V	25V	35V	50V
1000000	105							
1500000	155			F	F			
2200000	225			F	F			
3300000	335							
4700000	475			F	F	F		
6800000	685							
10000000	106		F	F	F	F	G	G
22000000	226		G	G	G	G	G	
47000000	476		G	G	G	G		
100000000	107		G	G	G			
220000000	227	G	G					

## 7. CAPACITANCE RANGE(Con.)

### 7-3. Y5V

Dimension		0402		0603				0805					1206					
Cap(pF)	code	6.3V	10V	6.3V	10V	16V	25V	6.3V	10V	16V	25V	50V	6.3V	10V	16V	25V	35V	50V
1000000	105	N	N		S	B	B		X	X	C	C		M	M	M		M
1500000	155				S				C	C				M	M	M		
2200000	225			S	S	B			C	C	I	I		M	M	M		J
3300000	335								C	C				J	J	J		
4700000	475			B	B				C	C	I			J	J	J	J	P
6800000	685								I					J	J			
10000000	106							I	I	I				J	J	P		
22000000	226							I	I					P	P			
47000000	476												P					
100000000	107																	
220000000	227																	

Dimension		1210						1812				
Cap(pF)	code	6.3V	10V	16V	25V	35V	50V	10V	16V	25V	50V	100V
1000000	105		M	M	M		M	C	C	C	C	C
1500000	155		M	M	M			C	C	C	C	C
2200000	225		M	M	M		E	C	C	C	C	C
3300000	335		M	M	M			C	C	C	C	C
4700000	475		M	M	C		E	C	C	C	C	C
6800000	685		M	M	C		F	C	C	C	C	C
10000000	106		C	C	E	F	F	C	C	C	F	
22000000	226		F	F								
47000000	476	F	F					G				
100000000	107	G										
220000000	227											

### 7-4. X6S

Dimension		0201		0402				0603					0805					
Cap(pF)	code	4V	6.3V	6.3V	10V	16V	25V	4V	6.3V	10V	16V	25V	4V	6.3V	10V	16V	25V	50V
1000000	105	L	L*	K	K	K	K											
1500000	155																	
2200000	225			K	K	K					B	B						
3300000	335																	
4700000	475				K*				B		B	B					I	I
6800000	685																	
10000000	106			K*					B*	B*	B*		I	I	I	I	I	
22000000	226							B*	B*					I*	I*	I*	I*	
47000000	476												I*	I*				
100000000	107												I*					
220000000	227																	

Dimension		1206				1210			
Cap(pF)	code	6.3V	10V	16V	25V	6.3V	10V	16V	25V
1000000	105								
1500000	155								
2200000	225								
3300000	335								
4700000	475								
6800000	685								
10000000	106				P				
22000000	226		P	P*	P				G
47000000	476	p				G	G	G	
100000000	107					G*	G*		
220000000	227								

\*\*\*) Means M tolerance only.

## 8. RELIABILITY TEST CONDITIONS AND REQUIREMENTS

No.	Item	Test Condition	Requirements																																																																																												
1.	Visual and Dimensions	---	* No remarkable defect. * Dimensions to confirm to individual specification sheet.																																																																																												
2.	Capacitance		* Shall not exceed the limits given in the detailed spec. X7R, X5R, X6S																																																																																												
3.	Q/D.F. (Dissipation Factor)	<p>* Class II : (X7R, X6S, X5R, Y5V) Cap.≤10μF, 1.0±0.2Vrms, 1KHz±10%**. Cap.&gt;10μF, 0.5±0.2Vrms, 120Hz±20%.</p> <p>** Test condition : 0.5±0.2Vrms, 1KHz±10%. X7R : 0805=106(6.3V&amp;10V), 0603=475(6.3V). X6S : 0201≥104(6.3V&amp;10V),0402≥225(6.3V), 0402/475(10V), 0603/106(6.3V). X5R : 01R5≥103, 0201≥224(6.3V,10V,16V)<sup>#1</sup>, 0402≥475(6.3V,16V), 0402≥225(10V), 0603=106(6.3V,10V).</p>	<table border="1"> <thead> <tr> <th>Rated</th> <th>D.F.≤</th> <th colspan="2">Exception of D.F.≤</th> </tr> </thead> <tbody> <tr> <td rowspan="3">≥100V</td> <td rowspan="3">≤2.5%</td> <td>≤3%</td> <td>1206≥0.47μF</td> </tr> <tr> <td>≤5%</td> <td>0805&gt;0.1μF, 0603≥0.068μF, 1206&gt;1μF, 1210≥2.2μF</td> </tr> <tr> <td>≤10%</td> <td>0805&gt;0.22μF, 1210≥3.3μF</td> </tr> <tr> <td rowspan="3">50V</td> <td rowspan="3">≤2.5%</td> <td>≤3%</td> <td>0201(50V), 0603≥0.047μF, 0805≥0.18μF, 1206≥0.47μF, 1812≥10μF, 2220≥22μF</td> </tr> <tr> <td>≤5%</td> <td>0201≥0.01μF, 1210≥4.7μF</td> </tr> <tr> <td>≤10%</td> <td>0402≥0.1μF, 0603&gt;0.1μF, 0805≥1μF, 1206≥2.2μF, 1210≥10μF</td> </tr> <tr> <td>35V</td> <td>≤3.5%</td> <td>≤10%</td> <td>0603≥1μF, 0805≥2.2μF, 1206≥2.2μF, 1210≥10μF</td> </tr> <tr> <td rowspan="3">25V</td> <td rowspan="3">≤3.5%</td> <td>≤5%</td> <td>0201≥0.01μF, 0805≥1μF, 1210≥10μF</td> </tr> <tr> <td>≤7%</td> <td>0603≥0.33μF, 1206≥4.7μF</td> </tr> <tr> <td>≤10%</td> <td>0201≥0.1μF, 0402≥0.10μF, 0603≥0.47μF, 0805≥2.2μF, 1206≥6.8μF, 1210≥22μF</td> </tr> <tr> <td rowspan="2">16V</td> <td rowspan="2">≤3.5%</td> <td>≤5%</td> <td>0201≥0.01μF, 0402≥0.033μF, 0603≥0.15μF, 0805≥0.68μF, 1206≥2.2μF, 1210≥4.7μF</td> </tr> <tr> <td>≤10%</td> <td>0201≥0.1μF(0201/X7R≥0.022μF), 0402≥0.22μF, 0603≥0.68μF, 0805≥2.2μF, 1206≥4.7μF, 1210≥22μF</td> </tr> <tr> <td rowspan="2">10V</td> <td rowspan="2">≤5%</td> <td>≤10%</td> <td>0201≥0.012μF, 0402≥0.33μF(0402/X7R≥0.22μF), 0603≥0.33μF, 0805≥2.2μF, 1206≥2.2μF, 1210≥22μF</td> </tr> <tr> <td>≤15%</td> <td>0201≥0.1μF, 0402≥1μF</td> </tr> <tr> <td>6.3V</td> <td>≤10%</td> <td>≤15%</td> <td>0201≥0.1μF, 0402≥1μF, 0603≥10μF, 0805≥4.7μF, 1206≥47μF, 1210≥100μF</td> </tr> <tr> <td>4V</td> <td>≤15%</td> <td>---</td> <td>---</td> </tr> </tbody> </table> <table border="1"> <thead> <tr> <th>Rated Vol.</th> <th>D.F.≤</th> <th colspan="2">Exception of D.F.≤</th> </tr> </thead> <tbody> <tr> <td rowspan="2">≥50V</td> <td rowspan="2">≤5%</td> <td>≤7%</td> <td>0603≥0.1μF, 0805≥0.47μF, 1206≥4.7μF</td> </tr> <tr> <td>≤12.5%</td> <td>1210≥6.8μF</td> </tr> <tr> <td>35V</td> <td>≤7%</td> <td>---</td> <td>---</td> </tr> <tr> <td rowspan="2">25V</td> <td rowspan="2">≤5%</td> <td>≤7%</td> <td>0402≥0.047μF, 0603≥0.1μF, 0805≥0.33μF, 1206≥1μF, 1210≥4.7μF</td> </tr> <tr> <td>≤9%</td> <td>0402≥0.068μF, 0603≥0.47μF, 1206≥4.7μF, 1210≥22μF</td> </tr> <tr> <td rowspan="2">16V (C&lt;1.0μF)</td> <td rowspan="2">≤7%</td> <td>≤9%</td> <td>0402≥0.068μF, 0603≥0.68μF</td> </tr> <tr> <td>≤12.5%</td> <td>0402≥0.22μF</td> </tr> <tr> <td rowspan="2">16V (C≥1.0μF)</td> <td rowspan="2">≤9%</td> <td>≤12.5%</td> <td>0603≥2.2μF, 0805≥3.3μF, 1206≥10μF, 1210≥22μF, 1812≥47μF</td> </tr> <tr> <td>≤20%</td> <td>0402≥0.47μF</td> </tr> <tr> <td>10V</td> <td>≤12.5%</td> <td>≤20%</td> <td>0402≥0.47μF</td> </tr> <tr> <td>6.3V</td> <td>≤20%</td> <td>---</td> <td>---</td> </tr> </tbody> </table>	Rated	D.F.≤	Exception of D.F.≤		≥100V	≤2.5%	≤3%	1206≥0.47μF	≤5%	0805>0.1μF, 0603≥0.068μF, 1206>1μF, 1210≥2.2μF	≤10%	0805>0.22μF, 1210≥3.3μF	50V	≤2.5%	≤3%	0201(50V), 0603≥0.047μF, 0805≥0.18μF, 1206≥0.47μF, 1812≥10μF, 2220≥22μF	≤5%	0201≥0.01μF, 1210≥4.7μF	≤10%	0402≥0.1μF, 0603>0.1μF, 0805≥1μF, 1206≥2.2μF, 1210≥10μF	35V	≤3.5%	≤10%	0603≥1μF, 0805≥2.2μF, 1206≥2.2μF, 1210≥10μF	25V	≤3.5%	≤5%	0201≥0.01μF, 0805≥1μF, 1210≥10μF	≤7%	0603≥0.33μF, 1206≥4.7μF	≤10%	0201≥0.1μF, 0402≥0.10μF, 0603≥0.47μF, 0805≥2.2μF, 1206≥6.8μF, 1210≥22μF	16V	≤3.5%	≤5%	0201≥0.01μF, 0402≥0.033μF, 0603≥0.15μF, 0805≥0.68μF, 1206≥2.2μF, 1210≥4.7μF	≤10%	0201≥0.1μF(0201/X7R≥0.022μF), 0402≥0.22μF, 0603≥0.68μF, 0805≥2.2μF, 1206≥4.7μF, 1210≥22μF	10V	≤5%	≤10%	0201≥0.012μF, 0402≥0.33μF(0402/X7R≥0.22μF), 0603≥0.33μF, 0805≥2.2μF, 1206≥2.2μF, 1210≥22μF	≤15%	0201≥0.1μF, 0402≥1μF	6.3V	≤10%	≤15%	0201≥0.1μF, 0402≥1μF, 0603≥10μF, 0805≥4.7μF, 1206≥47μF, 1210≥100μF	4V	≤15%	---	---	Rated Vol.	D.F.≤	Exception of D.F.≤		≥50V	≤5%	≤7%	0603≥0.1μF, 0805≥0.47μF, 1206≥4.7μF	≤12.5%	1210≥6.8μF	35V	≤7%	---	---	25V	≤5%	≤7%	0402≥0.047μF, 0603≥0.1μF, 0805≥0.33μF, 1206≥1μF, 1210≥4.7μF	≤9%	0402≥0.068μF, 0603≥0.47μF, 1206≥4.7μF, 1210≥22μF	16V (C<1.0μF)	≤7%	≤9%	0402≥0.068μF, 0603≥0.68μF	≤12.5%	0402≥0.22μF	16V (C≥1.0μF)	≤9%	≤12.5%	0603≥2.2μF, 0805≥3.3μF, 1206≥10μF, 1210≥22μF, 1812≥47μF	≤20%	0402≥0.47μF	10V	≤12.5%	≤20%	0402≥0.47μF	6.3V	≤20%	---	---
			Rated	D.F.≤	Exception of D.F.≤																																																																																										
≥100V	≤2.5%	≤3%	1206≥0.47μF																																																																																												
		≤5%	0805>0.1μF, 0603≥0.068μF, 1206>1μF, 1210≥2.2μF																																																																																												
		≤10%	0805>0.22μF, 1210≥3.3μF																																																																																												
50V	≤2.5%	≤3%	0201(50V), 0603≥0.047μF, 0805≥0.18μF, 1206≥0.47μF, 1812≥10μF, 2220≥22μF																																																																																												
		≤5%	0201≥0.01μF, 1210≥4.7μF																																																																																												
		≤10%	0402≥0.1μF, 0603>0.1μF, 0805≥1μF, 1206≥2.2μF, 1210≥10μF																																																																																												
35V	≤3.5%	≤10%	0603≥1μF, 0805≥2.2μF, 1206≥2.2μF, 1210≥10μF																																																																																												
25V	≤3.5%	≤5%	0201≥0.01μF, 0805≥1μF, 1210≥10μF																																																																																												
		≤7%	0603≥0.33μF, 1206≥4.7μF																																																																																												
		≤10%	0201≥0.1μF, 0402≥0.10μF, 0603≥0.47μF, 0805≥2.2μF, 1206≥6.8μF, 1210≥22μF																																																																																												
16V	≤3.5%	≤5%	0201≥0.01μF, 0402≥0.033μF, 0603≥0.15μF, 0805≥0.68μF, 1206≥2.2μF, 1210≥4.7μF																																																																																												
		≤10%	0201≥0.1μF(0201/X7R≥0.022μF), 0402≥0.22μF, 0603≥0.68μF, 0805≥2.2μF, 1206≥4.7μF, 1210≥22μF																																																																																												
10V	≤5%	≤10%	0201≥0.012μF, 0402≥0.33μF(0402/X7R≥0.22μF), 0603≥0.33μF, 0805≥2.2μF, 1206≥2.2μF, 1210≥22μF																																																																																												
		≤15%	0201≥0.1μF, 0402≥1μF																																																																																												
6.3V	≤10%	≤15%	0201≥0.1μF, 0402≥1μF, 0603≥10μF, 0805≥4.7μF, 1206≥47μF, 1210≥100μF																																																																																												
4V	≤15%	---	---																																																																																												
Rated Vol.	D.F.≤	Exception of D.F.≤																																																																																													
≥50V	≤5%	≤7%	0603≥0.1μF, 0805≥0.47μF, 1206≥4.7μF																																																																																												
		≤12.5%	1210≥6.8μF																																																																																												
35V	≤7%	---	---																																																																																												
25V	≤5%	≤7%	0402≥0.047μF, 0603≥0.1μF, 0805≥0.33μF, 1206≥1μF, 1210≥4.7μF																																																																																												
		≤9%	0402≥0.068μF, 0603≥0.47μF, 1206≥4.7μF, 1210≥22μF																																																																																												
16V (C<1.0μF)	≤7%	≤9%	0402≥0.068μF, 0603≥0.68μF																																																																																												
		≤12.5%	0402≥0.22μF																																																																																												
16V (C≥1.0μF)	≤9%	≤12.5%	0603≥2.2μF, 0805≥3.3μF, 1206≥10μF, 1210≥22μF, 1812≥47μF																																																																																												
		≤20%	0402≥0.47μF																																																																																												
10V	≤12.5%	≤20%	0402≥0.47μF																																																																																												
6.3V	≤20%	---	---																																																																																												
4.	Temperature Coefficient	<p>* With no electrical load.</p> <table border="1"> <thead> <tr> <th>T.C.</th> <th>Operating Temp.</th> </tr> </thead> <tbody> <tr> <td>X7R</td> <td>-55~125°C at 25°C</td> </tr> <tr> <td>X6S</td> <td>-55~105°C at 25°C</td> </tr> <tr> <td>X5R</td> <td>-55~ 85°C at 25°C</td> </tr> <tr> <td>Y5V</td> <td>-25~ 85°C at 20°C</td> </tr> </tbody> </table> <p>* Measurement voltage for Class II :</p> <table border="1"> <thead> <tr> <th>Size</th> <th>Cap. Range</th> <th>Condition</th> </tr> </thead> <tbody> <tr> <td rowspan="3">0201</td> <td>Cap.&lt;0.1μF</td> <td>1V</td> </tr> <tr> <td>0.1μF≤Cap.&lt;1μF</td> <td>0.2V</td> </tr> <tr> <td>Cap.≥1μF</td> <td>0.1V</td> </tr> <tr> <td rowspan="3">0402</td> <td>Cap.&lt;0.1μF</td> <td>1V</td> </tr> <tr> <td>Cap.=1μF</td> <td>0.5V</td> </tr> <tr> <td>1μF&lt;Cap.&lt;10μF</td> <td>0.2V</td> </tr> <tr> <td rowspan="3">0603</td> <td>Cap.≥10μF</td> <td>0.1V</td> </tr> <tr> <td>Cap.≤1μF</td> <td>1V</td> </tr> <tr> <td>1μF&lt;Cap.≤4.7μF</td> <td>0.5V</td> </tr> <tr> <td rowspan="3">0805</td> <td>Cap.&gt;4.7μF</td> <td>0.2V</td> </tr> <tr> <td>Cap.&lt;10μF</td> <td>1V</td> </tr> <tr> <td>Cap.=10μF</td> <td>0.5V</td> </tr> <tr> <td rowspan="3">1206/1210</td> <td>Cap.&gt;10μF</td> <td>0.2V</td> </tr> <tr> <td>Cap.≤10μF</td> <td>1V</td> </tr> <tr> <td>10μF&lt;Cap.≤100μF</td> <td>0.5V</td> </tr> <tr> <td></td> <td>Cap.&gt;100μF</td> <td>0.2V</td> </tr> </tbody> </table>	T.C.	Operating Temp.	X7R	-55~125°C at 25°C	X6S	-55~105°C at 25°C	X5R	-55~ 85°C at 25°C	Y5V	-25~ 85°C at 20°C	Size	Cap. Range	Condition	0201	Cap.<0.1μF	1V	0.1μF≤Cap.<1μF	0.2V	Cap.≥1μF	0.1V	0402	Cap.<0.1μF	1V	Cap.=1μF	0.5V	1μF<Cap.<10μF	0.2V	0603	Cap.≥10μF	0.1V	Cap.≤1μF	1V	1μF<Cap.≤4.7μF	0.5V	0805	Cap.>4.7μF	0.2V	Cap.<10μF	1V	Cap.=10μF	0.5V	1206/1210	Cap.>10μF	0.2V	Cap.≤10μF	1V	10μF<Cap.≤100μF	0.5V		Cap.>100μF	0.2V	<table border="1"> <thead> <tr> <th>T.C.</th> <th>Capacitance Change</th> </tr> </thead> <tbody> <tr> <td>X7R</td> <td>Within ±15%</td> </tr> <tr> <td>X6S</td> <td>Within ±22%</td> </tr> <tr> <td>X5R</td> <td>Within ±15%</td> </tr> <tr> <td>Y5V</td> <td>Within +30%/-80%</td> </tr> </tbody> </table>	T.C.	Capacitance Change	X7R	Within ±15%	X6S	Within ±22%	X5R	Within ±15%	Y5V	Within +30%/-80%																															
T.C.	Operating Temp.																																																																																														
X7R	-55~125°C at 25°C																																																																																														
X6S	-55~105°C at 25°C																																																																																														
X5R	-55~ 85°C at 25°C																																																																																														
Y5V	-25~ 85°C at 20°C																																																																																														
Size	Cap. Range	Condition																																																																																													
0201	Cap.<0.1μF	1V																																																																																													
	0.1μF≤Cap.<1μF	0.2V																																																																																													
	Cap.≥1μF	0.1V																																																																																													
0402	Cap.<0.1μF	1V																																																																																													
	Cap.=1μF	0.5V																																																																																													
	1μF<Cap.<10μF	0.2V																																																																																													
0603	Cap.≥10μF	0.1V																																																																																													
	Cap.≤1μF	1V																																																																																													
	1μF<Cap.≤4.7μF	0.5V																																																																																													
0805	Cap.>4.7μF	0.2V																																																																																													
	Cap.<10μF	1V																																																																																													
	Cap.=10μF	0.5V																																																																																													
1206/1210	Cap.>10μF	0.2V																																																																																													
	Cap.≤10μF	1V																																																																																													
	10μF<Cap.≤100μF	0.5V																																																																																													
	Cap.>100μF	0.2V																																																																																													
T.C.	Capacitance Change																																																																																														
X7R	Within ±15%																																																																																														
X6S	Within ±22%																																																																																														
X5R	Within ±15%																																																																																														
Y5V	Within +30%/-80%																																																																																														



## 8. RELIABILITY TEST CONDITIONS AND REQUIREMENTS

No.	Item	Test Condition	Requirements																					
5.	Insulation Resistance	<p>* To apply rated voltage for Max. 120sec.</p> <p>* Before initial measurement (Class II only) : To apply de-aging at 150°C for 1hr then set for 24±2 hrs at room temp.</p>	<p>* ≥10GΩ or RxC≥500Ω-F, whichever is smaller.</p> <p>* Class II (X7R, X5R, X6S, Y5V) :</p> <table border="1"> <thead> <tr> <th>Rated voltage</th> <th>I.R.</th> </tr> </thead> <tbody> <tr> <td>100V : All X7R</td> <td rowspan="5">≥10GΩ or RxC≥100Ω-F, whichever is smaller</td> </tr> <tr> <td>50V : 0402&gt;0.01μF, 0603≥1μF, 0805≥1μF, 1206≥4.7μF, 1210≥4.7μF</td> </tr> <tr> <td>35V : 0805≥2.2μF, 1206≥2.2μF, 1210≥10μF</td> </tr> <tr> <td>25V : 0402≥1μF, 0603≥2.2μF, 0805≥2.2μF, 1206≥10μF, 1210≥10μF</td> </tr> <tr> <td>16V : 0201≥0.1μF, 0402≥0.22μF, 0603≥1μF, 0805≥2.2μF, 1206≥10μF, 1210≥47μF</td> </tr> <tr> <td>10V : 0201≥47nF, 0402≥0.47μF, 0603≥0.47μF, 0805≥2.2μF, 1206≥4.7μF, 1210≥47μF</td> <td rowspan="5">RxC≥50Ω-F</td> </tr> <tr> <td>6.3V, 4V</td> </tr> <tr> <td>Rated voltage</td> </tr> <tr> <td>100V : 1210≥3.3μF</td> </tr> <tr> <td>50V : 0402≥0.1μF, 0603≥2.2μF, 0805≥10μF, 1206≥10μF</td> </tr> <tr> <td>35V : 0603≥1μF</td> <td rowspan="5">RxC≥50Ω-F</td> </tr> <tr> <td>25V : 0201≥0.1μF, 0402≥2.2μF, 0603≥10μF, 0805≥10μF, 1206≥22μF</td> </tr> <tr> <td>16V : 0603≥10μF, 0402≥1μF, 0201≥0.22μF</td> </tr> <tr> <td>10V : 0201&gt;0.1μF, 0402≥1μF, 0603≥10μF, 0805≥47μF</td> </tr> <tr> <td>6.3V : 0201≥0.1μF, 0603&gt;4.7μF, 0805≥47μF, 1206≥10μF</td> </tr> <tr> <td>4V : 0603≥22μF, 0805≥47μF, 1206≥100μF</td> </tr> </tbody> </table>	Rated voltage	I.R.	100V : All X7R	≥10GΩ or RxC≥100Ω-F, whichever is smaller	50V : 0402>0.01μF, 0603≥1μF, 0805≥1μF, 1206≥4.7μF, 1210≥4.7μF	35V : 0805≥2.2μF, 1206≥2.2μF, 1210≥10μF	25V : 0402≥1μF, 0603≥2.2μF, 0805≥2.2μF, 1206≥10μF, 1210≥10μF	16V : 0201≥0.1μF, 0402≥0.22μF, 0603≥1μF, 0805≥2.2μF, 1206≥10μF, 1210≥47μF	10V : 0201≥47nF, 0402≥0.47μF, 0603≥0.47μF, 0805≥2.2μF, 1206≥4.7μF, 1210≥47μF	RxC≥50Ω-F	6.3V, 4V	Rated voltage	100V : 1210≥3.3μF	50V : 0402≥0.1μF, 0603≥2.2μF, 0805≥10μF, 1206≥10μF	35V : 0603≥1μF	RxC≥50Ω-F	25V : 0201≥0.1μF, 0402≥2.2μF, 0603≥10μF, 0805≥10μF, 1206≥22μF	16V : 0603≥10μF, 0402≥1μF, 0201≥0.22μF	10V : 0201>0.1μF, 0402≥1μF, 0603≥10μF, 0805≥47μF	6.3V : 0201≥0.1μF, 0603>4.7μF, 0805≥47μF, 1206≥10μF	4V : 0603≥22μF, 0805≥47μF, 1206≥100μF
Rated voltage	I.R.																							
100V : All X7R	≥10GΩ or RxC≥100Ω-F, whichever is smaller																							
50V : 0402>0.01μF, 0603≥1μF, 0805≥1μF, 1206≥4.7μF, 1210≥4.7μF																								
35V : 0805≥2.2μF, 1206≥2.2μF, 1210≥10μF																								
25V : 0402≥1μF, 0603≥2.2μF, 0805≥2.2μF, 1206≥10μF, 1210≥10μF																								
16V : 0201≥0.1μF, 0402≥0.22μF, 0603≥1μF, 0805≥2.2μF, 1206≥10μF, 1210≥47μF																								
10V : 0201≥47nF, 0402≥0.47μF, 0603≥0.47μF, 0805≥2.2μF, 1206≥4.7μF, 1210≥47μF	RxC≥50Ω-F																							
6.3V, 4V																								
Rated voltage																								
100V : 1210≥3.3μF																								
50V : 0402≥0.1μF, 0603≥2.2μF, 0805≥10μF, 1206≥10μF																								
35V : 0603≥1μF	RxC≥50Ω-F																							
25V : 0201≥0.1μF, 0402≥2.2μF, 0603≥10μF, 0805≥10μF, 1206≥22μF																								
16V : 0603≥10μF, 0402≥1μF, 0201≥0.22μF																								
10V : 0201>0.1μF, 0402≥1μF, 0603≥10μF, 0805≥47μF																								
6.3V : 0201≥0.1μF, 0603>4.7μF, 0805≥47μF, 1206≥10μF																								
4V : 0603≥22μF, 0805≥47μF, 1206≥100μF																								
6.	Dielectric Strength	<table border="1"> <thead> <tr> <th>Rated Voltage</th> <th>Condition</th> </tr> </thead> <tbody> <tr> <td>≤100</td> <td>2.5 times of U<sub>R</sub></td> </tr> <tr> <td>100&lt;V≤250</td> <td>2.0 times of U<sub>R</sub></td> </tr> <tr> <td>250&lt;V≤500</td> <td>1.5 times of U<sub>R</sub></td> </tr> <tr> <td>630</td> <td>1.2 times of U<sub>R</sub></td> </tr> </tbody> </table> <p>* Duration : 1 to 5 sec.</p> <p>* Charge and discharge current less than 50mA.</p>	Rated Voltage	Condition	≤100	2.5 times of U <sub>R</sub>	100<V≤250	2.0 times of U <sub>R</sub>	250<V≤500	1.5 times of U <sub>R</sub>	630	1.2 times of U <sub>R</sub>	<p>* No evidence of damage or flash over during test.</p>											
Rated Voltage	Condition																							
≤100	2.5 times of U <sub>R</sub>																							
100<V≤250	2.0 times of U <sub>R</sub>																							
250<V≤500	1.5 times of U <sub>R</sub>																							
630	1.2 times of U <sub>R</sub>																							
7.	Solderability	<p>* Solder temperature : 235±5°C for (0201~1210).</p> <p>* Solder temperature : 245±5°C for (1808~2225).</p> <p>* Dipping time : 2±0.5 sec.</p>	<p>* 75% min. coverage of all metalized area.</p>																					
8.	Resistance to Soldering Heat	<p>* Solder temperature : 260±5°C.</p> <p>* Dipping time : 10±1 sec.</p> <p>* Preheating : 120 to 150°C for 1 minute before immerse the capacitor in a eutectic solder.</p> <p>* Before initial measurement (Class II only) : To apply de-aging at 150°C for 1hr then set for 24±2 hrs at room temp.</p> <p>* Cap. / D.F. / I.R. Measurement to be made after de-aging at 150°C for 1hr then set for 24±2 hrs at room temp.</p>	<p>* No remarkable damage.</p> <p>* Cap. change : X7R, X5R, X6S : Within ±7.5%. Y5V : Within ±20%.</p> <p>* D.F., I.R. and dielectric strength : To meet initial requirements.</p> <p>* 25% max. leaching on each edge.</p>																					
9.	Temperature Cycle	<p>* Conduct the five cycles according to the temperatures and time.</p> <table border="1"> <thead> <tr> <th>Step</th> <th>Temp.(°C)</th> <th>Time(min.)</th> </tr> </thead> <tbody> <tr> <td>1</td> <td>Min. operating temp. +0/-3</td> <td>30±3</td> </tr> <tr> <td>2</td> <td>Room temp.</td> <td>2~3</td> </tr> <tr> <td>3</td> <td>Max. operating temp. +3/-0</td> <td>30±3</td> </tr> <tr> <td>4</td> <td>Room temp.</td> <td>2~3</td> </tr> </tbody> </table> <p>* Before initial measurement (Class II only) : To apply de-aging at 150°C for 1hr then set for 24±2 hrs at room temp.</p> <p>* Cap./D.F./I.R. measurement to made after de-aging at 150°C for 1hr then set for 24±2 hrs at room temp.</p>	Step	Temp.(°C)	Time(min.)	1	Min. operating temp. +0/-3	30±3	2	Room temp.	2~3	3	Max. operating temp. +3/-0	30±3	4	Room temp.	2~3	<p>* No remarkable damage.</p> <p>* Cap. change : X7R, X5R, X6S : Within ±7.5%. Y5V : Within ±20%.</p> <p>* D.F. : ≤150% of initial requirement.</p> <p>* I.R. : ≥25% of initial requirement.</p>						
Step	Temp.(°C)	Time(min.)																						
1	Min. operating temp. +0/-3	30±3																						
2	Room temp.	2~3																						
3	Max. operating temp. +3/-0	30±3																						
4	Room temp.	2~3																						

## 8. RELIABILITY TEST CONDITIONS AND REQUIREMENTS

No.	Item	Test Condition	Requirements										
10.	Humidity (Damp Heat) Steady State	<ul style="list-style-type: none"> <li>* Test temp. : 40±2°C.</li> <li>* Humidity : 90~95%RH.</li> <li>* Test time : 500 +24/-0hrs.</li> <li>* Measurement to be made after keeping at room temp. for 48±4 hrs (Class II).</li> </ul>	<ul style="list-style-type: none"> <li>* No remarkable damage.</li> <li>* Cap. change : X7R, X5R, X6S : Within ±12.5% for ≥10V**, within ±25% for 6.3V. **10V : Within ±25% for 0603≥4.7μF, 0402≥1μF, 0201≥0.1μF. Y5V : Within ±30% for ≥10V, within +30/-40% for 6.3V.</li> <li>* D.F.(Class II) : ≤200% of initial requirement.</li> <li>* I.R. : ≥10V, ≥1GΩ or RxC≥50Ω-F, whichever is smaller. 6.3V, RxC≥10Ω-F.</li> </ul>										
11.	Humidity (Damp Heat) Load	<ul style="list-style-type: none"> <li>* Test temp. : 40±2°C.</li> <li>* Humidity : 90~95%RH.</li> <li>* Test time : 500 +24/-0hrs.</li> <li>* To apply voltage : Rated voltage (500V max.).</li> <li>* Measurement to be made after keeping at room temp. for 48±4 hrs (Class II).</li> </ul>	<ul style="list-style-type: none"> <li>* No remarkable damage.</li> <li>* Cap. change : X7R, X5R, X6S : Within ±12.5% for ≥10V**, within ±25% for 6.3V. **10V : Within ±25% for 0603≥4.7μF, 0402≥1μF, 0201≥0.1μF. Y5V : Within ±30% for ≥10V, within +30/-40% for 6.3V.</li> <li>* D.F.(Class II) : ≤200% of initial requirement.</li> <li>* I.R. : ≥10V, ≥500MΩ or RxC≥25Ω-F, whichever is smaller.</li> </ul> <p>Class II (X7R, X5R, X6S, Y5V)</p> <table border="1"> <thead> <tr> <th>Rated voltage</th> <th>I.R.</th> </tr> </thead> <tbody> <tr> <td>100V : All X7R, 1210≥3.3μF</td> <td rowspan="7">≥500MΩ or RxC≥5Ω-F, whichever is smaller</td> </tr> <tr> <td>50V : 0402&gt;0.01μF, 0603≥1μF, 0805≥1μF, 1206≥4.7μF, 1210≥4.7μF</td> </tr> <tr> <td>35V : 0603≥1μF, 0805≥2.2μF, 1206≥2.2μF, 1210≥10μF</td> </tr> <tr> <td>25V : 0201≥0.1μF, 0402≥0.22μF, 0603≥2.2μF, 0805≥2.2μF, 1206≥10μF, 1210≥10μF</td> </tr> <tr> <td>16V : 0201≥0.1μF, 0402≥0.22μF, 0603≥1μF, 0805≥2.2μF, 1206≥10μF, 1210≥47μF</td> </tr> <tr> <td>10V : 0201≥47nF, 0402≥0.47μF, 0603≥0.47μF, 0805≥2.2μF, 1206≥4.7μF, 1210≥47μF</td> </tr> <tr> <td>6.3V, 4V, All X6S/X7S items, Size≥1812</td> </tr> </tbody> </table>	Rated voltage	I.R.	100V : All X7R, 1210≥3.3μF	≥500MΩ or RxC≥5Ω-F, whichever is smaller	50V : 0402>0.01μF, 0603≥1μF, 0805≥1μF, 1206≥4.7μF, 1210≥4.7μF	35V : 0603≥1μF, 0805≥2.2μF, 1206≥2.2μF, 1210≥10μF	25V : 0201≥0.1μF, 0402≥0.22μF, 0603≥2.2μF, 0805≥2.2μF, 1206≥10μF, 1210≥10μF	16V : 0201≥0.1μF, 0402≥0.22μF, 0603≥1μF, 0805≥2.2μF, 1206≥10μF, 1210≥47μF	10V : 0201≥47nF, 0402≥0.47μF, 0603≥0.47μF, 0805≥2.2μF, 1206≥4.7μF, 1210≥47μF	6.3V, 4V, All X6S/X7S items, Size≥1812
Rated voltage	I.R.												
100V : All X7R, 1210≥3.3μF	≥500MΩ or RxC≥5Ω-F, whichever is smaller												
50V : 0402>0.01μF, 0603≥1μF, 0805≥1μF, 1206≥4.7μF, 1210≥4.7μF													
35V : 0603≥1μF, 0805≥2.2μF, 1206≥2.2μF, 1210≥10μF													
25V : 0201≥0.1μF, 0402≥0.22μF, 0603≥2.2μF, 0805≥2.2μF, 1206≥10μF, 1210≥10μF													
16V : 0201≥0.1μF, 0402≥0.22μF, 0603≥1μF, 0805≥2.2μF, 1206≥10μF, 1210≥47μF													
10V : 0201≥47nF, 0402≥0.47μF, 0603≥0.47μF, 0805≥2.2μF, 1206≥4.7μF, 1210≥47μF													
6.3V, 4V, All X6S/X7S items, Size≥1812													

## 8. RELIABILITY TEST CONDITIONS AND REQUIREMENTS

No.	Item	Test Condition	Requirements																																																																												
12.	<b>High Temperature Load (Endurance)</b>	* Test temp. : X7R : 125±3°C. X6S : 105±3°C. X5R, Y5V : 85±3°C. * To apply voltage : (1) ≤6.3V or Cap.≥10μF : 150% of rated voltage. (2) 10V≤Ur<500V : 200% of rated voltage. (3) 500V : 150% of rated voltage. (4) Ur≥630V : 120% of rated voltage. (5) 100% of rated voltage for below range :	* No remarkable damage. * Cap. change : X7R, X5R, X6S : Within ±12.5% for ≥10V**, within ±25% for ≤6.3V. **10V : Within ±25% for 0603≥4.7μF, 0402≥1μF, 0201≥0.1μF. Y5V : Within ±30% for ≥10V, within +30/-40% for ≤6.3V. * D.F.(Class II) : ≤200% of initial requirement. * I.R. : ≥10V, ≥1GΩ or RxC≥50Ω-F, whichever is smaller. Class II (X7R, X5R, X6S, Y5V)																																																																												
		<table border="1"> <thead> <tr> <th>Size</th> <th>Dielectric</th> <th>Rated</th> <th>Capacitance range</th> </tr> </thead> <tbody> <tr> <td rowspan="2">0201</td> <td rowspan="2">X5R/X7R/X6S</td> <td>≤10V</td> <td>C≥0.1μF</td> </tr> <tr> <td>≥16V</td> <td>C&gt;0.1μF</td> </tr> <tr> <td rowspan="2">0402</td> <td rowspan="2">X5R/X7R/X6S /Y5V</td> <td>6.3V, 10V, 16V, 25V</td> <td>C≥1.0μF</td> </tr> <tr> <td>4V</td> <td>C≥22μF</td> </tr> <tr> <td rowspan="2">0603</td> <td rowspan="2">X5R/X7R/X6S</td> <td>6.3V, 10V</td> <td>C≥4.7μF</td> </tr> <tr> <td>25V, 35V</td> <td>C≥1.0μF</td> </tr> <tr> <td rowspan="2">0805</td> <td rowspan="2">X5R/X7R/X6S</td> <td>4V</td> <td>C≥47μF</td> </tr> <tr> <td>6.3V</td> <td>C≥22μF</td> </tr> <tr> <td rowspan="2">1206</td> <td rowspan="2">X5R/X7R/X6S</td> <td>10V-50V</td> <td>C≥10μF</td> </tr> <tr> <td>≤6.3V</td> <td>C≥47μF</td> </tr> <tr> <td rowspan="2">1210</td> <td rowspan="2">X5R/X7R/X6S</td> <td>16V</td> <td>C≥47μF</td> </tr> <tr> <td>X7R</td> <td>100V</td> <td>C≥3.3μF</td> </tr> </tbody> </table>		Size	Dielectric	Rated	Capacitance range	0201	X5R/X7R/X6S	≤10V	C≥0.1μF	≥16V	C>0.1μF	0402	X5R/X7R/X6S /Y5V	6.3V, 10V, 16V, 25V	C≥1.0μF	4V	C≥22μF	0603	X5R/X7R/X6S	6.3V, 10V	C≥4.7μF	25V, 35V	C≥1.0μF	0805	X5R/X7R/X6S	4V	C≥47μF	6.3V	C≥22μF	1206	X5R/X7R/X6S	10V-50V	C≥10μF	≤6.3V	C≥47μF	1210	X5R/X7R/X6S	16V	C≥47μF	X7R	100V	C≥3.3μF	<table border="1"> <thead> <tr> <th>Rated voltage</th> <th>I.R.</th> </tr> </thead> <tbody> <tr> <td>100V : All X7R, 1210≥3.3μF</td> <td rowspan="10">≥1GΩ or RxC≥10Ω-F, whichever is smaller</td> </tr> <tr> <td>50V : 0402&gt;0.01μF, 0603≥1μF, 0805≥1μF, 1206≥4.7μF, 1210≥4.7μF</td> </tr> <tr> <td>35V : 0603≥1μF, 0805≥2.2μF, 1206≥2.2μF, 1210≥10μF</td> </tr> <tr> <td>25V : 0201≥0.1uF, 0402≥0.22μF, 0603≥2.2μF, 0805≥2.2μF, 1206≥10μF, 1210≥10μF</td> </tr> <tr> <td>16V : 0201≥0.1uF, 0402≥0.22μF, 0603≥1μF, 0805≥2.2μF, 1206≥10μF, 1210≥47μF</td> </tr> <tr> <td>10V : 0201≥47nF, 0402≥0.47μF, 0603≥0.47μF, 0805≥2.2μF, 1206≥4.7μF, 1210≥47μF</td> </tr> <tr> <td colspan="2">6.3V, 4V, All X6S/X7S items, Size≥1812</td> </tr> </tbody> </table>	Rated voltage	I.R.	100V : All X7R, 1210≥3.3μF	≥1GΩ or RxC≥10Ω-F, whichever is smaller	50V : 0402>0.01μF, 0603≥1μF, 0805≥1μF, 1206≥4.7μF, 1210≥4.7μF	35V : 0603≥1μF, 0805≥2.2μF, 1206≥2.2μF, 1210≥10μF	25V : 0201≥0.1uF, 0402≥0.22μF, 0603≥2.2μF, 0805≥2.2μF, 1206≥10μF, 1210≥10μF	16V : 0201≥0.1uF, 0402≥0.22μF, 0603≥1μF, 0805≥2.2μF, 1206≥10μF, 1210≥47μF	10V : 0201≥47nF, 0402≥0.47μF, 0603≥0.47μF, 0805≥2.2μF, 1206≥4.7μF, 1210≥47μF	6.3V, 4V, All X6S/X7S items, Size≥1812																								
		Size		Dielectric	Rated	Capacitance range																																																																									
		0201		X5R/X7R/X6S	≤10V	C≥0.1μF																																																																									
					≥16V	C>0.1μF																																																																									
		0402		X5R/X7R/X6S /Y5V	6.3V, 10V, 16V, 25V	C≥1.0μF																																																																									
					4V	C≥22μF																																																																									
		0603		X5R/X7R/X6S	6.3V, 10V	C≥4.7μF																																																																									
					25V, 35V	C≥1.0μF																																																																									
		0805		X5R/X7R/X6S	4V	C≥47μF																																																																									
					6.3V	C≥22μF																																																																									
		1206		X5R/X7R/X6S	10V-50V	C≥10μF																																																																									
≤6.3V	C≥47μF																																																																														
1210	X5R/X7R/X6S	16V	C≥47μF																																																																												
		X7R	100V	C≥3.3μF																																																																											
Rated voltage	I.R.																																																																														
100V : All X7R, 1210≥3.3μF	≥1GΩ or RxC≥10Ω-F, whichever is smaller																																																																														
50V : 0402>0.01μF, 0603≥1μF, 0805≥1μF, 1206≥4.7μF, 1210≥4.7μF																																																																															
35V : 0603≥1μF, 0805≥2.2μF, 1206≥2.2μF, 1210≥10μF																																																																															
25V : 0201≥0.1uF, 0402≥0.22μF, 0603≥2.2μF, 0805≥2.2μF, 1206≥10μF, 1210≥10μF																																																																															
16V : 0201≥0.1uF, 0402≥0.22μF, 0603≥1μF, 0805≥2.2μF, 1206≥10μF, 1210≥47μF																																																																															
10V : 0201≥47nF, 0402≥0.47μF, 0603≥0.47μF, 0805≥2.2μF, 1206≥4.7μF, 1210≥47μF																																																																															
6.3V, 4V, All X6S/X7S items, Size≥1812																																																																															
(6) 150% of rated voltage for below range :		<table border="1"> <thead> <tr> <th>Size</th> <th>Dielectric</th> <th>Rated Voltage</th> <th>Capacitance</th> </tr> </thead> <tbody> <tr> <td rowspan="2">0201</td> <td rowspan="2">X5R/X7R/X6S</td> <td>16V/25V</td> <td>C≥0.1μF</td> </tr> <tr> <td>X7R</td> <td>16V</td> <td>C≥0.022μF</td> </tr> <tr> <td rowspan="2">0402</td> <td rowspan="2">X5R/X7R/X6S</td> <td>50V</td> <td>C≥0.1μF</td> </tr> <tr> <td>Y5V</td> <td>10-25V</td> <td>C≥0.22μF</td> </tr> <tr> <td rowspan="2">0603</td> <td rowspan="2">X5R/X7R/X6S</td> <td>16V</td> <td>C≥0.47μF</td> </tr> <tr> <td>X7R</td> <td>50V</td> <td>C&gt;0.1μF</td> </tr> <tr> <td rowspan="2">0805</td> <td rowspan="2">X5R/X7R/X6S</td> <td>10V, 16V, 50V</td> <td>C≥1.0μF</td> </tr> <tr> <td>Y5V</td> <td>16V</td> <td>C≥2.2μF</td> </tr> <tr> <td rowspan="2">1206</td> <td rowspan="2">X5R/X7R/X6S</td> <td>10-50V</td> <td>C≥4.7μF</td> </tr> <tr> <td>Y5V</td> <td>16V</td> <td>C≥4.7μF</td> </tr> <tr> <td rowspan="2">1210</td> <td rowspan="2">X5R/X7R/X6S</td> <td>50V</td> <td>C≥2.2μF</td> </tr> <tr> <td>Y5V</td> <td>100V</td> <td>C≥0.12μF</td> </tr> <tr> <td rowspan="2">1812</td> <td rowspan="2">X7R</td> <td>50V</td> <td>C≥2.2μF</td> </tr> <tr> <td>100V</td> <td>C≥0.12μF</td> </tr> <tr> <td rowspan="2">1825</td> <td rowspan="2">X7R</td> <td>16V</td> <td>C≥4.7μF</td> </tr> <tr> <td>50V</td> <td>C≥2.2μF</td> </tr> <tr> <td rowspan="2">2220</td> <td rowspan="2">X7R</td> <td>100V</td> <td>C≥1.0μF</td> </tr> <tr> <td>50V</td> <td>C≥1.0μF</td> </tr> <tr> <td rowspan="2">2225</td> <td rowspan="2">X7R</td> <td>200V-250V</td> <td>C≥0.22μF</td> </tr> <tr> <td>100V</td> <td>C≥1.0μF</td> </tr> <tr> <td rowspan="2">2225</td> <td rowspan="2">X7R</td> <td>200V-250V</td> <td>C≥0.47μF</td> </tr> <tr> <td>100V</td> <td>C≥1.0μF</td> </tr> </tbody> </table>	Size	Dielectric	Rated Voltage	Capacitance	0201	X5R/X7R/X6S	16V/25V	C≥0.1μF	X7R	16V	C≥0.022μF	0402	X5R/X7R/X6S	50V	C≥0.1μF	Y5V	10-25V	C≥0.22μF	0603	X5R/X7R/X6S	16V	C≥0.47μF	X7R	50V	C>0.1μF	0805	X5R/X7R/X6S	10V, 16V, 50V	C≥1.0μF	Y5V	16V	C≥2.2μF	1206	X5R/X7R/X6S	10-50V	C≥4.7μF	Y5V	16V	C≥4.7μF	1210	X5R/X7R/X6S	50V	C≥2.2μF	Y5V	100V	C≥0.12μF	1812	X7R	50V	C≥2.2μF	100V	C≥0.12μF	1825	X7R	16V	C≥4.7μF	50V	C≥2.2μF	2220	X7R	100V	C≥1.0μF	50V	C≥1.0μF	2225	X7R	200V-250V	C≥0.22μF	100V	C≥1.0μF	2225	X7R	200V-250V	C≥0.47μF	100V	C≥1.0μF	
Size		Dielectric	Rated Voltage	Capacitance																																																																											
0201		X5R/X7R/X6S	16V/25V	C≥0.1μF																																																																											
	X7R		16V	C≥0.022μF																																																																											
0402	X5R/X7R/X6S	50V	C≥0.1μF																																																																												
		Y5V	10-25V	C≥0.22μF																																																																											
0603	X5R/X7R/X6S	16V	C≥0.47μF																																																																												
		X7R	50V	C>0.1μF																																																																											
0805	X5R/X7R/X6S	10V, 16V, 50V	C≥1.0μF																																																																												
		Y5V	16V	C≥2.2μF																																																																											
1206	X5R/X7R/X6S	10-50V	C≥4.7μF																																																																												
		Y5V	16V	C≥4.7μF																																																																											
1210	X5R/X7R/X6S	50V	C≥2.2μF																																																																												
		Y5V	100V	C≥0.12μF																																																																											
1812	X7R	50V	C≥2.2μF																																																																												
		100V	C≥0.12μF																																																																												
1825	X7R	16V	C≥4.7μF																																																																												
		50V	C≥2.2μF																																																																												
2220	X7R	100V	C≥1.0μF																																																																												
		50V	C≥1.0μF																																																																												
2225	X7R	200V-250V	C≥0.22μF																																																																												
		100V	C≥1.0μF																																																																												
2225	X7R	200V-250V	C≥0.47μF																																																																												
		100V	C≥1.0μF																																																																												
(7) 120% of rated voltage for below range :	<table border="1"> <thead> <tr> <th>Size</th> <th>Dielectric</th> <th>Rated Voltage</th> <th>Capacitance</th> </tr> </thead> <tbody> <tr> <td>1210</td> <td>X7R</td> <td>100V</td> <td>C≥3.3μF</td> </tr> </tbody> </table>	Size	Dielectric	Rated Voltage	Capacitance	1210	X7R	100V	C≥3.3μF																																																																						
Size	Dielectric	Rated Voltage	Capacitance																																																																												
1210	X7R	100V	C≥3.3μF																																																																												
	* Test time : 1000 +24/-0 hrs. * Before initial measurement (Class II only) : To apply de-aging at 150°C for 1hr then set for 24±2 hrs at room temp. * Cap./D.F./I.R. measurement to be made after de-aging at 150°C for 1hr then set for 24±2 hrs at room temp. ** De-rating conditions :																																																																														
	<p>The graph shows the de-rating curve for three different temperature classes: 125°C (solid line), 105°C (dashed line), and 85°C (dotted line). The y-axis represents the Ratio (Operating Voltage/Rated Voltage (%)) from 0 to 120. The x-axis represents the Temperature at Product (°C) from 0 to 150. All curves start at 100% at 0°C and remain constant until 75°C. After 75°C, the curves slope downwards. The 125°C curve reaches approximately 70% at 150°C. The 105°C curve reaches approximately 80% at 150°C. The 85°C curve reaches approximately 90% at 150°C.</p>																																																																														

## 8. RELIABILITY TEST CONDITIONS AND REQUIREMENTS

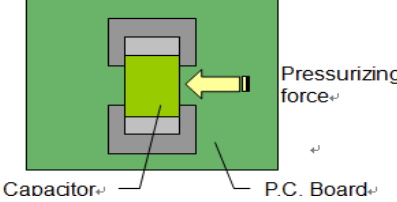
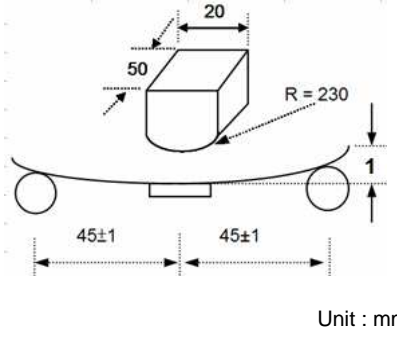
No.	Item	Test Condition	Requirements						
13.	Adhesive Strength of Termination	<p>* Capacitors mounted on a substrate. A force of 5N(<math>\leq 0603</math>) or 10N(<math>&gt;0603</math>) applied perpendicular to the place of substrate and parallel the line joining the center of terminations for <math>10 \pm 1</math> second.</p> 	<p>* No remarkable damage or removal of the terminations.</p>						
14.	Bending Test	<p>* The middle part of substrate shall be pressurized by means of the pressurizing rod at a rate of about 1mm per second until the deflection becomes 1mm.</p> 	<p>* No remarkable damage.</p> <table border="1"> <thead> <tr> <th>Dielectric</th> <th>Cap. Change</th> </tr> </thead> <tbody> <tr> <td>Class II (X7R, X5R, X6S)</td> <td>Within <math>\pm 12.5\%</math></td> </tr> <tr> <td>Class II (Y5V)</td> <td>Within <math>\pm 30\%</math></td> </tr> </tbody> </table> <p>(This capacitance change means the change of capacitance under specified flexure of substrate from the capacitance measured before the test)</p>	Dielectric	Cap. Change	Class II (X7R, X5R, X6S)	Within $\pm 12.5\%$	Class II (Y5V)	Within $\pm 30\%$
Dielectric	Cap. Change								
Class II (X7R, X5R, X6S)	Within $\pm 12.5\%$								
Class II (Y5V)	Within $\pm 30\%$								
15.	Vibration Resistance	<p>* Vibration frequency : 10~55 Hz/min.            * Total amplitude : 1.5mm.            * Test time : 6 hrs. (Two hrs each in three mutually perpendicular directions)</p>	<p>* No remarkable damage.            * Cap. change and D.F. : To meet initial spec.</p>						

## 9. PACKAGE DIMENSION AND QUANTITY

Size	Thickness (mm)/Symbol		Paper tape		Plastic tape	
			7" reel	13" reel	7" reel	13" reel
0201(0603)	0.30±0.03	L	15k	70k	-	-
	0.30±0.05	L	15k	-	-	-
	0.30±0.09	L	15k	-	-	-
0402(1005)	0.50±0.05	N	10k	50k	-	-
	0.50 +0.02/-0.05	Q	10k	50k	-	-
	0.50±0.20	K	10k	-	-	-
0603(1608)	0.50±0.10	U	4k	-	-	-
	0.80±0.07	S	4k	15k	-	-
	0.80 +0.15/-0.10	B	4k	15k	-	-
0805(2012)	0.50±0.10	U	4k	15k	-	-
	0.60±0.10	A	4k	15k	-	-
	0.80±0.10	X	4k	15k	-	-
	0.85±0.10	T	4k	15k	-	-
	1.25±0.10	C	-	-	3k	10k
	1.25±0.20	I	-	-	3k	10k
1206(3216)	0.80±0.10	X	4k	15k	-	-
	0.85±0.10	T	4k	15k	-	-
	0.95±0.10	M	-	-	3k	10k
	1.15±0.15	J	-	-	3k	10k
	1.25±0.10	C	-	-	3k	10k
	1.60±0.20	E	-	-	2k	10k
	1.60 +0.30/-0.10	P	-	-	2k	9k
1210(3225)	0.85±0.10	T	-	-	3k	10k
	0.95±0.10	M	-	-	3k	10k
	1.25±0.10	C	-	-	3k	10k
	1.60±0.20	E	-	-	2k	-
	2.00±0.20	F	-	-	1k	6k
	2.50±0.30	G	-	-	1k	6k
1808(4520)	1.25±0.10	C	-	-	2k	10k
	1.60±0.20	E	-	-	2k	8k
	2.00±0.20	F	-	-	1k	6k
1812(4532)	1.25±0.10	C	-	-	1k	5k
	1.60±0.20	E	-	-	1k	-
	2.00±0.20	F	-	-	1k	-
	2.50±0.30	G	-	-	0.5k	3k
1825(4563)	2.80±0.30	H	-	-	0.5k	-
	1.60±0.20	E	-	-	1k	-
	2.00±0.20	F	-	-	1k	-
	2.50±0.30	G	-	-	0.5k	-
2220(5750)	2.80±0.30	H	-	-	0.5k	-
	1.60±0.20	E	-	-	1k	-
	2.00±0.20	F	-	-	1k	-
2225(5763)	2.50±0.30	G	-	-	0.5k	-
	2.80±0.30	H	-	-	0.5k	-
	1.60±0.20	E	-	-	1k	-

Unit : pcs

## 9. PACKAGE DIMENSION AND QUANTITY

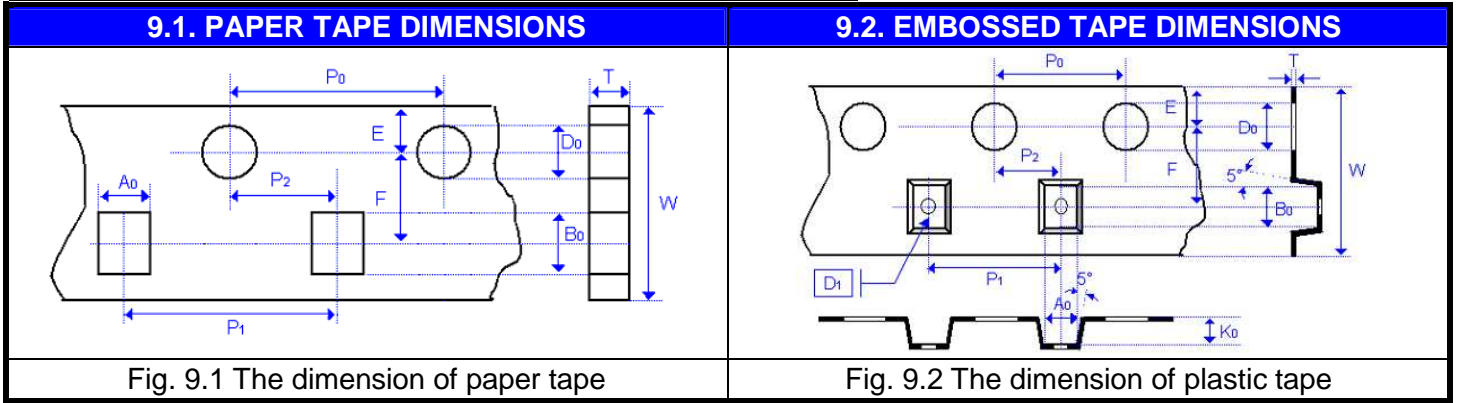

Size	0201	0402	0603		0805	
<b>Chip Thickness</b>	0.30±0.03	0.50±0.10	0.80±0.07	0.80 +0.15/-0.1	0.80±0.10	1.25±0.10 1.25±0.20
<b>A<sub>0</sub></b>	0.39±0.07	0.70±0.2	1.00 +0.05/-0.1	1.02 +0.05/-0.1	1.50±0.10	<1.65
<b>B<sub>0</sub></b>	0.69±0.07	1.20±0.2	1.80±0.10	1.80±0.10	2.30±0.10	<2.40
<b>T</b>	≤0.50	≤0.80	0.95±0.05	0.97±0.05	0.95±0.05	0.23±0.05
<b>K<sub>0</sub></b>	-	-	-	-	-	<2.50
<b>W</b>	8.00±0.10	8.00±0.10	8.00±0.10	8.00±0.10	8.00±0.10	8.00±0.10
<b>P<sub>0</sub></b>	4.00±0.10	4.00±0.10	4.00±0.10	4.00±0.10	4.00±0.10	4.00±0.10
<b>10xP<sub>0</sub></b>	40.00±0.10	40.00±0.10	40.00±0.2	40.00±0.2	40.00±0.2	40.00±0.20
<b>P<sub>1</sub></b>	2.00±0.05	2.00±0.05	4.00±0.10	4.00±0.10	4.00±0.10	4.00±0.10
<b>P<sub>2</sub></b>	2.00±0.05	2.00±0.05	2.00±0.05	2.00±0.05	2.00±0.05	2.00±0.05
<b>D<sub>0</sub></b>	1.55±0.05	1.55±0.05	1.55±0.05	1.55±0.05	1.55±0.05	1.50 +0.10/-0
<b>D<sub>1</sub></b>	-	-	-	-	-	1.00±0.10
<b>E</b>	1.75±0.05	1.75±0.05	1.75±0.05	1.75±0.05	1.75±0.05	1.75±0.10
<b>F</b>	3.50±0.05	3.50±0.05	3.50±0.05	3.50±0.05	3.50±0.05	3.50±0.05
<b>Unit :</b>	mm	mm	mm	mm	mm	mm

Size	1206			1210		1812	
<b>Chip Thickness</b>	0.80±0.10	0.95±0.10 1.25±0.10	1.60±0.20 1.60+0.3/-0/1	0.95±0.10 1.25±0.10 1.60±0.20	2.50±0.30	1.25±0.10 1.60±0.20 2.00±0.20	2.50±0.30
<b>A<sub>0</sub></b>	2.00±0.10	<2.00	<2.00	<3.05	<3.10	<3.90	<3.90
<b>B<sub>0</sub></b>	3.50±0.10	<3.60	<3.70	<3.80	<4.00	<5.30	<5.30
<b>T</b>	0.95±0.05	0.23±0.05	0.23±0.05	0.23±0.05	0.23±0.05	0.25±0.05	0.25±0.05
<b>K<sub>0</sub></b>	-	<2.50	<2.50	<2.50	<3.50	<2.50	<3.00
<b>W</b>	8.00±0.10	8.00±0.10	8.00±0.10	8.00±0.10	8.00±0.10	12.0±0.20	12.0±0.20
<b>P<sub>0</sub></b>	4.00±0.10	4.00±0.10	4.00±0.10	4.00±0.100	4.00±0.10	4.00±0.10	4.00±0.10
<b>10xP<sub>0</sub></b>	40.00±0.20	40.00±0.20	40.00±0.20	40.00±0.20	40.0±0.10	40.00±0.20	40.00±0.20
<b>P<sub>1</sub></b>	4.00±0.10	4.00±0.10	4.00±0.10	4.00±0.10	4.00±0.10	8.00±0.10	8.00±0.10
<b>P<sub>2</sub></b>	2.00±0.05	2.00±0.05	2.00±0.05	2.00±0.05	2.00±0.05	2.00±0.05	2.00±0.05
<b>D<sub>0</sub></b>	1.55±0.05	1.50 +0.10/-0	1.50 +0.10/-0	1.50 +0.10/-0	1.50 +0.10/-0	1.50 +0.10/-0	1.50 +0.10/-0
<b>D<sub>1</sub></b>	-	1.00±0.10	1.00±0.10	1.00±0.10	1.00±0.10	1.50±0.10	1.50±0.10
<b>E</b>	1.75±0.10	1.75±0.10	1.75±0.10	1.75±0.10	1.75±0.10	1.75±0.10	1.75±0.1
<b>F</b>	3.50±0.05	3.50±0.05	3.50±0.05	3.50±0.05	3.50±0.05	5.50±0.05	5.50±0.05
<b>Unit :</b>	mm	mm	mm	mm	mm	mm	mm

## 9. PACKAGE DIMENSION AND QUANTITY

Size	1825		2220		2225	
Chip Thickness	1.60±0.20 2.00±0.20	2.50±0.30	1.40±0.15 1.60±0.20 2.00±0.20	2.50±0.30	1.60±0.20 2.00±0.20	2.50±0.30
A <sub>0</sub>	<6.80	<6.80	<5.80	<5.80	<6.80	<6.80
B <sub>0</sub>	<5.30	<5.30	<6.50	<6.50	<6.50	<6.50
T	0.30±0.10	0.30±0.10	0.30±0.10	0.30±0.10	0.30±0.10	0.30±0.10
K <sub>0</sub>	<2.50	<3.10	<2.50	<3.10	<2.50	<3.10
W	12.0±0.20	12.0±0.20	12.0±0.20	12.0±0.20	12.0±0.20	12.0±0.20
P <sub>0</sub>	4.00±0.10	4.00±0.10	4.00±0.10	4.00±0.10	4.00±0.10	4.00±0.10
10xP <sub>0</sub>	40.00±0.20	40.00±0.20	40.00±0.20	40.00±0.20	40.00±0.20	40.00±0.20
P <sub>1</sub>	8.00±0.10	8.00±0.10	8.00±0.10	8.00±0.10	8.00±0.10	8.00±0.10
P <sub>2</sub>	2.00±0.05	2.00±0.05	2.00±0.05	2.00±0.05	2.00±0.05	2.00±0.05
D <sub>0</sub>	1.50 +0.10/-0	1.50 +0.10/-0	1.50 +0.10/-0	1.50 +0.10/-0	1.50 +0.10/-0	1.50 +0.10/-0
D <sub>1</sub>	1.50±0.10	1.50±0.10	1.50±0.10	1.50±0.10	1.50±0.10	1.50±0.10
E	1.75±0.1	1.75±0.10	1.75±0.1	1.75±0.10	1.75±0.10	1.75±0.10
F	5.50±0.05	5.50±0.05	5.50±0.05	5.50±0.05	5.50±0.05	5.50±0.05
Unit :	mm	mm	mm	mm	mm	mm

### 9.3. REEL DIMENSIONS

Size	0201, 0402, 0603 0805, 1206, 1210			1808, 1812, 1825 2220, 2225
Reel size	7"	7"	13"	7"
C	13.0 +0.5/-0.2	13.0 +0.5/-0.2	13.0 +0.5/-0.2	13.0 +0.5/-0.2
W <sub>1</sub>	8.4 +1.5/-0	12.4 +2.0/-0	8.4 +1.5/-0	8.4 +1.5/-0
A	178.0 ±0.10	178.0 ±0.10	330.0 ±1.0	178.0 ±0.10
N	60.0 +1.0/-0	80.0 ±1.0	100 ±1.0	60.0 +1.0/-0

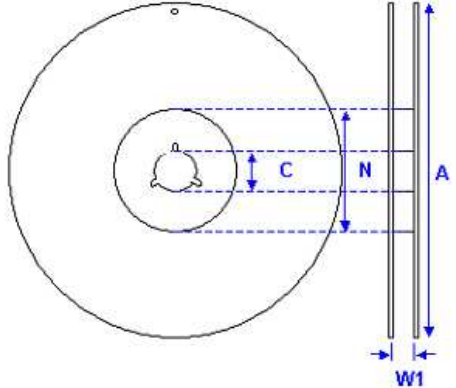

Fig. 9.3 The dimension of reel

## 10. APPLICATION NOTES

### STORAGE

To prevent the damage of solderability of terminations, the following storage conditions are recommended :

Indoors under 5 ~ 40°C and 20% ~ 70% RH.

No harmful gases containing sulfuric acid, ammonia, hydrogen sulfide or chlorine.

Packaging should not be opened until the capacitors are required for use. If opened, the pack should be re-sealed as soon as is practicable. Taped product should be stored out of direct sunlight, which might promote deterioration in tape or adhesion performance. The product is recommended to be used within 12 months after shipment and checked the solderability before use.

### HANDLING

Chip capacitors are dense, hard, brittle, and abrasive materials. They are liable to suffer mechanical damage, in the form of cracks or chips. Chip Capacitors should be handled with care to avoid contamination or damage. To use vacuum or plastic tweezers to pick up or plastic tweezers is recommended for manual placement. Tape and reeled packages are suitable for automatic pick and placement machine.

### PREHEAT

In order to minimize the risk of thermal shock during soldering, a carefully controlled preheat is required. The rate of preheat should not exceed 3°C per second.

### SOLDERING

Use mildly activated rosin RA and RMA fluxes do not use activated flux. The amount of solder in each solder joint should be controlled to prevent the damage of chip capacitors caused by the stress between solder, chips, and substrate.

a.) Hand soldering :

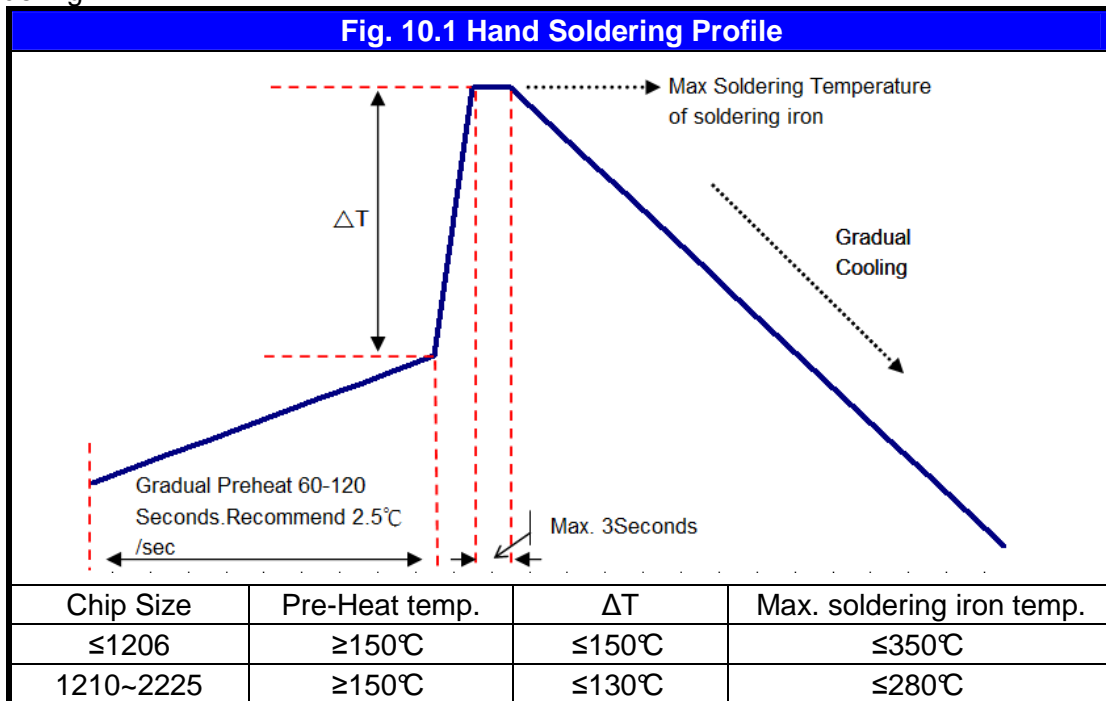

\* Soldering iron tip diameter ≤1.0 mm and wattage max. 20W.

\* The Capacitors shall be pre-heated and that the temperature gradient between the devices and the tip of the soldering iron.

\* The required amount of solder shall be melted on the soldering tip.

\* The tip of iron should not contact the ceramic body directly.

\* The Capacitors shall be cooled gradually at room temperature after soldering.

\* Forced air cooling is not allowed.



## 10. APPLICATION NOTES

b.) Reflow soldering :

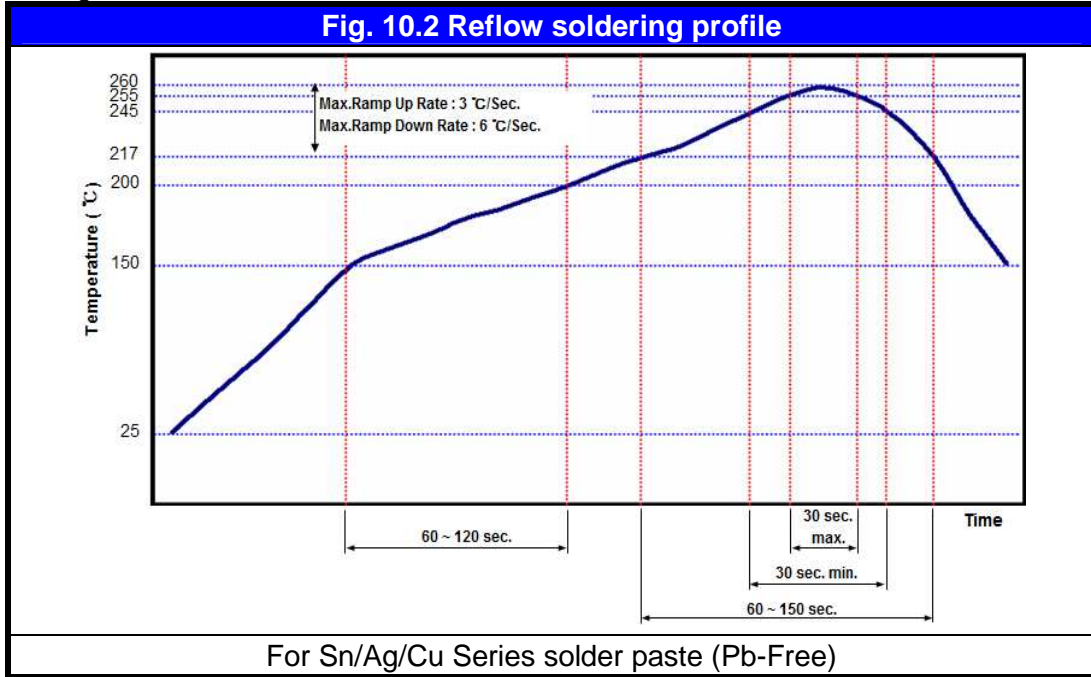

c.) Wave soldering :

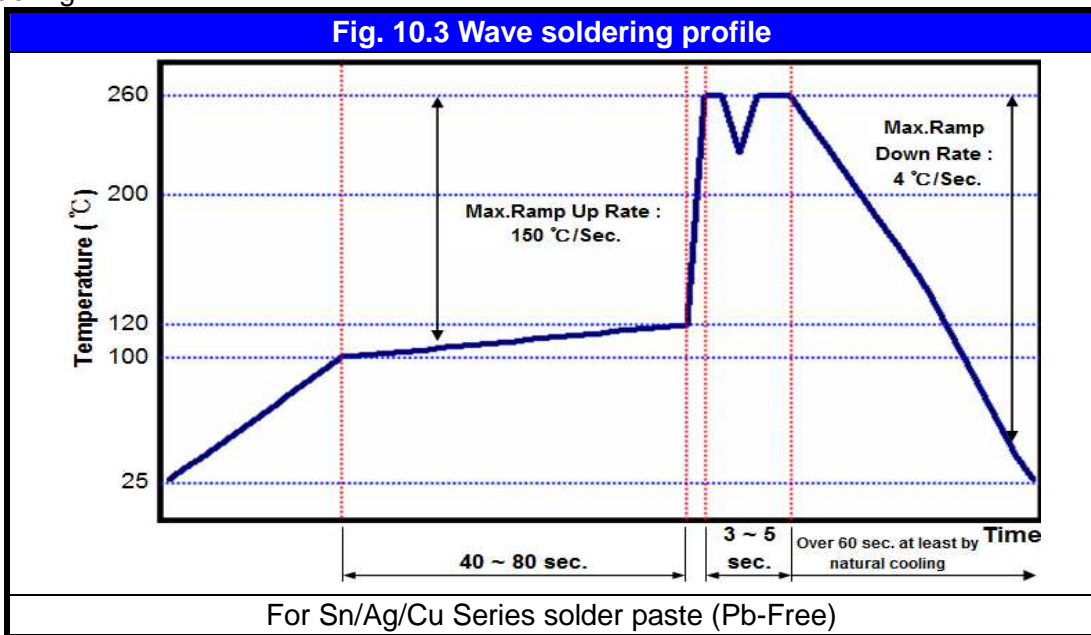

Soldering conditions :

Class I :

Size Inch (mm)	Temper. Cher.	Capacitance	Condition	
			Wave	Reflow
≤0402(1005)	Class I - C0G	All	X	O
0603(1608)	Class I - C0G	All	O	O
0805(2012)	Class I - C0G	All	O	O
1206(3216)	Class I - C0G	All	O	O
≥1210(3225)	Class I - C0G	All	X	O

## 10. APPLICATION NOTES

Soldering conditions :

Class II :

Size Inch (mm)	Temper. Cher.	Capacitance	Condition	
			Wave	Reflow
≤0402(1005)	Class II - X7R	All	X	O
0603 (1608)	Class II - X7R	Cap. <2.2μF	O	O
		Cap. ≥2.2μF	X	O
0805 (2012)	Class II - X7R	Cap. <4.7μF	O	O
		Cap. ≥4.7μF	X	O
1206 (3216)	Class II - X7R	Cap. <4.7μF	O	O
		Cap. ≥4.7μF	X	O
≥1210 (3225)	Class II - X7R	All	X	O

Soldering height :

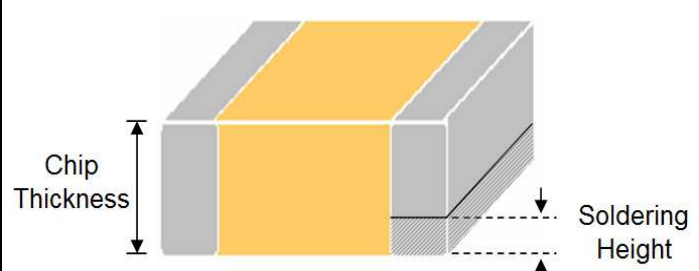
<p>The solder climbing minimum height is suggesting to 25% of chip thickness or 500um whichever is less. (Reference from IPC-610E)</p>	
--	---

### COOLING

After soldering, cool the chips and the substrate gradually to room temperature. Natural cooling in air is recommended to minimize stress in the solder joint.

### CLEANING

All flux residues must be removed by using suitable electronic-grade vapor-cleaning solvents to eliminate contamination that could cause electrolytic surface corrosion. Good results can be obtained by using ultrasonic cleaning of the solvent. The choice of the proper system is depends upon many factors such as component mix, flux, and solder paste and assembly method. The ability of the cleaning system to remove flux residues and contamination from under the chips is very important.