

# 1A, Low IQ, High Accuracy, Fast Transient Low Dropout Voltage Regulator

## DESCRIPTION

ETA5060 is a low dropout (LDO) voltage regulator capable of sourcing 1A with only 140mV of dropout. ETA5060 output is adjustable with external resistors from 0.8V to 5V. ETA5060 wide input-voltage range supports operation as low as 1.8V and up to 5.5 V.

ETA5060 is designed to have high accuracy, 2% at output voltage over line, load, and temperature. And ETA5060 soft-start capabilities to reduce in-rush current. ETA5060 is ideal for powering sensitive analog low-voltage devices.

ETA5060 is available in SOT89-5, HFBP1.2x1.6-8, DFN1.2x1.6-8, DFN2x2-6 and DFN2x2-8 packages.

## FEATURES

- ◆ Programmable Output Voltage Configuration
- ◆ High Accuracy Output Voltage:  $\pm 2\%$
- ◆ Wide Input Voltage Range: 1.8V to 5.5V
- ◆ Wide Output Voltage Range: 0.8V to 5V
- ◆ Low Power Consumption: 20 $\mu$ A Quiescent Current
- ◆ Low Dropout: 140mV at 1A
- ◆ Fast Transient Response
- ◆ Stable with Small 1 $\mu$ F Capacitor
- ◆ Inrush Current Protection
- ◆ Available in SOT89-5, HFBP1.2x1.6-8, DFN1.2x1.6-8, DFN2x2-6, and DFN2x2-8

## APPLICATIONS

- ◆ USB Ports and Hubs
- ◆ Digital TVs
- ◆ Set-Top Boxes
- ◆ VOIP Phones

## TYPICAL APPLICATION

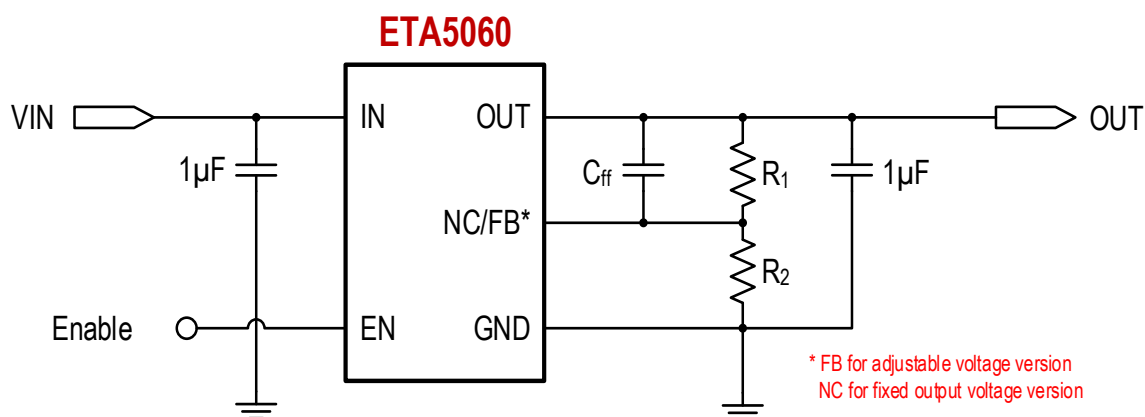

ORDERING INFORMATION	PART No.	PACKAGE	TOP MARK	Pcs/Reel
	ETA5060VXXXS8F	SOT89-5	SGxYW	1000
	ETA5060VXXXHBI	HFBP1.2x1.6-8	SGxYW	3000
	ETA5060VXXXDBI	DFN1.2x1.6-8	SGxYW	3000
	ETA5060V0D2G	DFN2x2-6	SG0YW	3000
	ETA5060VXXXD2I	DFN2x2-8	SGxYW	3000

## PIN CONFIGURATION

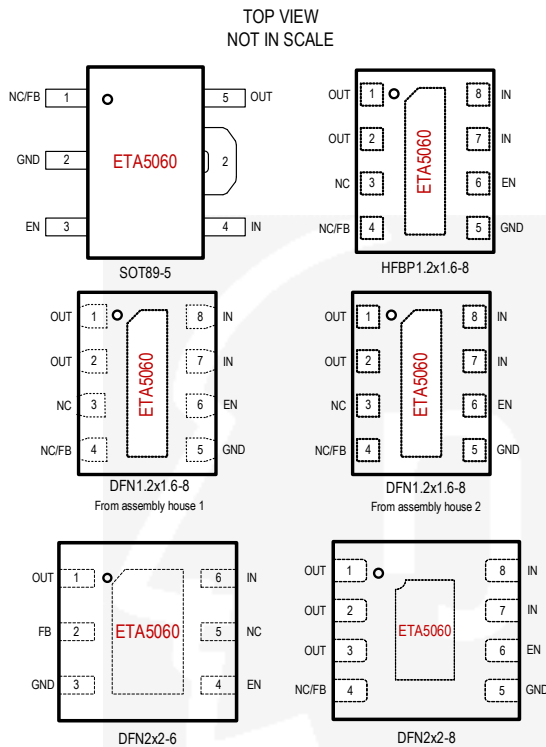

## ABSOLUTE MAXIMUM RATINGS

(Note: Exceeding these limits may damage the device. Exposure to absolute maximum rating conditions for long periods may affect device reliability.)

IN, OUT Pin Voltage to GND. ....	-0.3V to 5.5V
FB, EN Pin Voltage to GND .....	-0.3V to 5.5V
OUT to ground current.....	Internally limited
Operating Temp Range .....	-40°C to 85°C
Storage Temp Range .....	-55°C to 170°C
Thermal Resistance $\theta_{JC}$ $\theta_{JA}$	
SOT89-5 .....	47.....77.....°C/W
HFBP1.2x1.6-8 .....	30.....111.....°C/W
DFN1.2x1.6-8.....	30.....111.....°C/W
DFN2x2-6.....	30.....92.....°C/W
DFN2x2-8.....	20.....80.....°C/W
Lead Temp (Soldering, 10sec).....	260°C
ESD HBM (Human Body Mode).....	3KV

## ELECTRICAL CHARACTERISTICS

( $V_{IN} = V_{OUT} + 1V$ , unless otherwise specified. Typical values are at  $T_A = 25^\circ C$ .)

PARAMETER	SYMBOL	TEST CONDITIONS	MIN	TYP	MAX	UNIT
Input Voltage Range	$V_{IN}^{(1)}$		1.8		5.5	V
Ground Current	$I_{Q\_HLOAD}$	No load		20		$\mu A$
Shutdown Current	$I_{SD}$	$V_{EN} = 0V, 1.8V \leq V_{IN} \leq 5.5V$		0.5		$\mu A$
Dropout Voltage	$V_{DROP}$	$I_{OUT} = 1A, V_{OUT} = 3.3V$		140		mV
Discharge Resistance	$R_{DIS}$	$V_{EN} = 0V$		30		$\Omega$
Output Current Limit	$I_{LIM}$	$V_{OUT} = 95\%$	1.1	1.4		A
Enable Threshold	$V_{EN\_HI}$		0.8			V
Voltage	$V_{EN\_LO}$				0.71	V

PARAMETER	SYMBOL	TESTCONDITIONS	MIN	TYP	MAX	UNIT
Line Regulation		$V_{OUT} + 1V \leq V_{IN} \leq 5.5V$		0.06		%/V
Load Regulation		$0\mu A \leq I_{OUT} \leq 1A$		11		mV
FB Feedback Voltage	$V_{REF}$			0.8		V
Output Voltage Accuracy	$V_{OUT\_NOM}$	$I_{OUT} = 1mA, -40^{\circ}C \leq T_J \leq 125^{\circ}C$	-2		2	%
Power Supply Rejection Ratio	PSRR	Frequency=100Hz, $I_{OUT}=100mA$ , $V_{OUT}=1.8V, V_{IN}=5V$		68		dB
		Frequency=100Hz, $I_{OUT}=100mA$ , $V_{OUT}=3.3V, V_{IN}=5V$		52		
Start-up time	TSS	$C_{OUT}=1\mu F$		30		$\mu s$
Thermal Shutdown	TSHUT	Rising, Hysteresis =30°C		150		°C

(1): Minimum  $V_{IN}$  is 1.8 V or  $V_{OUT} + V_{DROPOUT}$ , whichever is greater

## PIN DESCRIPTION

PIN NAME	ETA5060					DESCRIPTION
	SOT89-5	HFBP1.2x1.6-8	DFN1.2x1.6-8	DFN2x2-6	DFN2x2-8	
IN	4	7, 8	7, 8	6	7, 8	Input Supply Pin
OUT	5	1, 2	1, 2	1	1, 2, 3	Output of Regulator
GND	2	5	5	3	5	Ground Pin
NC	NA	3	3	5	NA	No electrical connection inside the chip
FB/NC	1	4	4	2	4	Feedback pin for output voltage configuration, FB only for adjustable voltage version, fixed voltage version internal no connection
EN	3	6	6	4	6	Enable Pin. Drive EN to a Logic-High to enable IC, drive EN Logic-Low to disable. EN is connected to GND via 2 MΩ resistor internally.
EP	NA	EP	EP	NA	EP	Thermal Pad (with the color of silver or gold). Connect the thermal pad to the printed circuit board (PCB) ground plane.

FUNCTIONAL BLOCK DIAGRAM

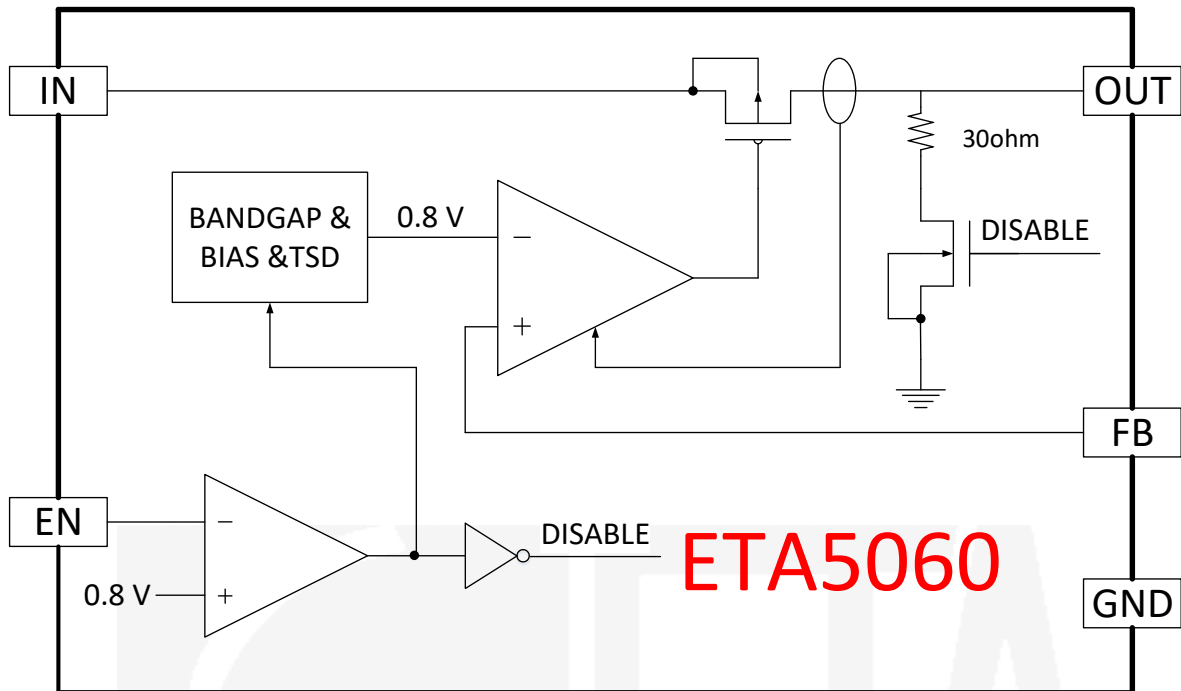

**ETA5060**

TYPICAL PERFORMANCE CHARACTERISTICS

( $T_A=25\text{ }^\circ\text{C}$ ,  $V_{IN}=5\text{V}$ ,  $C_{IN} = 1\mu\text{F}$ ,  $C_{OUT} = 1\mu\text{F}$ , unless otherwise specified)

Start-Up Waveform at No Load,  $V_{OUT}=1.2\text{V}$

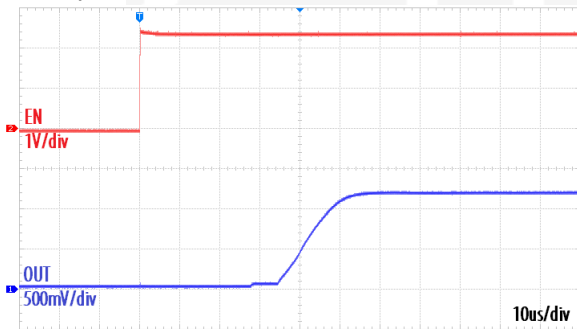

Start-Up Waveform with  $R_{OUT} = 1.2\Omega$ ,  $V_{OUT}=1.2\text{V}$

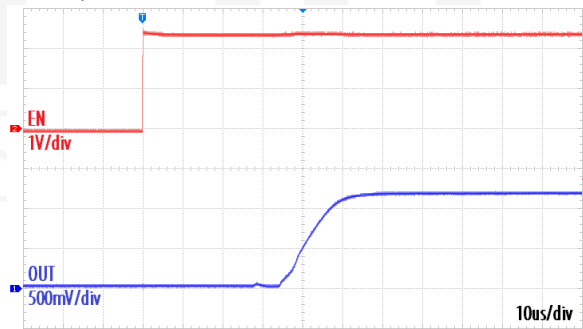

Start-Up Waveform at No Load,  $V_{OUT}=2.5\text{V}$

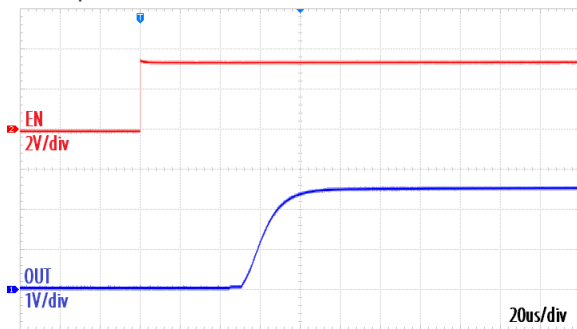

Start-Up Waveform with  $R_{OUT} = 2.5\Omega$ ,  $V_{OUT}=2.5\text{V}$

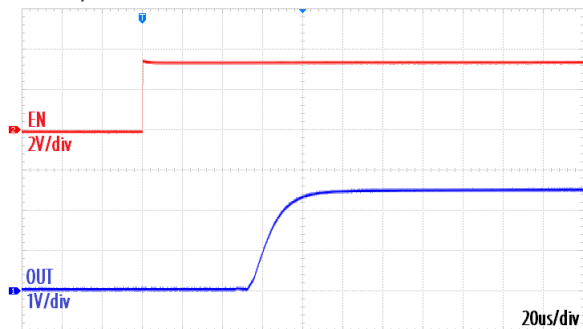

## TYPICAL PERFORMANCE CHARACTERISTICS CONT'D

( $T_A=25\text{ }^\circ\text{C}$ ,  $V_{IN}=5\text{V}$ ,  $C_{IN} = 1\mu\text{F}$ ,  $C_{OUT} = 1\mu\text{F}$ , unless otherwise specified)

Start-Up Waveform at No Load,  $V_{OUT}=3.3\text{V}$

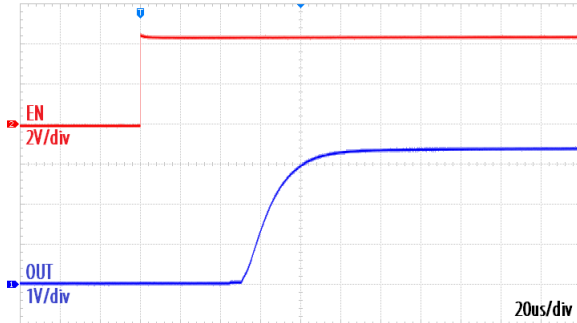

Start-Up Waveform with  $R_{OUT} = 3.3\Omega$ ,  $V_{OUT}=3.3\text{V}$

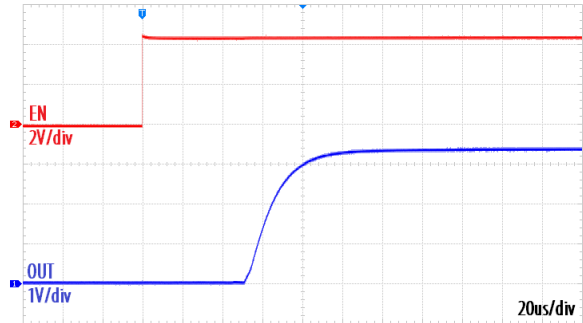

Shutdown Waveform at No Load,  $V_{OUT}=1.2\text{V}$

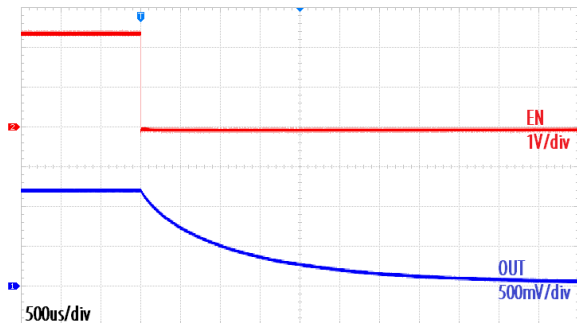

Shutdown Waveform with  $R_{OUT} = 1.2\Omega$ ,  $V_{OUT}=1.2\text{V}$

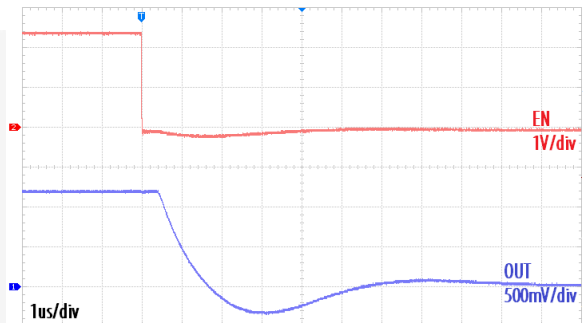

Shutdown Waveform at No Load,  $V_{OUT}=2.5\text{V}$

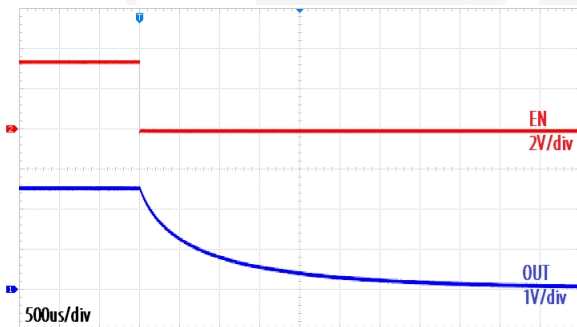

Shutdown Waveform with  $R_{OUT} = 2.5\Omega$ ,  $V_{OUT}=2.5\text{V}$

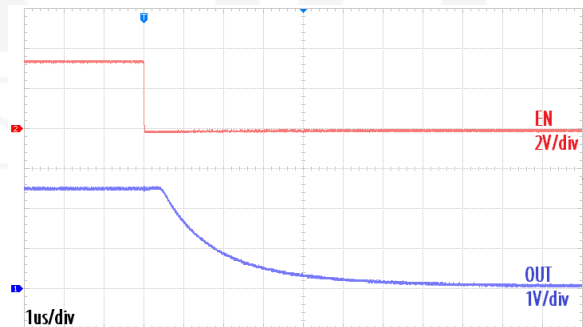

Shutdown Waveform at No Load,  $V_{OUT}=3.3\text{V}$

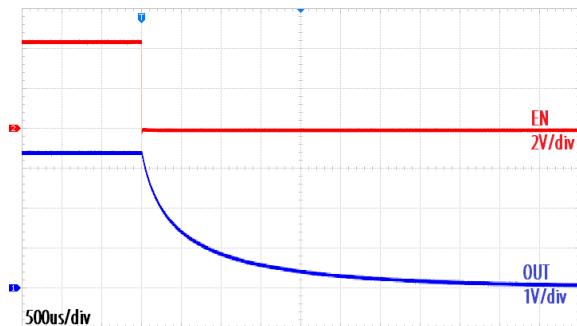

Shutdown Waveform with  $R_{OUT} = 3.3\Omega$ ,  $V_{OUT}=3.3\text{V}$

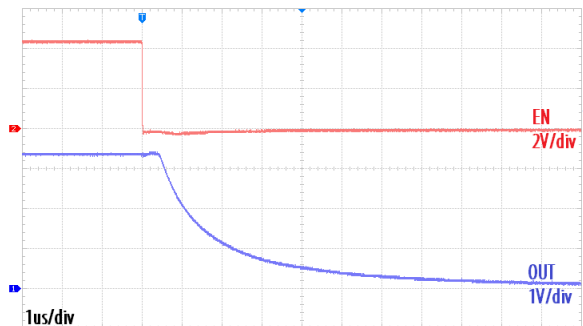

## TYPICAL PERFORMANCE CHARACTERISTICS CONT'D

( $T_A=25\text{ }^\circ\text{C}$ ,  $V_{IN}=5\text{V}$ ,  $C_{IN}=1\mu\text{F}$ ,  $C_{OUT}=1\mu\text{F}$ , unless otherwise specified)

Load Transient, 1mA – 1A,  $V_{IN}=5\text{V}$ ,  $V_{OUT}=3.3\text{V}$

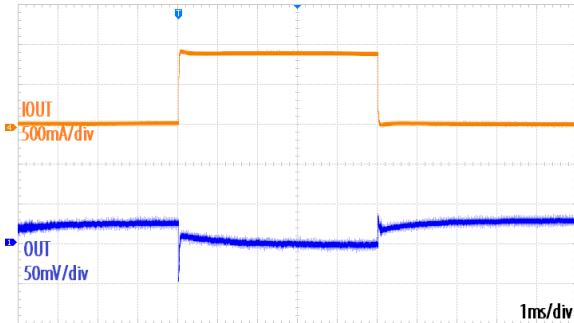

Line Transient,  $V_{IN}=3.9\text{V} - 5\text{V}$ ,  $I_{OUT}=1\text{mA}$ ,  $V_{OUT}=3.3\text{V}$

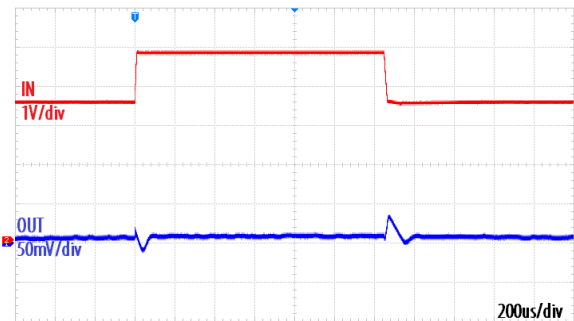

Load Regulation,  $V_{IN}=5\text{V}$ ,  $V_{OUT}=3.3\text{V}$

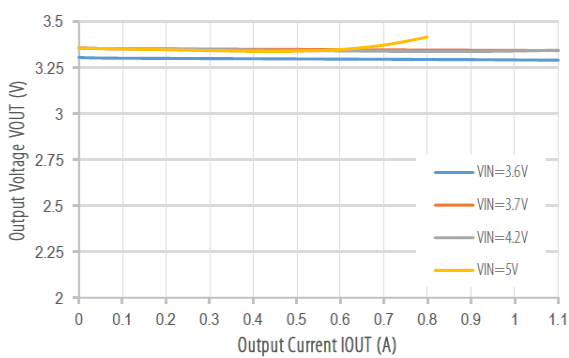

Power Supply Rejection vs. Output Current  
 $V_{OUT}=1.8\text{V}$ ,  $C_{IN}=C_{OUT}=10\mu\text{F}$

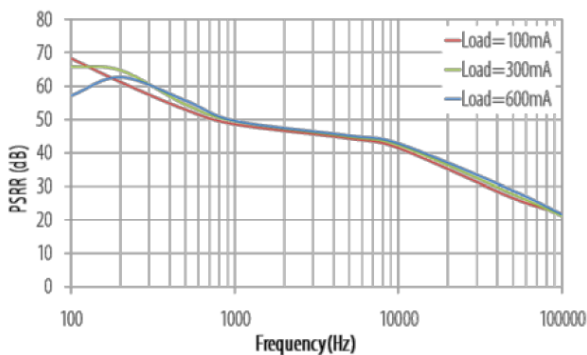

Load Transient, 1mA – 1A,  $V_{IN}=2.5\text{V}$ ,  $V_{OUT}=1.2\text{V}$

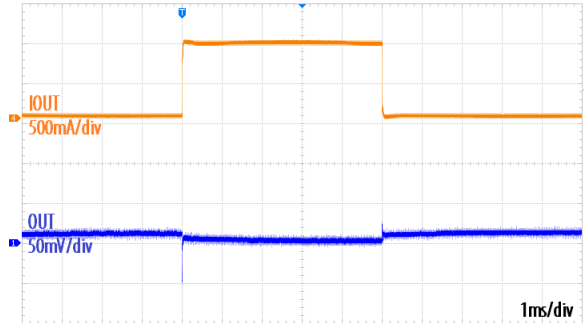

Line Transient,  $V_{IN}=2.2\text{V} - 3.2\text{V}$ ,  $I_{OUT}=1\text{mA}$ ,  $V_{OUT}=1.2\text{V}$

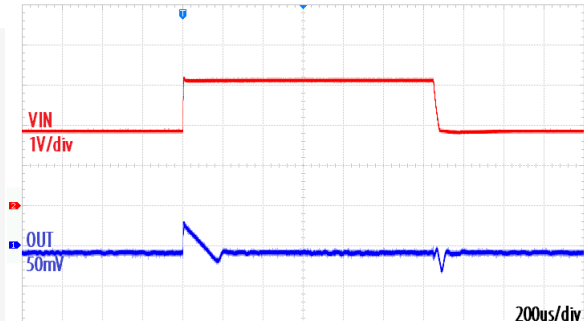

Line Regulation,  $V_{IN}=5\text{V}$ ,  $V_{OUT}=3.3\text{V}$

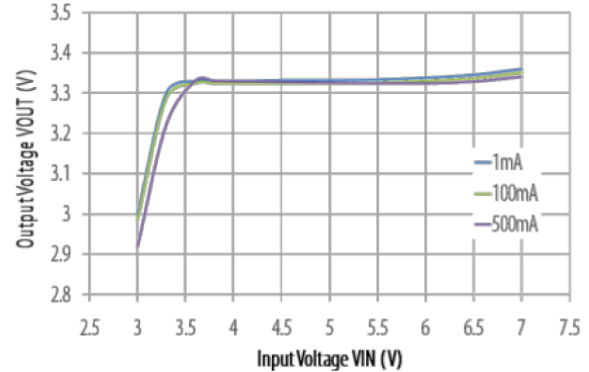

PSRR vs. Frequency and Output Current,  
 $V_{OUT}=3.3\text{V}$ ,  $C_{IN}=C_{OUT}=10\mu\text{F}$

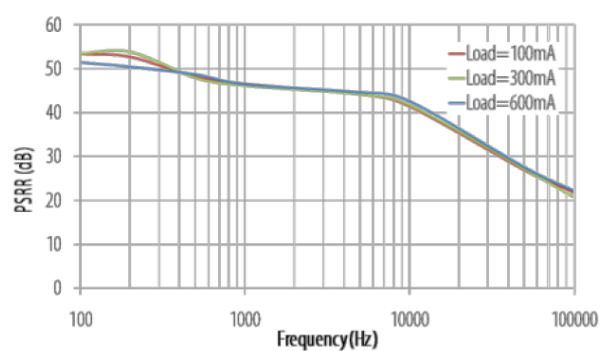

## TYPICAL PERFORMANCE CHARACTERISTICS CONT'D

( $T_A=25\text{ }^\circ\text{C}$ ,  $V_{IN}=5\text{V}$ ,  $C_{IN}=1\mu\text{F}$ ,  $C_{OUT}=1\mu\text{F}$ , unless otherwise specified)

Drop-out Voltage vs. Output Voltage,  $I_{OUT}=1\text{A}$

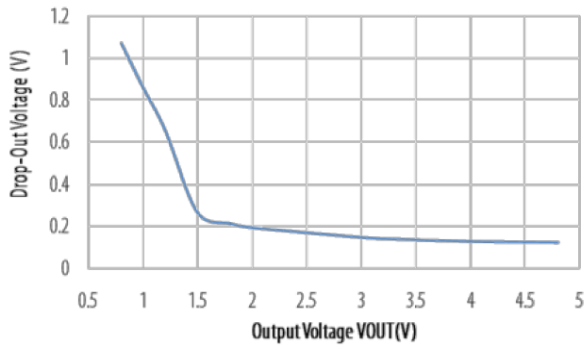

Quiescent Current over Temperature

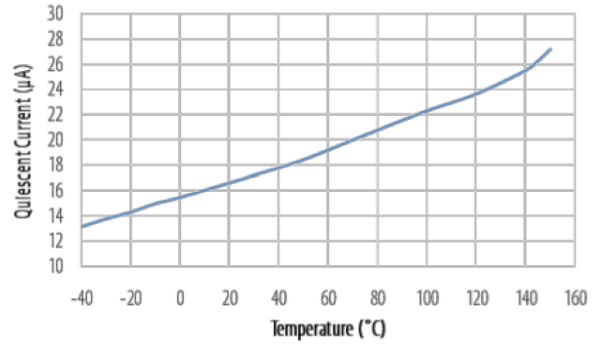

Shutdown Current over Temperature

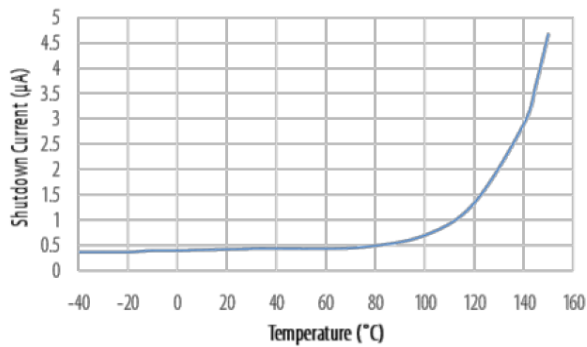

Current Limit vs. Temperature

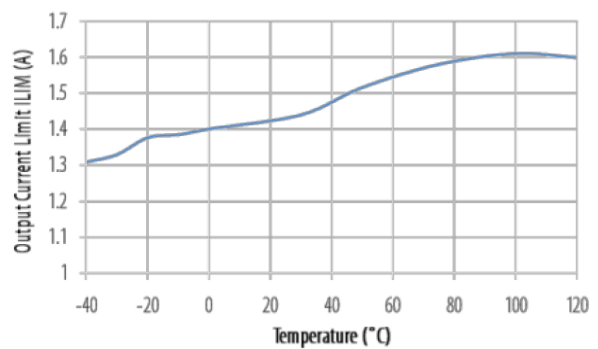

Output Voltage vs. Temperature,  $I_{OUT}=1\text{mA}$

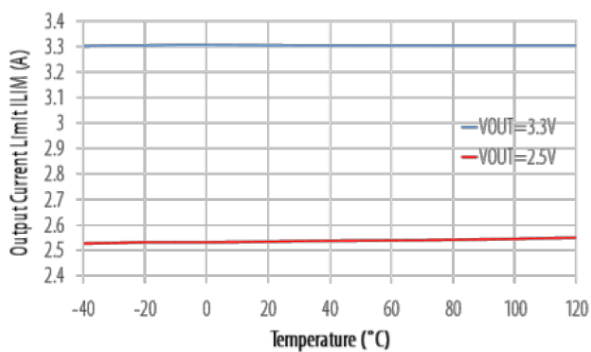

## FUNCTIONAL DESCRIPTION

The ETA5060 family of LDO regulators has been optimized for use in noise-sensitive equipments. The device features extremely low dropout voltages, high PSRR, low output noise, low quiescent current, and enable-input to reduce supply currents to less than 1µA when the regulator is turned off.

### Enable Sequence

ETA5060 is enabled when all below conditions happen. Otherwise, ETA5060 is in standby mode.

- ◆ EN pin voltage above Logic High level
- ◆ Junction Temperature is not at Over-Temperature Protection level.

Once all above conditions happen, ETA5060 enables LDO core.

ETA5060 is completed forced in shutdown mode when EN pin is at below  $V_{EN\_LO}$  that supply current is less than 1µA. Otherwise, part only shutdowns the  $V_{OUT}$  while other circuit still in operation.

### Output Current Limit and Foldback Current Limit

ETA5060 family features an internal current limit. In normal operation, the ETA5060 limits output current to approximately 1400mA. When current limiting engages, the output voltage scales back linearly until the over current condition ends.

In case output is in hard short conditions, ETA5060 also features an internal foldback limit that reduces the output current limit to a lower level, then reduce power dissipation ratings of the package.

### Stability

ETA5060 can be stable with very wide range of output capacitor, from 1µF to 10µF

### Over-Temperature Protection

Thermal protection disables the output when the junction temperature rises to approximately 160°C, allowing the device to cool down. When the junction temperature cools to approximately 130°C, the output circuitry is again enabled. Depending on power dissipation, thermal resistance, and ambient temperature, the thermal protection circuit may cycle on and off. This cycling limits regulator dissipation, protecting the device from damage as a result of overheating.

## APPLICATION INFORMATION

### External Output Voltage Setting

In external Output Voltage Setting Version selected, the ETA5060 regulator is programmed using an external resistor divider. The output voltage is calculated using below equation.

$$V_{OUT} = V_{REF} \times \left(1 + \frac{R_1}{R_2}\right)$$

Resistors  $R_1$  and  $R_2$  should be chosen for approximately 40-µA divider current. Lower value resistors can be used for improved noise performance, but the solution consumes more power. Higher resistors values can cause accuracy issues. The recommended design procedure is to choose  $R_2 = 20k\Omega$  to set the divider current at 40µA, then  $R_1$  is calculated using below equation.

$$R_1 = \left(\frac{V_{OUT}}{V_{REF}} - 1\right) \times R_2$$



## AVAILABLE PART NUMBER

Part Description	Part Number	Package	Mark	Pcs/Reel
Adjustable Output SOT89-5	ETA5060V0S8F	SOT89-5	SG0	1000
Fixed 1.5V Output SOT89-5	ETA5060V150S8F	SOT89-5	SG1	1000
Fixed 1.8V Output SOT89-5	ETA5060V180S8F	SOT89-5	SG2	1000
Fixed 2.5V Output SOT89-5	ETA5060V250S8F	SOT89-5	SG3	1000
Fixed 2.8V Output SOT89-5	ETA5060V280S8F	SOT89-5	SG4	1000
Fixed 2.85V Output SOT89-5	ETA5060V285S8F	SOT89-5	SG5	1000
Fixed 3.0V Output SOT89-5	ETA5060V300S8F	SOT89-5	SG6	1000
Fixed 3.3V Output SOT89-5	ETA5060V330S8F	SOT89-5	SG7	1000
Adjustable Output HFBP1.2x1.6-8	ETA5060V0HBI	HFBP1.2x1.6-8	SG0	3000
Fixed 1.5V Output HFBP1.2x1.6-8	ETA5060V150HBI	HFBP1.2x1.6-8	SG1	3000
Fixed 1.8V Output HFBP1.2x1.6-8	ETA5060V180HBI	HFBP1.2x1.6-8	SG2	3000
Fixed 2.5V Output HFBP1.2x1.6-8	ETA5060V250HBI	HFBP1.2x1.6-8	SG3	3000
Fixed 2.8V Output HFBP1.2x1.6-8	ETA5060V280HBI	HFBP1.2x1.6-8	SG4	3000
Fixed 2.85V Output HFBP1.2x1.6-8	ETA5060V285HBI	HFBP1.2x1.6-8	SG5	3000
Fixed 3.0V Output HFBP1.2x1.6-8	ETA5060V300HBI	HFBP1.2x1.6-8	SG6	3000
Fixed 3.3V Output HFBP1.2x1.6-8	ETA5060V330HBI	HFBP1.2x1.6-8	SG7	3000
Adjustable Output DFN1.2x1.6-8	ETA5060V0DBI	DFN1.2x1.6-8	SG0	3000
Fixed 1.5V Output DFN1.2x1.6-8	ETA5060V150DBI	DFN1.2x1.6-8	SG1	3000
Fixed 1.8V Output DFN1.2x1.6-8	ETA5060V180DBI	DFN1.2x1.6-8	SG2	3000
Fixed 2.5V Output DFN1.2x1.6-8	ETA5060V250DBI	DFN1.2x1.6-8	SG3	3000
Fixed 2.8V Output DFN1.2x1.6-8	ETA5060V280DBI	DFN1.2x1.6-8	SG4	3000
Fixed 2.85V Output DFN1.2x1.6-8	ETA5060V285DBI	DFN1.2x1.6-8	SG5	3000
Fixed 3.0V Output DFN1.2x1.6-8	ETA5060V300DBI	DFN1.2x1.6-8	SG6	3000
Fixed 3.3V Output DFN1.2x1.6-8	ETA5060V330DBI	DFN1.2x1.6-8	SG7	3000
Adjustable Output DFN2x2-6	ETA5060V0D2G	DFN2x2-6	SG0	3000
Adjustable Output DFN2x2-8	ETA5060V0D2I	DFN2x2-8	SG0	3000
Fixed 1.5V Output DFN2x2-8	ETA5060V150D2I	DFN2x2-8	SG1	3000
Fixed 1.8V Output DFN2x2-8	ETA5060V180D2I	DFN2x2-8	SG2	3000
Fixed 2.5V Output DFN2x2-8	ETA5060V250D2I	DFN2x2-8	SG3	3000
Fixed 2.8V Output DFN2x2-8	ETA5060V280D2I	DFN2x2-8	SG4	3000
Fixed 2.85V Output DFN2x2-8	ETA5060V285D2I	DFN2x2-8	SG5	3000
Fixed 3.0V Output DFN2x2-8	ETA5060V300D2I	DFN2x2-8	SG6	3000
Fixed 3.3V Output DFN2x2-8	ETA5060V330D2I	DFN2x2-8	SG7	3000

PACKAGE OUTLINE

Package: SOT89-5

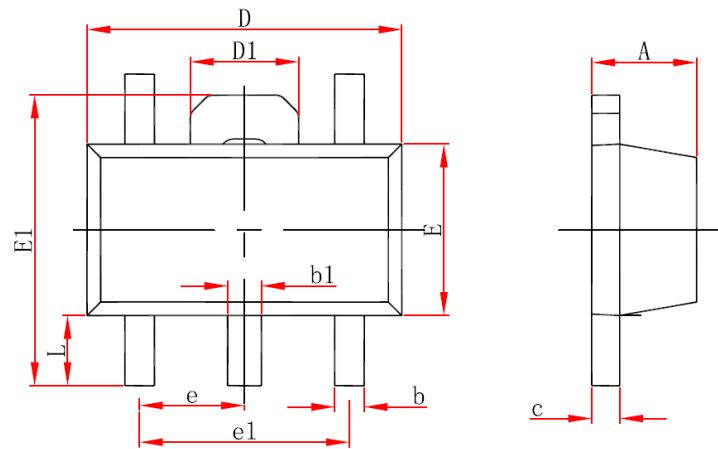

Symbol	Dimensions In Millimeters		Dimensions In Inches	
	Min.	Max.	Min.	Max.
A	1.400	1.600	0.055	0.063
b	0.320	0.520	0.013	0.020
b1	0.380	0.580	0.015	0.023
c	0.350	0.440	0.014	0.017
D	4.400	4.600	0.173	0.181
D1	1.550 REF.		0.061 REF.	
E	2.300	2.600	0.091	0.102
E1	3.940	4.250	0.155	0.167
e	1.500 TYP.		0.060 TYP.	
e1	3.000 TYP.		0.118 TYP.	
L	0.900	1.200	0.035	0.047

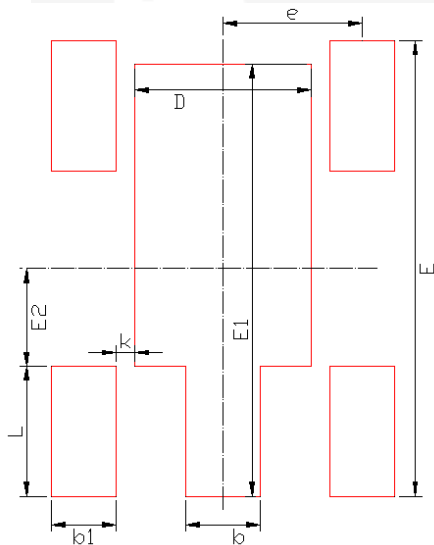

Dimensions	Value (in mm)
D	1.9
E	4.9
E1	4.65
E2	1.05
e	1.5
b	0.8
b1	0.7
L	1.4
k	0.2 ( $\geq 0.2$ )

RECOMMENDED LAND PATTERN

## PACKAGE OUTLINE

Package: HFBP1.2x1.6-8

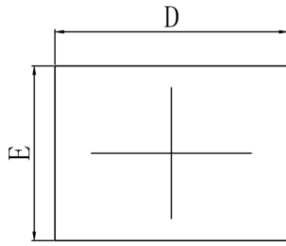

TOP VIEW

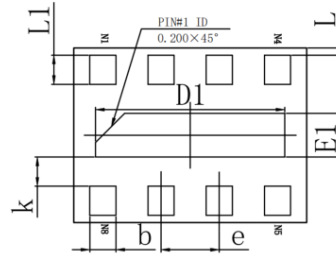

BOTTOM VIEW

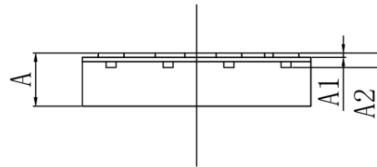

SIDE VIEW

Symbol	Dimensions In Millimeters		Dimensions In Inches	
	Min.	Max.	Min.	Max.
A	0.320	0.420	0.013	0.017
A1	0.000	0.050	0.000	0.002
A2	0.100REF.		0.004REF.	
D	1.550	1.650	0.061	0.065
E	1.150	1.250	0.045	0.049
D1	1.250	1.350	0.049	0.053
E1	0.250	0.350	0.010	0.014
b	0.130	0.230	0.005	0.009
e	0.400BSC.		0.016BSC.	
k	0.200REF.		0.008REF.	
L	0.500REF.		0.020REF.	
L1	0.150	0.250	0.006	0.010

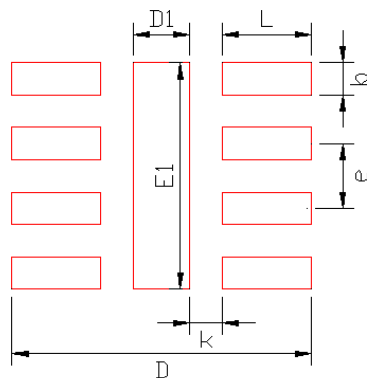

RECOMMENDED LAND PATTERN

Dimensions	Value (in mm)
D	1.85
D1	0.35
E1	1.4
L	0.55
b	0.2
e	0.4
k	0.2

## PACKAGE OUTLINE

Package: DFN1.2x1.6-8

From assembly house 1:

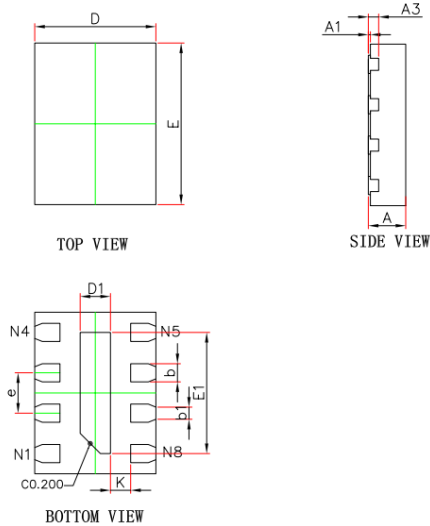

Symbol	Dimensions In Millimeters		Dimensions In Inches	
	Min.	Max.	Min.	Max.
A	0.320	0.400	0.013	0.016
A1	0.000	0.050	0.000	0.002
A3	0.102REF.		0.004REF.	
D	1.100	1.300	0.043	0.051
E	1.500	1.700	0.059	0.067
D1	0.200	0.400	0.008	0.016
E1	1.100	1.300	0.043	0.051
k	0.200 REF.		0.008 REF.	
b	0.130	0.230	0.005	0.009
b1	0.120REF.		0.005REF.	
e	0.400BSC.		0.016BSC.	
L	0.200	0.300	0.008	0.012

From assembly house 2:

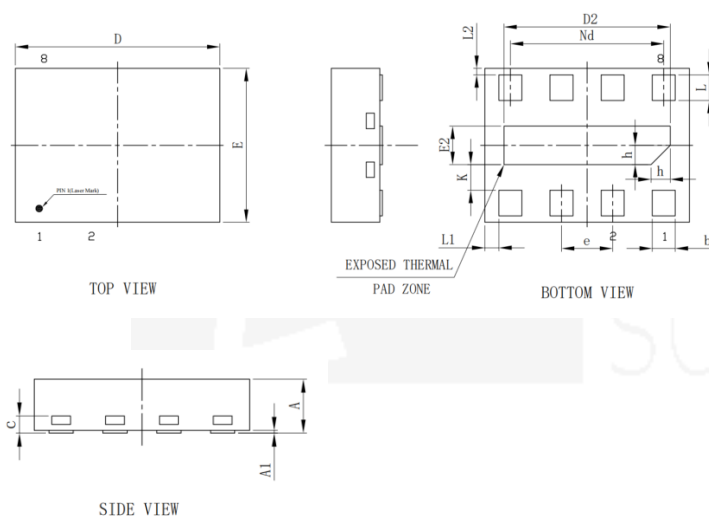

SYMBOL	MILLIMETER		
	MIN	NOM	MAX
A	0.35	-	0.40
A1	0	0.02	0.05
b	0.13	0.18	0.23
c	0.127REF		
D	1.55	1.60	1.65
D2	1.25	1.30	1.35
e	0.40BSC		
Nd	1.20BSC		
E	1.15	1.20	1.25
E2	0.25	0.30	0.35
L	0.15	0.20	0.25
L1	0.06	0.11	0.16
L2	0.05REF		
h	0.10	0.15	0.20
K	0.15	0.20	0.25

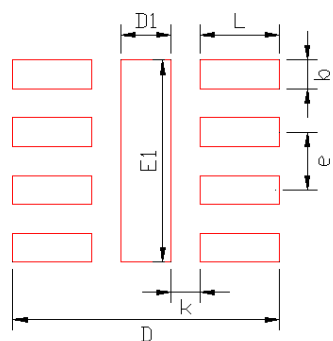

RECOMMENDED LAND PATTERN

Dimensions	Value (in mm)
D	1.85
D1	0.35
E1	1.4
L	0.55
b	0.2
e	0.4
k	0.2

PACKAGE OUTLINE

Package: DFN2x2-6

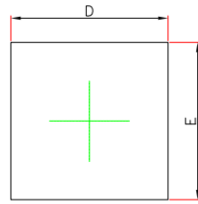

TOP VIEW

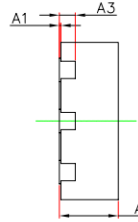

SIDE VIEW

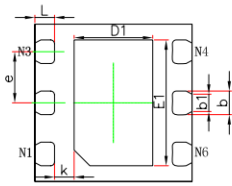

BOTTOM VIEW

Symbol	Dimensions In Millimeters		Dimensions In Inches	
	Min.	Max.	Min.	Max.
A	0.700	0.800	0.028	0.031
A1	0.000	0.050	0.000	0.002
A3	0.203REF.		0.008REF.	
D	1.900	2.100	0.075	0.083
E	1.900	2.100	0.075	0.083
D1	0.900	1.100	0.035	0.043
E1	1.500	1.700	0.059	0.067
k	0.250 REF.		0.010REF.	
b	0.250	0.350	0.010	0.014
b1	0.220 REF.		0.009 REF.	
e	0.650BSC.		0.026BSC.	
L	0.174	0.326	0.007	0.013

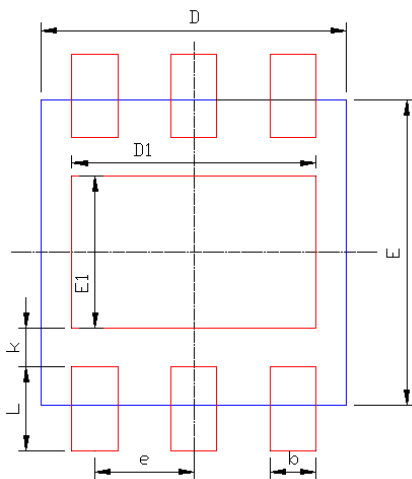

RECOMMENDED LAND PATTERN

Dimensions	Value (in mm)
D	2
E	2
D1	1.6
E1	1
e	0.65
b	0.3
L	0.55
k	0.25 ( $\geq 0.2$ )

## PACKAGE OUTLINE

Package: DFN2x2-8

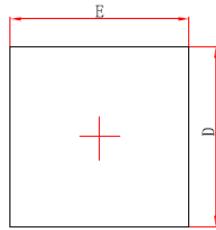

Top View

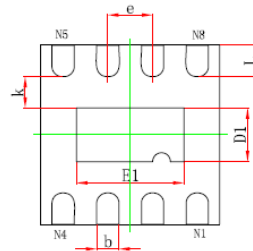

Bottom View

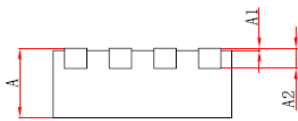

Side View

Symbol	Dimensions In Millimeters		Dimensions In Inches	
	Min.	Max.	Min.	Max.
A	0.700/0.800	0.800/0.900	0.028/0.031	0.031/0.035
A1	0.000	0.050	0.000	0.002
A2	0.153	0.253	0.006	0.010
D	1.900	2.100	0.075	0.083
E	1.900	2.100	0.075	0.083
D1	0.500	0.700	0.020	0.028
E1	1.100	1.300	0.043	0.051
k	0.200MIN.		0.008MIN.	
b	0.180	0.300	0.007	0.012
e	0.500TYP.		0.020TYP.	
L	0.250	0.450	0.010	0.018

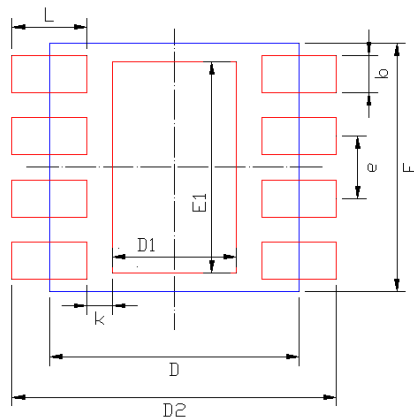

RECOMMENDED LAND PATTERN

Dimensions	Value (in mm)
D	2
E	2
D1	1
E1	1.7
D2	2.6
e	0.5
b	0.3
k	0.2 ( $\geq 0.2$ )
L	0.6

## TAPE AND REEL INFORMATION

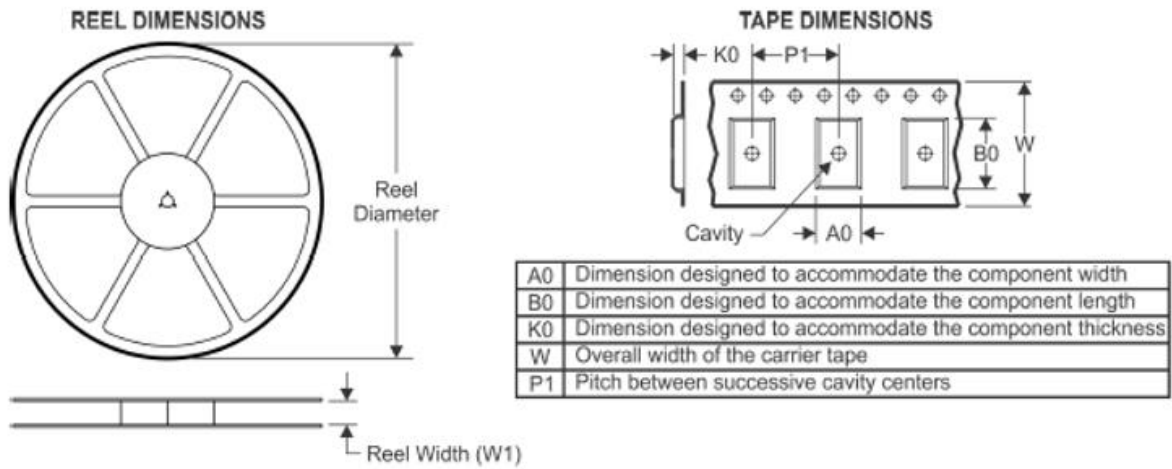

### QUADRANT ASSIGNMENTS FOR PIN 1 ORIENTATION IN TAPE

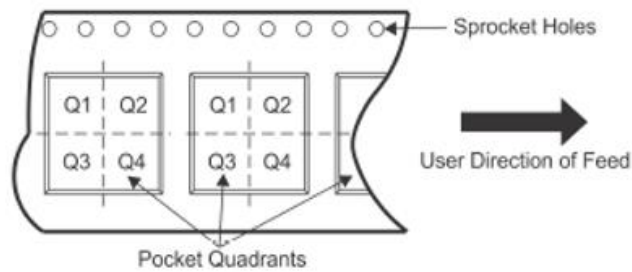

Device	Package Type	Pins	SPQ	Reel Diameter (mm)	Reel Width W1 (mm)	A0 (mm)	B0 (mm)	K0 (mm)	P1 (mm)	W (mm)	Pin1 Quadrant
ETA5060VXXS8F	SOT89-5	5	1000	180	13.2	4.75	4.75	1.8	8	12	Q3
ETA5060VXXHBI	HFBP1.2x1.6-8	8	3000	180	9.5	1.4	1.85	0.5	4	8	Q1
ETA5060VXXDBI	DFN1.2x1.6-8	8	3000	180	9.5	1.4	1.85	0.5	4	8	Q1
ETA5060V0D2G	DFN2x2-6	6	3000	180	9.5	2.3	2.3	1.1	4	8	Q1
ETA5060VXXD2I	DFN2x2-8	8	3000	180	9.5	2.3	2.3	1.1	4	8	Q1