

## 2MHz, 4A, COT Synchronous Step-down Converter in SOT563

### DESCRIPTION

The ETA3521 is a high-efficiency, DC-to-DC step-down switching regulator, capable of delivering up to 4A of output current. The devices operate from an input voltage range of 2.5V to 6.0V and provide output voltages from 0.6V to VIN, making the ETA3521 ideal for low voltage power conversions. ETA3521 adopts an adaptive COT control scheme that enables very fast transient response and provides a very smooth transition when the output varies from light load to heavy load. During light load, ETA3521 goes into a PFM mode that saves switching loss to achieve a high efficiency. The adaptive COT control also maintains a constant switching frequency across line and load. Running at a fixed frequency of 2MHz allows the use of small inductance value and low DCR inductors, thereby achieving a higher efficiency. Other external components, such as ceramic input and output caps, can also be small due to higher switching frequency, while maintaining exceptional low-noise output voltages. Internal soft-start control circuitry reduces inrush current. Short-circuit and thermal-overload protection improves design reliability. ETA3521 is available in a tiny SOT563 package.

### FEATURES

- ◆ Up to 95% Efficiency
- ◆ Up to 4A Max Output Current
- ◆ Adaptive COT Control
- ◆ Ultra-fast Load Transient Response
- ◆ 2MHz Frequency
- ◆ High Efficiency PFM Mode at Light Load
- ◆ 50uA Quiescent Current
- ◆ 1% Feedback Accuracy
- ◆ Adjustable Output Voltage from 0.6V
- ◆ Cycle-by-cycle Over Current Protection
- ◆ Short Circuit Protection with Hiccup Mode
- ◆ Stable with Low-ESR Output Ceramic Capacitors
- ◆ Available in SOT563 Package

### APPLICATIONS

- ◆ LCD TV
- ◆ Set Top Box
- ◆ IP CAM

### TYPICAL APPLICATION

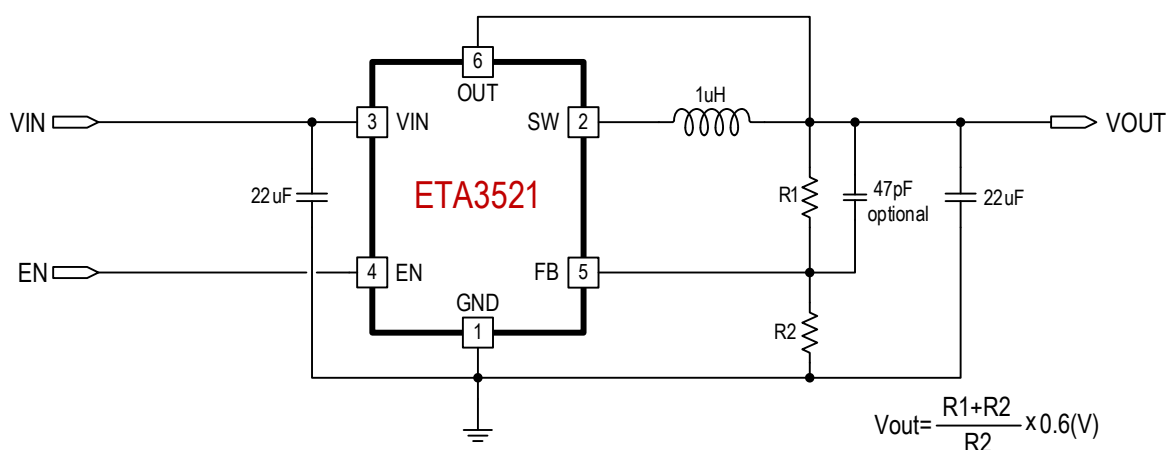

### ORDERING INFORMATION

PART No.	PACKAGE	TOP MARK	Pcs/Reel
ETA3521FSG	SOT563	CBYW	5000

## PIN CONFIGURATION

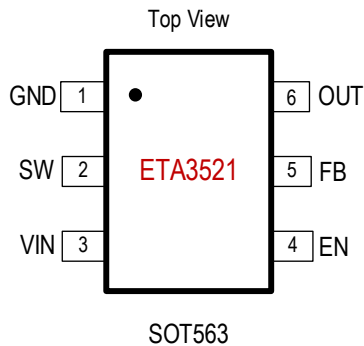

## ABSOLUTE MAXIMUM RATINGS

(Note: Exceeding these limits may damage the device. Exposure to absolute maximum rating conditions for long periods may affect device reliability.)

VIN, FB, EN, OUT, SW Voltage .....	-0.3V to 6.5V
Operating Temperature Range .....	-40°C to 85°C
Storage Temperature Range .....	-55°C to 150°C
Thermal Resistance $\theta_{JA}$ $\theta_{JC}$	
SOT563.....	80.....50..... °C/W
Lead Temperature (Soldering 10sec) .....	260°C
ESD HBM (Human Body Mode) .....	4KV
ESD CDM (Charged Device Mode) .....	1KV

## ELECTRICAL CHARACTERISTICS

(VIN = 5.0V, unless otherwise specified. Typical values are at TA = 25°C.)

PARAMETER	CONDITIONS	MIN	TYP	MAX	UNIT
Input Voltage Range		2.5		6.0	V
Input UVLO	Rising, Hysteresis=300mV	2.3	2.4	2.5	V
Input OVP	Rising, Hysteresis=0.25V	6.0	6.35	6.7	V
Input Supply Current	VFB=0.65V, no switching		50	100	µA
Input Shutdown Current			0	1	µA
FB Voltage	2.5V ≤ VIN ≤ 6.0V	0.594	0.6	0.606	V
FB Input Current			0	1	µA
Output Voltage Range		0.6		VIN	V
Load Regulation			0.7		%/A
Line Regulation	VIN=2.7V to 5.5V		0.2		%/V
Switching Frequency		1.5	2	2.5	MHz
Soft Start Time	VOUT Rising from 10% to 90%		0.5		mS
Short Circuit Hiccup Time	On Time		0.5		mS
	Off Time		3.5		mS
FB Hiccup Threshold			0.2		V
High Side Switch On Resistance			53	74	mΩ
Low Side Switch On Resistance			31	50	mΩ
High Side Current Limit		5.5	6		A
Low Side Current Limit		4.4	5		A
SW Leakage Current	VOUT=5.5V, VSW=0 or 5.5V, EN= GND			10	µA
EN Logic High Threshold	Rising	1.2			V
EN Logic Low Threshold	Falling			0.4	V
EN Input Current	VEN=2V			1	uA
Thermal Shutdown	Rising, Hysteresis =34°C		150		°C

## PIN DESCRIPTION

PIN #	NAME	DESCRIPTION
1	GND	Ground
2	SW	Inductor Connection. Connect an inductor Between SW and the regulator output.
3	VIN	Supply Voltage. Bypass with a 22 $\mu$ F ceramic capacitor to GND
4	EN	Enable pin. EN is high voltage level to enable. For automatic start-up, connect EN pin to VIN pin with a pull-up resistor.
5	FB	Feedback Input. Connect an external resistor divider from the output to FB and GND to set $V_{OUT}$
6	OUT	Output pin. Bypass with a 22 $\mu$ F or larger ceramic capacitor closely between this pin and GND

## TYPICAL CHARACTERISTICS

(Typical values are with  $C_{ff}=47pF$ , at  $T_A = 25^\circ C$  unless otherwise specified.)

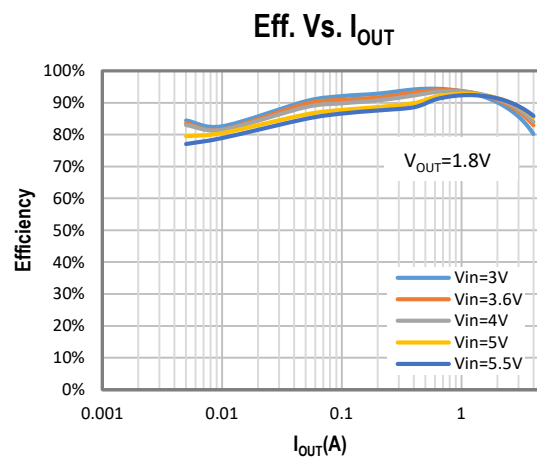
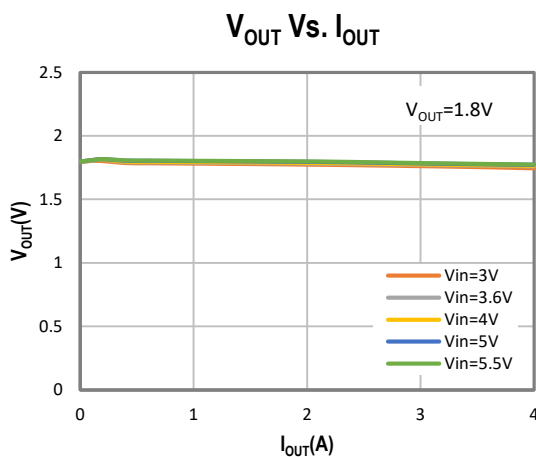
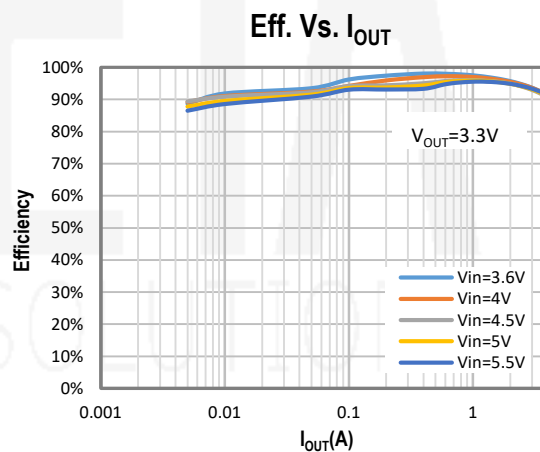
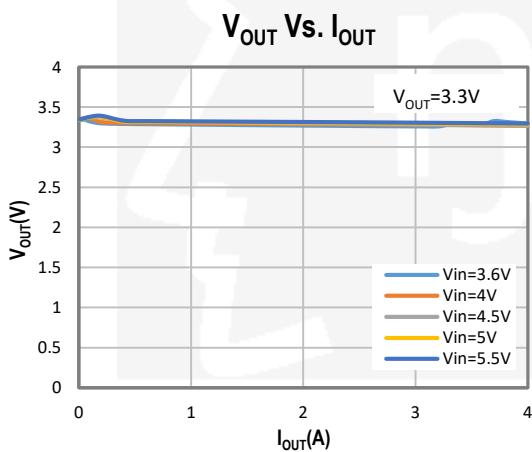

## TYPICAL CHARACTERISTICS (cont')

(Typical values are with  $C_{ff}=47\text{pF}$ , at  $T_A = 25^\circ\text{C}$  unless otherwise specified.)

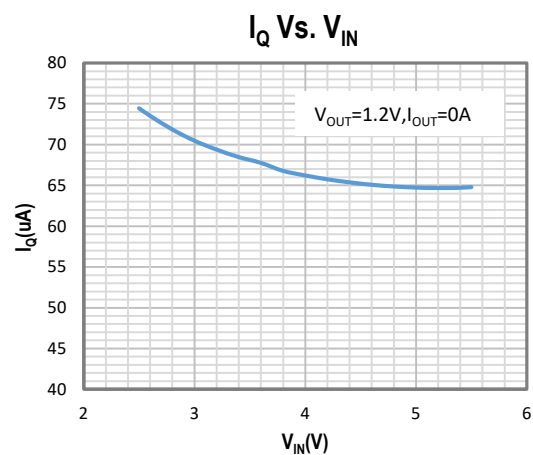
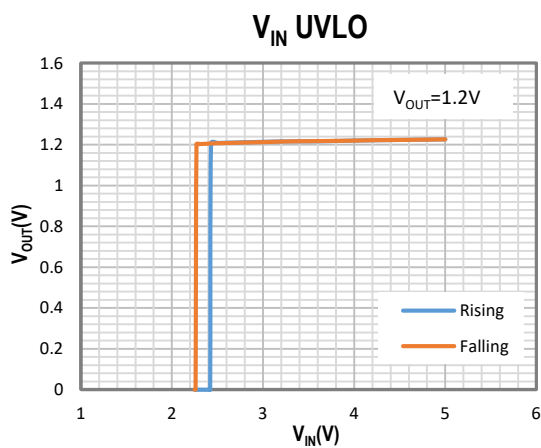
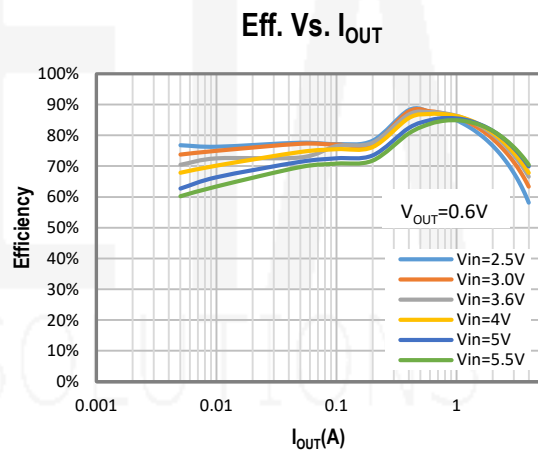
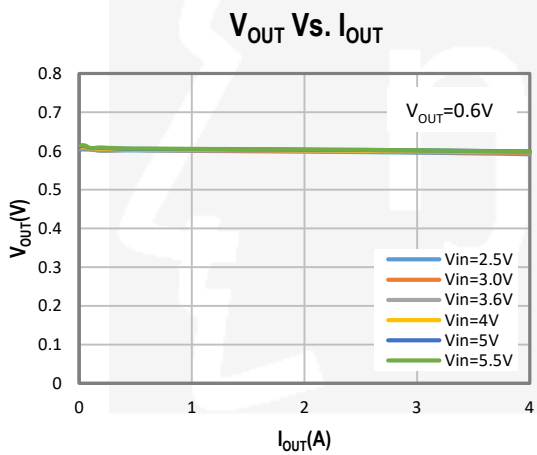
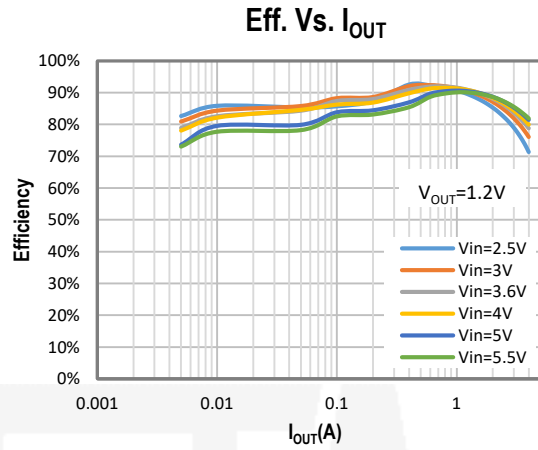
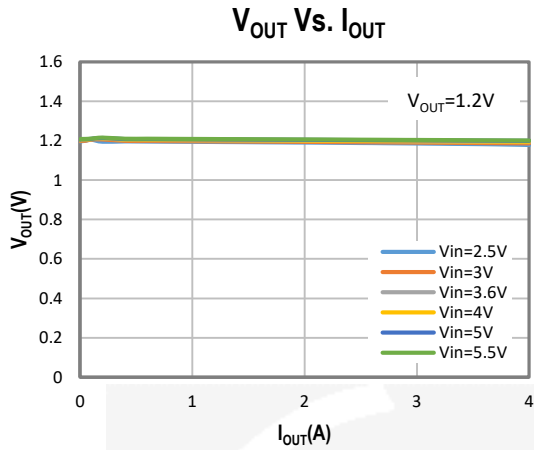

## TYPICAL CHARACTERISTICS (cont')

(Typical values are with  $C_{ff}=47\mu\text{F}$ , at  $T_A = 25^\circ\text{C}$  unless otherwise specified.)

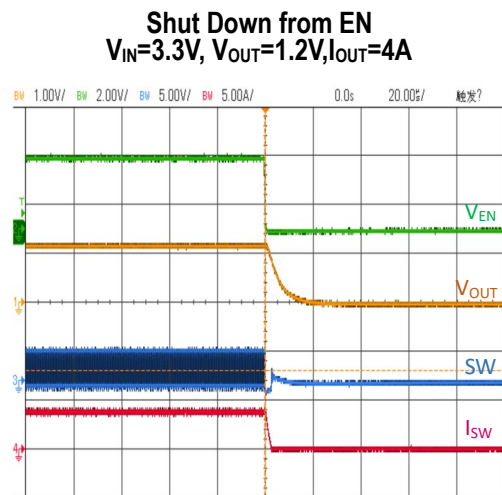
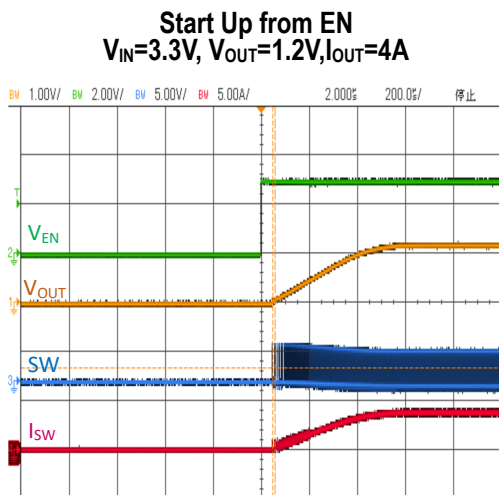
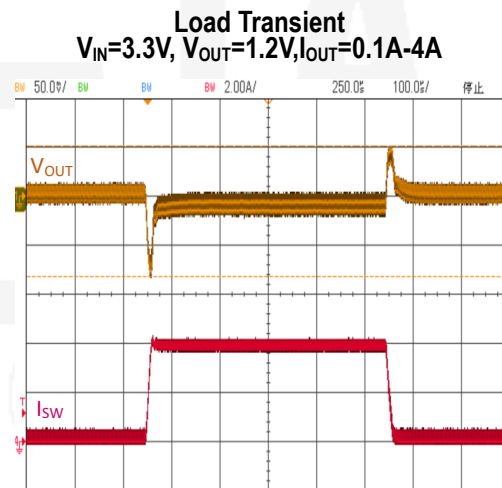
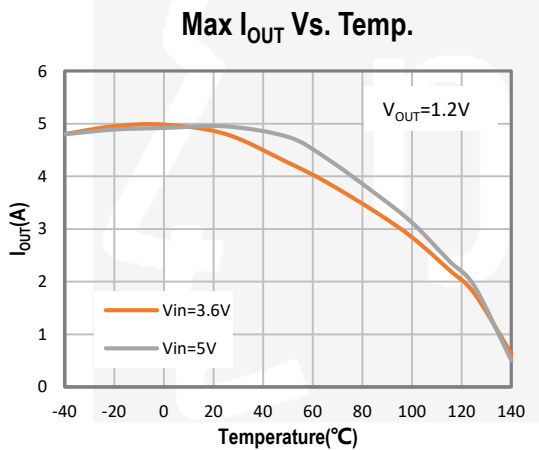
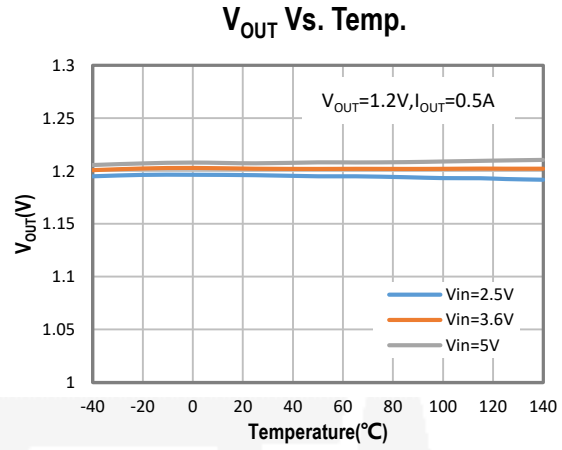
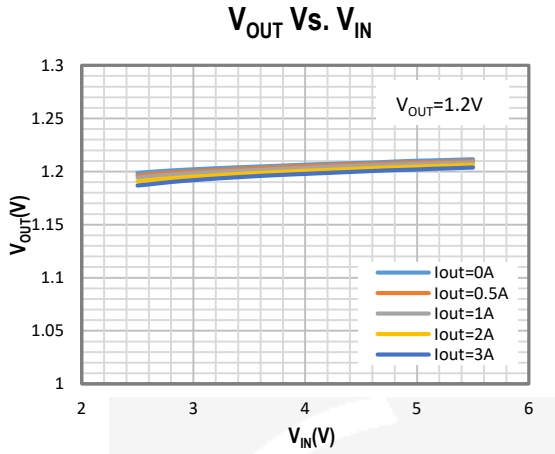

## TYPICAL CHARACTERISTICS (cont')

(Typical values are with  $C_{ff}=47\text{pF}$ , at  $T_A = 25^\circ\text{C}$  unless otherwise specified.)

**Start Up from VIN**  
 $V_{IN}=3.3\text{V}$ ,  $V_{OUT}=1.2\text{V}$ ,  $I_{OUT}=4\text{A}$

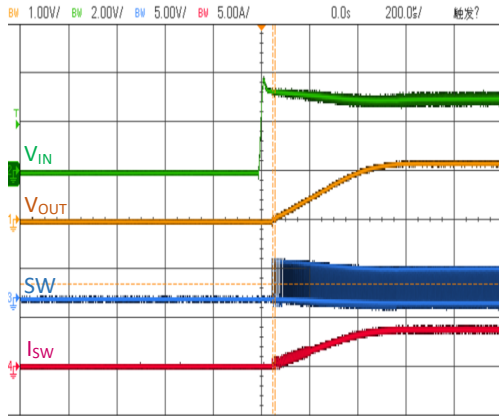

**Shut Down from VIN**  
 $V_{IN}=3.3\text{V}$ ,  $V_{OUT}=1.2\text{V}$ ,  $I_{OUT}=4\text{A}$

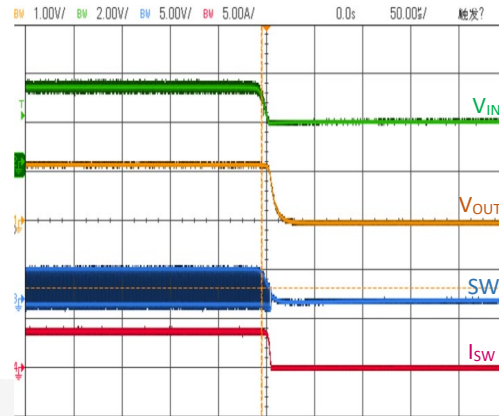

**Short Circuit Protection**

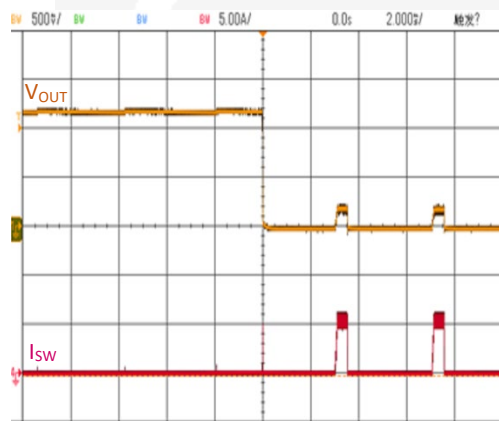

**Short Circuit Recovery**

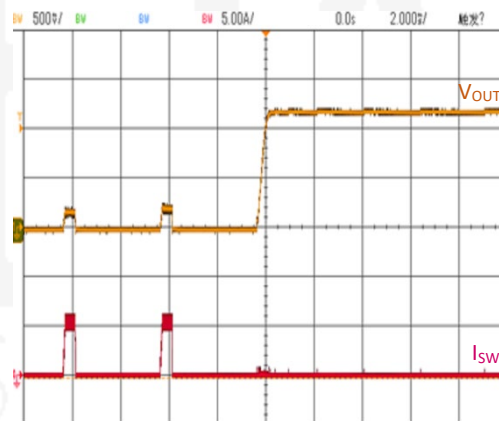

## FUNCTIONAL BLOCK DIAGRAM

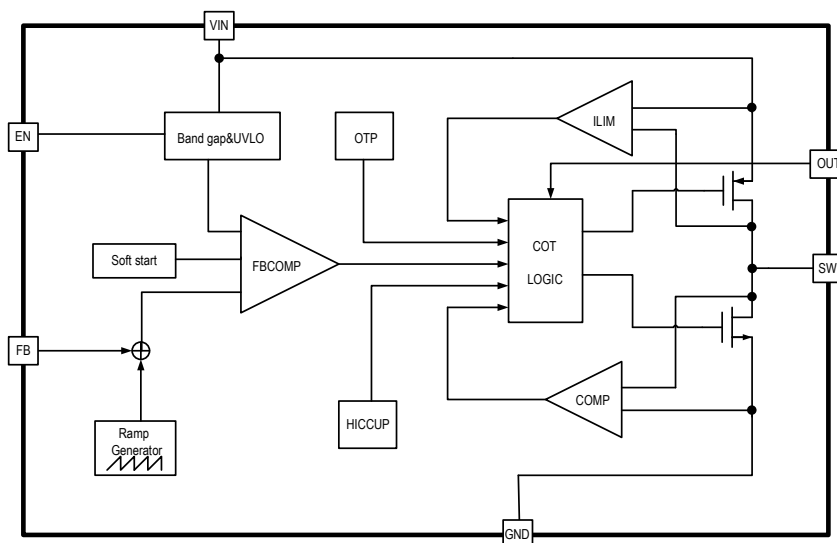

## FUNCTIONAL DESCRIPTION

The ETA3521 is a synchronous buck regulator that integrates the adaptive COT control, top and bottom switches on the same die to minimize the switching transition loss and conduction loss.

ETA3521 is a high-efficiency and high-frequency DC-to-DC step-down switching regulator, capable of delivering up to 4A of output current. It adopts an adaptive COT control scheme that enables very fast transient response and provides a very smooth transition when the output varies from light load to heavy load. It compares the sum of the FB voltage and a ripple voltage that mimics the voltage due to the output ESR and capacitance. The constant-on-time timer varies with line to achieve relative constant switching frequency across line.

### *Light Load Operation*

Traditionally, a fixed constant frequency PWM DC-DC regulator always switches even when the output load is small. When energy is shuffling back and forth through the power MOSFET, power is lost due to the finite  $R_{ds(on)}$  of the MOSFET and parasitic capacitances. At light load, this loss is prominent and efficiency is therefore very low. ETA3521 goes into a power save mode during light load, thereby extending the range of high efficiency operation.

### *Over Current Protection and Hiccup*

ETA3521 has a cycle-by-cycle over current limit for when the inductor current peak value is over the set current limit threshold. When the output voltage drop until FB falls below UV threshold (0.2V), the ETA3521 will enter hiccup mode. It will turn off the chip immediately for 3.5mS. After that, it will try to re-starts as normal for 0.5mS. After 0.5mS, if FB is still below UV threshold, then the chip enters hiccup mode again. If FB is higher than UV threshold, it will enter the normal mode.

### *Over-Temperature Protection*

Thermal protection disables the output when the junction temperature rises to approximately 150°C, allowing the device to cool down. When the junction temperature cools to approximately 115°C, the output circuitry is again enabled. Depending on power dissipation, thermal resistance, and ambient temperature, the thermal protection circuit may cycle on and off. This cycling limits regulator dissipation, protecting the device from damage as a result of overheating.

## APPLICATION INFORMATION

### *External Output Voltage Setting*

In external Output Voltage Setting Version selected, the ETA3521 regulator is programmed using an external resistor divider. The output voltage is calculated using below equation.

$$V_{OUT} = V_{REF} \times \left(1 + \frac{R_1}{R_2}\right)$$

Where:  $V_{REF} = 0.6V$  typically (the internal reference voltage)

Resistors R2 has to be between 1KOhm to 70KOhm and thus R1 is calculated by following equation.

$$R_1 = \left(\frac{V_{OUT}}{V_{REF}} - 1\right) \times R_2$$

## PCB LAYOUT GUIDE

Keep the power devices as close to the chip as possible to achieve the smallest power loop area, which leads to the best EMI performance; Cin is always placed nearest to Vin and GND

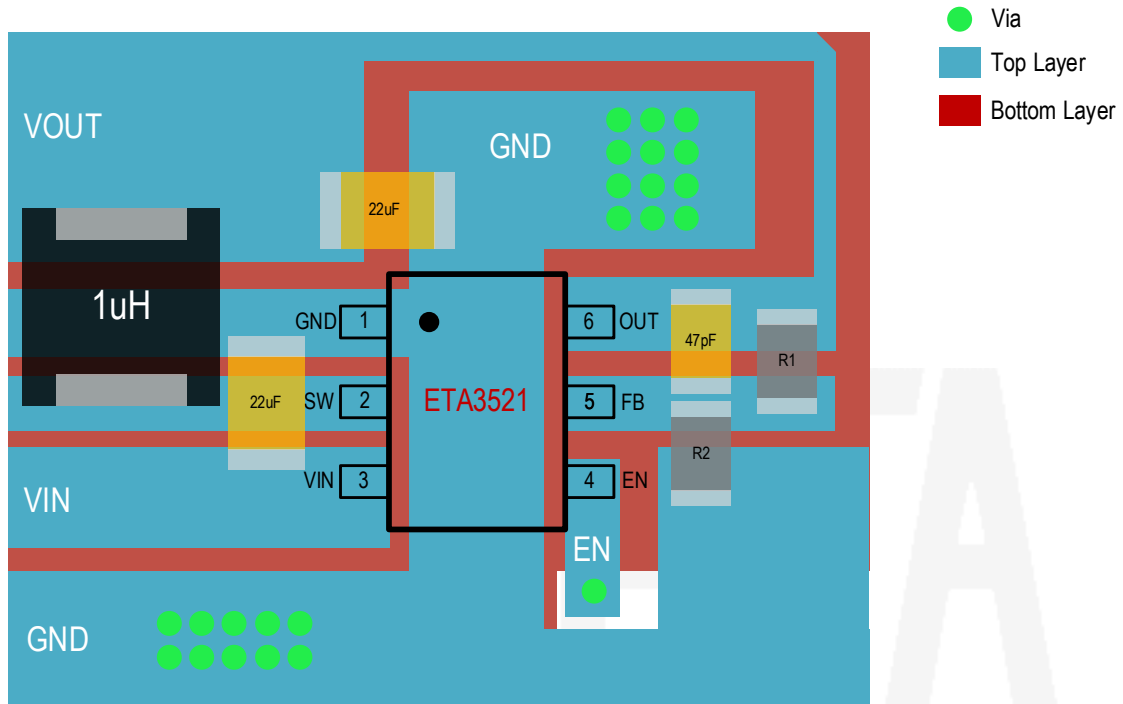



PACKAGE OUTLINE

Package: SOT563

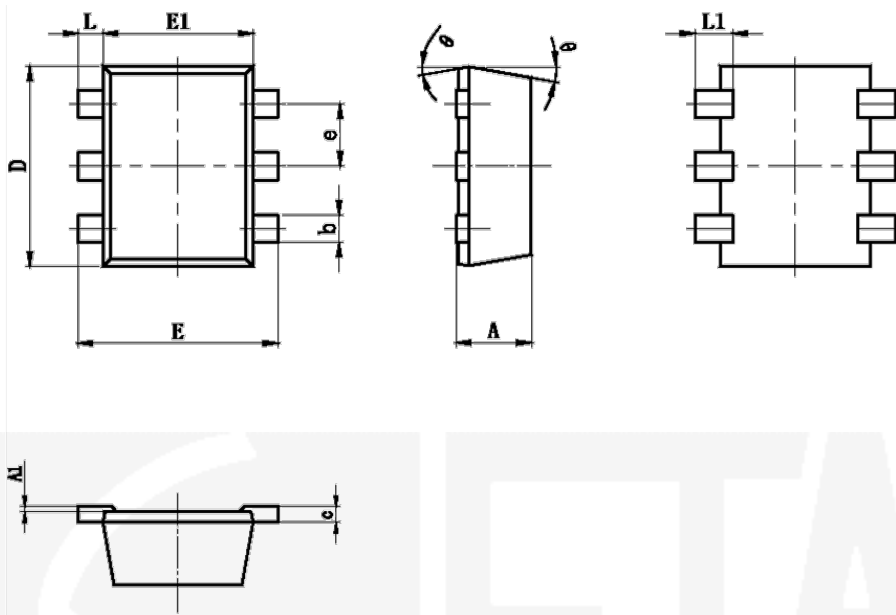

Symbol	Dimensions In Millimeters		Dimensions In Inches	
	Min.	Max.	Min.	Max.
A	0.525	0.600	0.021	0.024
A1	0.000	0.050	0.000	0.002
e	0.450	0.550	0.018	0.022
c	0.090	0.180	0.004	0.007
D	1.500	1.700	0.059	0.067
b	0.170	0.270	0.007	0.011
E1	1.100	1.300	0.043	0.051
E	1.500	1.700	0.059	0.067
L	0.100	0.300	0.004	0.012
L1	0.200	0.400	0.008	0.016
θ	9° REF.		9° REF.	

## TAPE AND REEL INFORMATION

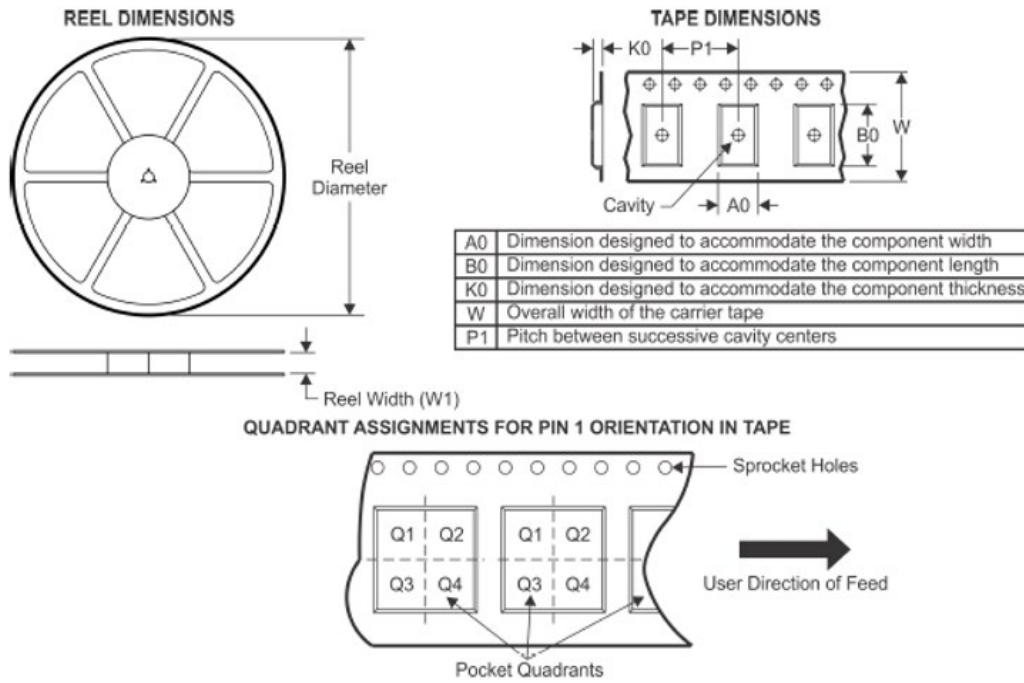

Device	Package Type	Pins	SPQ	Reel Diameter (mm)	Reel Width W1 (mm)	A0 (mm)	B0 (mm)	K0 (mm)	P1 (mm)	W (mm)	Pin1 Quadrant
ETA3521FSG	SOT563	6	5000	178	9.5	1.78	1.78	0.69	4	8	Q3