

18V, 2A, COT Synchronous Step-Down Converter in SOT23-6

DESCRIPTION

ETA8110 is a wide input range, high-efficiency and high-frequency DC-to-DC step-down switching regulator, capable of delivering up to 2A of output current. It adopts an adaptive COT control scheme that enables very fast transient response and provides a very smooth transition when the output varies from light load to heavy load. The adaptive COT control also maintains a constant switching frequency across line and load.

ETA8110 is available in SOT23-6 package.

APPLICATIONS

- ◆ LCD TV
- ◆ Set Top Box
- ◆ IP CAM

FEATURES

- ◆ Wide Input Voltage Range: 3.5V-18V
- ◆ Adaptive COT Control
- ◆ Forced PWM Mode
- ◆ Capable of Delivering 2A Output
- ◆ Ultra-fast Load Transient Response
- ◆ High Efficiency Synchronous Operation
- ◆ Low R_{ds(on)} Internal power FETs
- ◆ No External Compensation Needed
- ◆ Thermal Shutdown and UVLO
- ◆ Available in SOT23-6 Package
- ◆ RoHS Compliant

TYPICAL APPLICATION

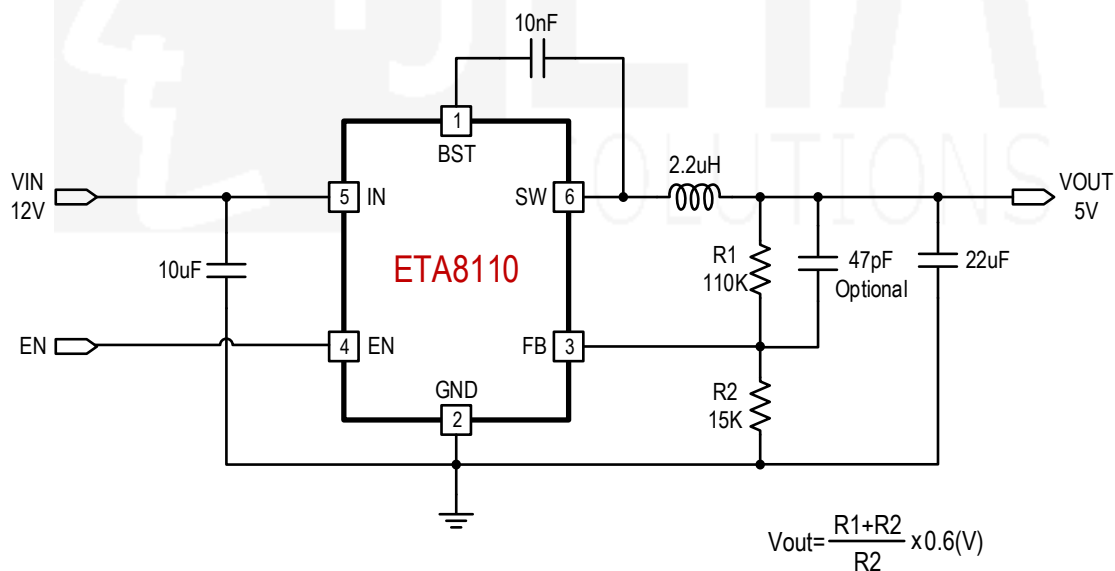

* R2 has to be between 1KOhm to 70KOhm

ORDERING INFORMATION

| PART No. | PACKAGE | TOP MARK | Pcs/Reel |
|------------|---------|----------|----------|
| ETA8110S2G | SOT23-6 | JG YW | 3000 |

PIN CONFIGURATION

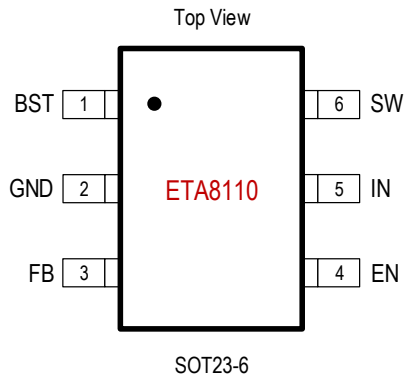

ABSOLUTE MAXIMUM RATINGS

(Note: Exceeding these limits may damage the device. Exposure to absolute maximum rating conditions for long periods may affect device reliability.)

| | |
|--|----------------------|
| IN, EN Voltage | -0.3V to 24V |
| SW Voltage..-0.3V (-5V for <10nS) to 19V (23V for <10nS) | |
| BST Voltage | -0.3V to SW+6V |
| FB Voltage | -0.3V to 6V |
| Junction Temperature | 150°C |
| Storage Temperature Range | -55°C to 150°C |
| Thermal Resistance θ_{JA} θ_{JC} | |
| SOT23-6..... | 180.....90..... °C/W |
| Lead Temperature (Soldering 10sec) | 260°C |

Recommended Operating Conditions

(Note: The device is not guaranteed to function outside its operating conditions.)

| | |
|----------------------------------|----------------|
| Ambient Temperature Range | -40°C to 85°C |
| Junction Temperature Range | -40°C to 125°C |

ELECTRICAL CHARACTERISTICS

($V_{IN} = 12V$, $V_{OUT} = 5V$, unless otherwise specified. Typical values are at $T_A = 25^\circ C$.)

| PARAMETER | CONDITIONS | MIN | TYP | MAX | UNIT |
|--------------------------------|--------------------------|-------|------|-------|------------|
| Input Voltage Range | | 3.5 | | 18 | V |
| Input UVLO | Rising, Hysteresis=350mV | | 3.4 | | V |
| Input Shutdown Current | | | 7 | 14 | μA |
| FB Voltage | | 0.591 | 0.6 | 0.609 | V |
| FB Input Current | | | 0 | 0.05 | μA |
| Switching Frequency | | | 1000 | | KHz |
| Maximum Duty Cycle | | | 92 | | % |
| Short Circuit Hiccup Time | On Time | | 2 | | mS |
| Short Circuit Hiccup Time | Off Time | | 6 | | mS |
| FB Hiccup Threshold | | | 0.2 | | V |
| High Side Switch On Resistance | | | 160 | | m Ω |
| Low Side Switch On Resistance | | | 95 | | m Ω |
| High Side Current Limit | | | 4.2 | | A |
| SW Leakage Current | $V_{IN}=V_{SW}=12V$ | | | 10 | μA |
| EN Rising Threshold | Rising | | 1.5 | | V |
| EN Falling Threshold | Falling | | 1.3 | | V |
| EN Input Current | $V_{EN}=2V$ | | 1 | | μA |
| Thermal Shutdown | Rising, Hysteresis =15°C | | 150 | | °C |

PIN DESCRIPTION

| PIN # | NAME | DESCRIPTION |
|-------|------|---|
| 1 | BST | Bootstrap pin. Connect a 10nF capacitor from this pin to SW |
| 2 | GND | Ground |
| 3 | FB | Feedback Input. Connect an external resistor divider from the output to FB and GND to set V_{OUT} |
| 4 | EN | Enable pin for the IC. Drive this pin high to enable the part, low or floating to disable. |
| 5 | IN | Supply Voltage. Bypass with a 10 μ F ceramic capacitor to GND |
| 6 | SW | Inductor Connection. Connect an inductor Between SW and the regulator output. |

TYPICAL CHARACTERISTICS

(Typical values are at $T_A = 25^\circ\text{C}$ unless otherwise specified.)

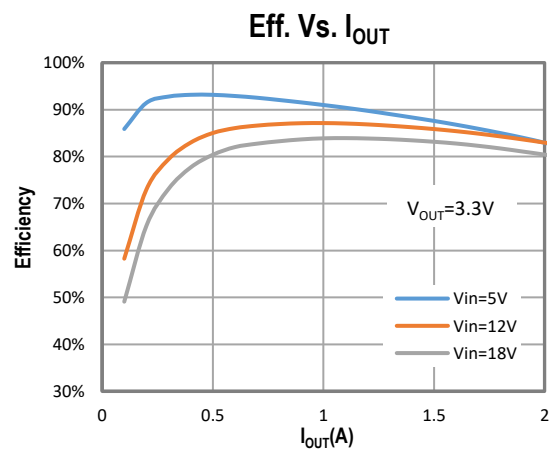
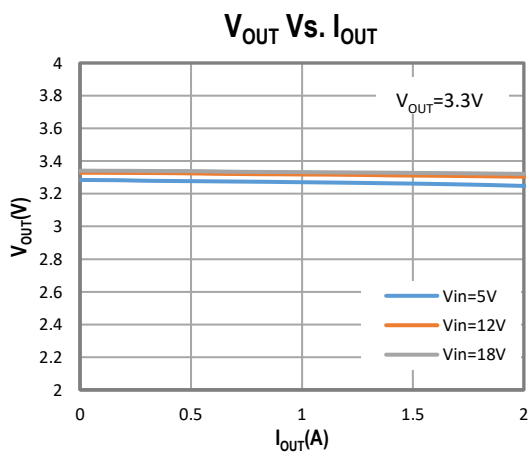
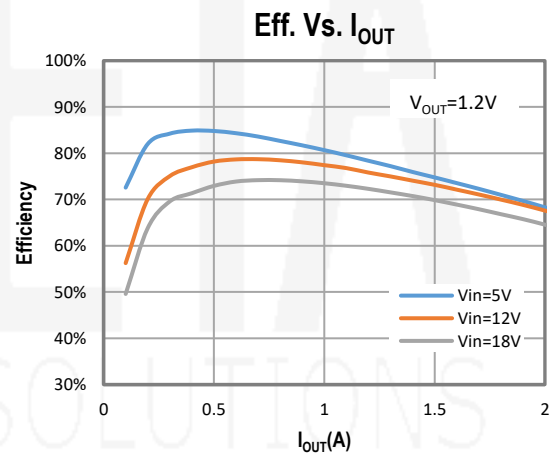
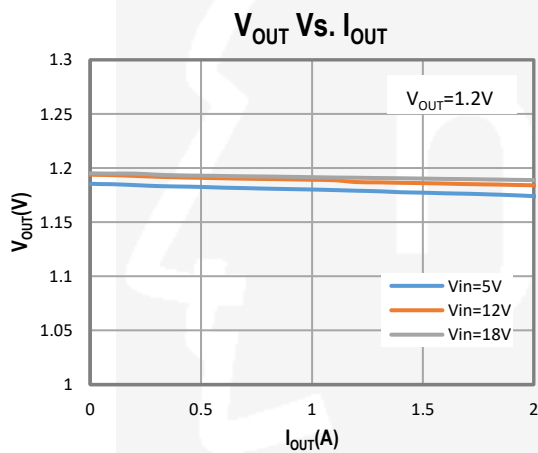

TYPICAL CHARACTERISTICS (cont')

(Typical values are at $T_A = 25^\circ\text{C}$ unless otherwise specified.)

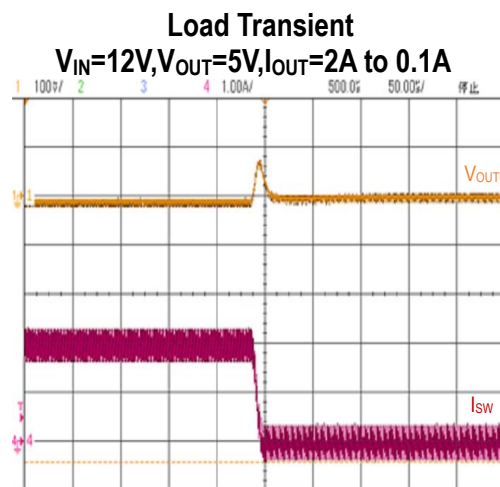
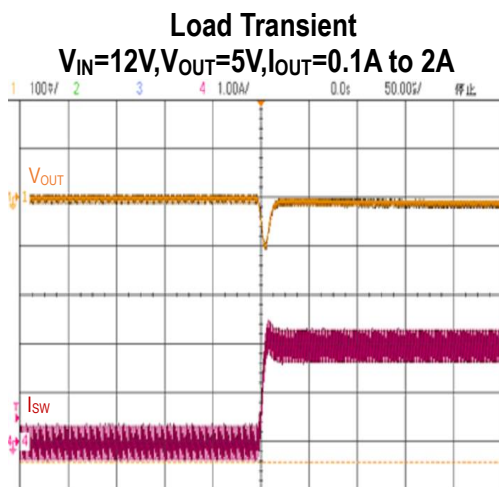
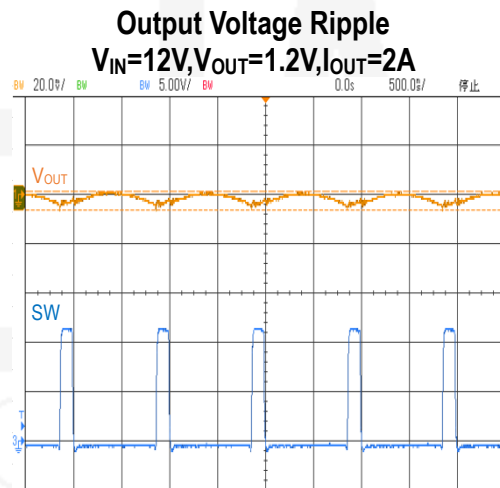
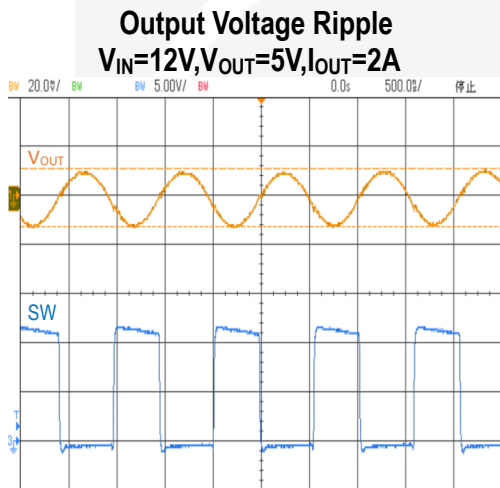
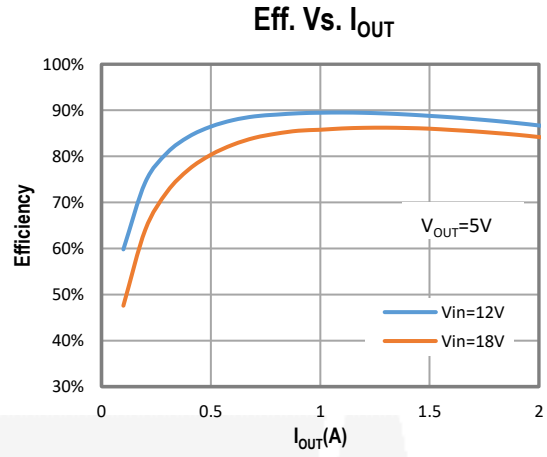
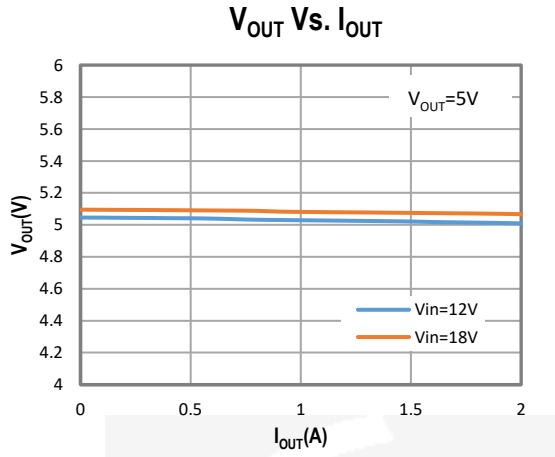

TYPICAL CHARACTERISTICS (cont')

(Typical values are at $T_A = 25^\circ\text{C}$ unless otherwise specified.)

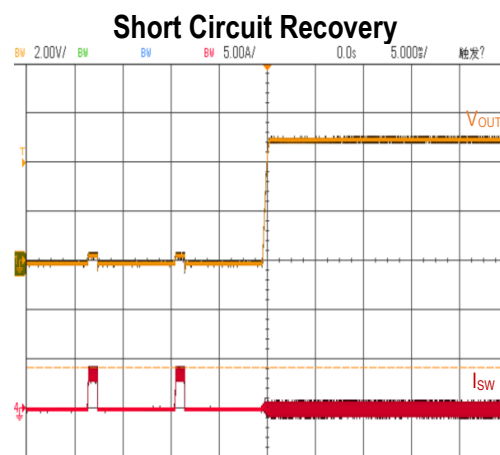
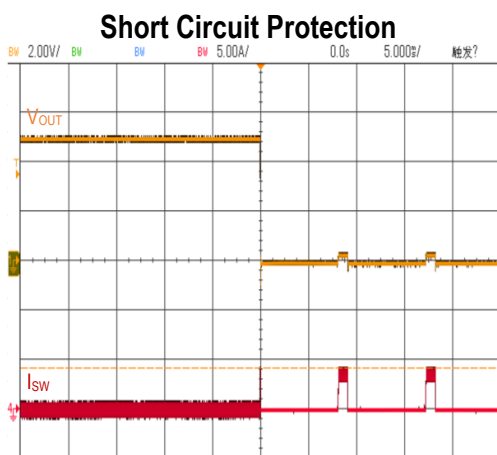
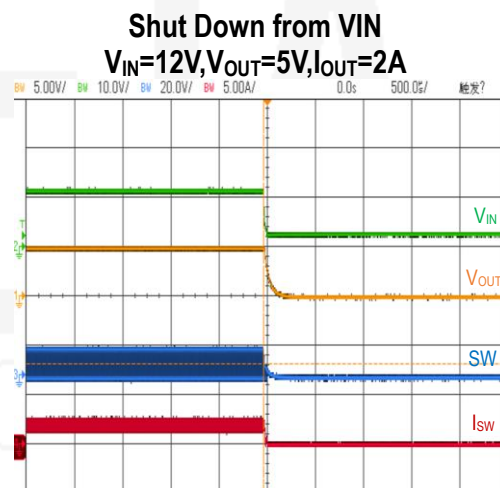
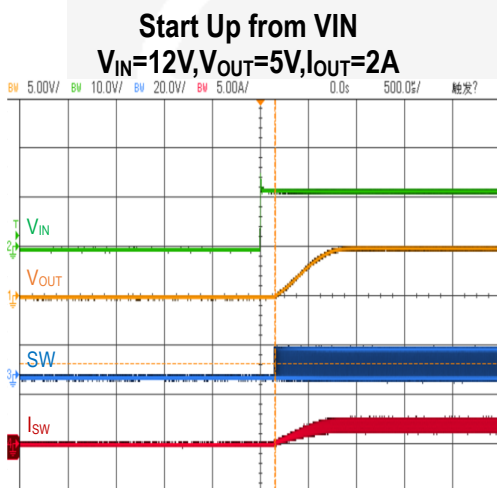
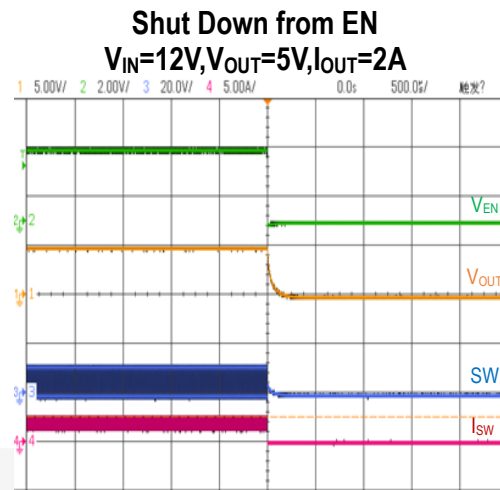
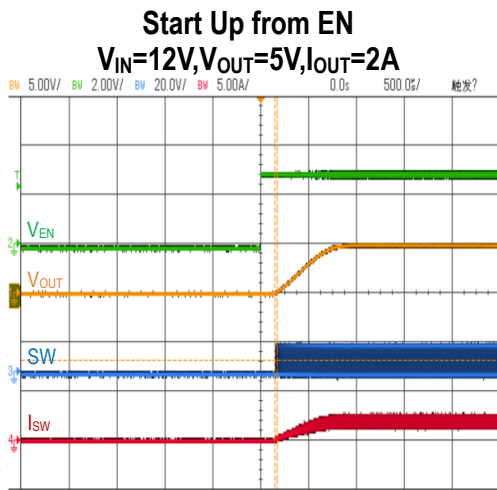

FUNCTIONAL BLOCK DIAGRAM

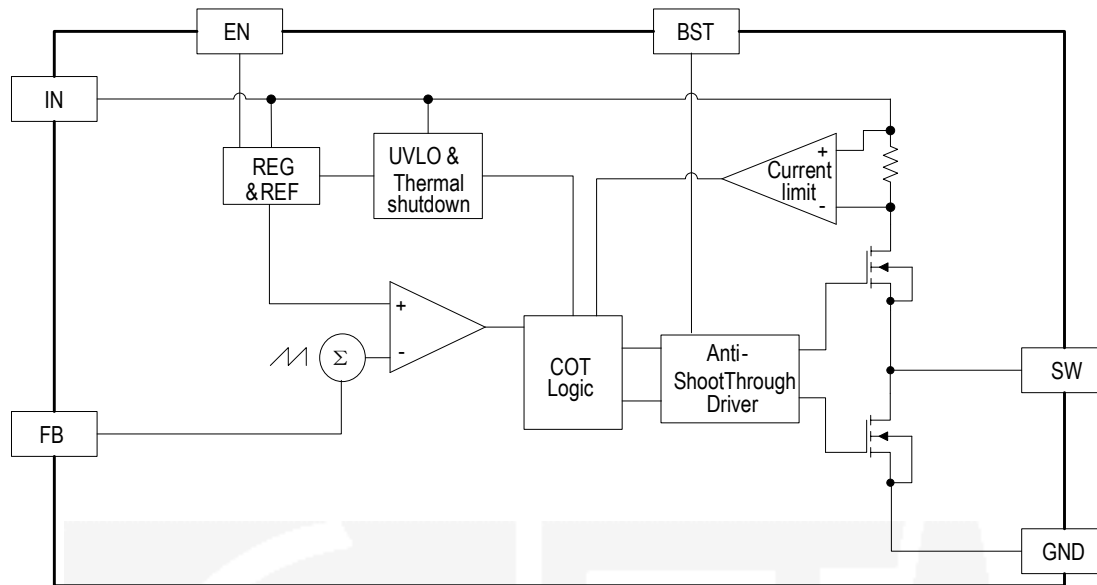

FUNCTIONAL DESCRIPTION

The ETA8110 is a synchronous buck regulator ICs that integrates the adaptive COT control, top and bottom switches on the same die to minimize the switching transition loss and conduction loss.

ETA8110 is a wide input range, high-efficiency and high frequency DC-to-DC step-down switching regulator, capable of delivering up to 2A of output current. It adopts an Adaptive COT control scheme that enables very fast transient response and provides a very smooth transition when the output varies from light load to heavy load. It compares the sum of the FB voltage and a ripple voltage that mimics the voltage due to the output ESR and capacitance. The constant-on-time timer varies with line to achieve relative constant switching frequency across line.

Forced PWM Mode

A forced PWM DC-DC regulator always switches at a fixed frequency when the output heavy load or light load. This is to ensure a minimum output voltage ripple over the full load range.

Enable

EN is a digital control pin that turns the ETA8110 on and off. Drive EN High to turn on the regulator, drive it Low to turn it off. An internal 1MΩ resistor from EN pin to GND allows EN to float to shut down the chip. Connecting the EN pin through a pull up resistor or shorted EN to IN will automatically turn on the chip whenever plug in IN.

Over Current Protection and Hiccup

ETA8110 has a cycle-by-cycle over current limit for when the inductor current peak value is over the set current limit threshold. When the output voltage drop until FB falls below UV threshold (0.2V), the ETA8110

will enter hiccup mode. It will turn off the chip immediately for 6mS. After that, it will try to re-starts as normal for 2mS. After 2mS, if FB is still below UV threshold, then the chip enters hiccup mode again. If FB is higher than UV threshold, it will enter the normal mode.

Over-Temperature Protection

Thermal protection disables the output when the junction temperature rises to approximately 150°C, allowing the device to cool down. When the junction temperature cools to approximately 135°C, the output circuitry is again enabled. Depending on power dissipation, thermal resistance, and ambient temperature, the thermal protection circuit may cycle on and off. This cycling limits regulator dissipation, protecting the device from damage as a result of overheating.

APPLICATION INFORMATION

External Output Voltage Setting

In external Output Voltage Setting Version selected, the ETA8110 regulator is programmed using an external resistor divider. The output voltage is calculated using below equation.

$$V_{OUT} = V_{REF} \times \left(1 + \frac{R_1}{R_2}\right)$$

Where: VREF =0.6V typically (the internal reference voltage)

Resistors R2 has to be between 1KOhm to 70KOhm and thus R1 is calculated by following equation.

$$R_1 = \left(\frac{V_{OUT}}{V_{REF}} - 1\right) \times R_2$$

PCB LAYOUT GUIDE

PCB layout is very important to achieve stable operation. It is highly recommended to duplicate EVB layout for optimum performance.

If change is necessary, please follow these guidelines and take Figure for reference.

- 1) Keep the path of switching current short and minimize the loop area formed by input cap, high-side MOSFET and low-side MOSFET.
- 2) Bypass ceramic capacitors are suggested to be put close to the Vin pin.
- 3) Ensure all feedback connections are short and direct. Place the feedback resistors and compensation components as close to the chip as possible.
- 4) Rout SW away from sensitive analog areas such as FB.
- 5) Connect IN, SW, and especially GND respectively to a large copper area to cool the chip to improve thermal performance and long-term reliability.

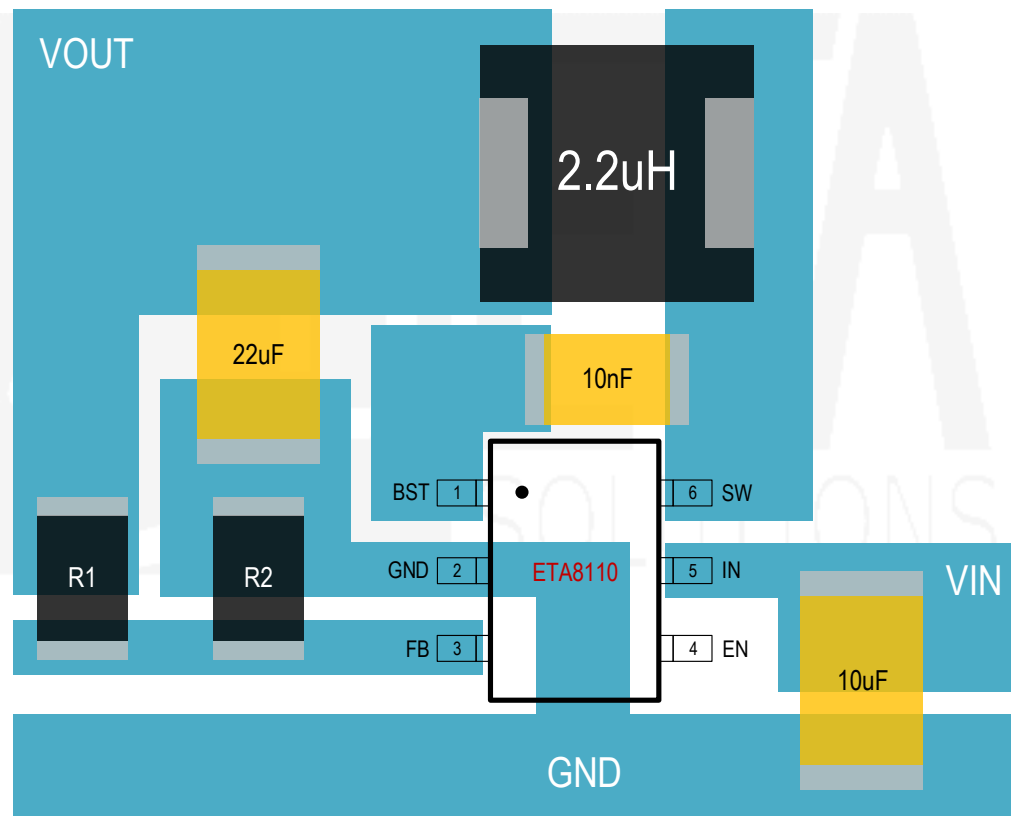

PACKAGE OUTLINE

Package: SOT23-6

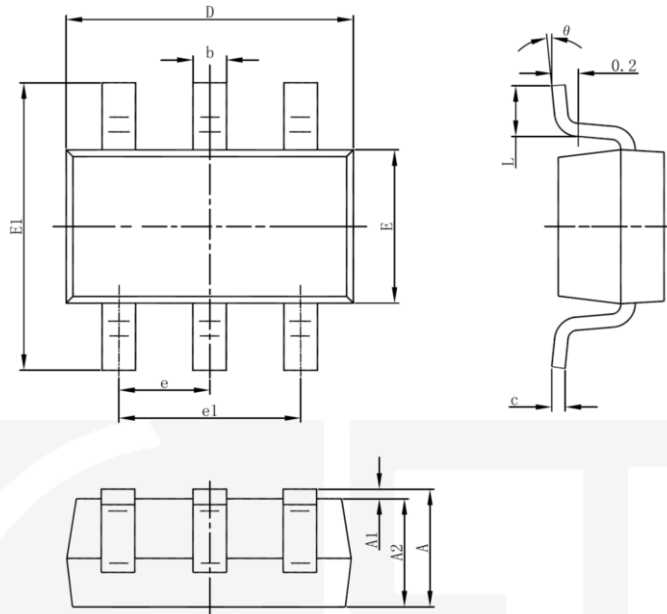

| Symbol | Dimensions In Millimeters | | Dimensions In Inches | |
|--------|---------------------------|-------|----------------------|-------|
| | Min | Max | Min | Max |
| A | 1.050 | 1.250 | 0.041 | 0.049 |
| A1 | 0.000 | 0.100 | 0.000 | 0.004 |
| A2 | 1.050 | 1.150 | 0.041 | 0.045 |
| b | 0.300 | 0.500 | 0.012 | 0.020 |
| c | 0.100 | 0.200 | 0.004 | 0.008 |
| D | 2.820 | 3.020 | 0.111 | 0.119 |
| E | 1.500 | 1.700 | 0.059 | 0.067 |
| E1 | 2.650 | 2.950 | 0.104 | 0.116 |
| e | 0.950(BSC) | | 0.037(BSC) | |
| e1 | 1.800 | 2.000 | 0.071 | 0.079 |
| L | 0.300 | 0.600 | 0.012 | 0.024 |
| θ | 0° | 8° | 0° | 8° |

TAPE AND REEL INFORMATION

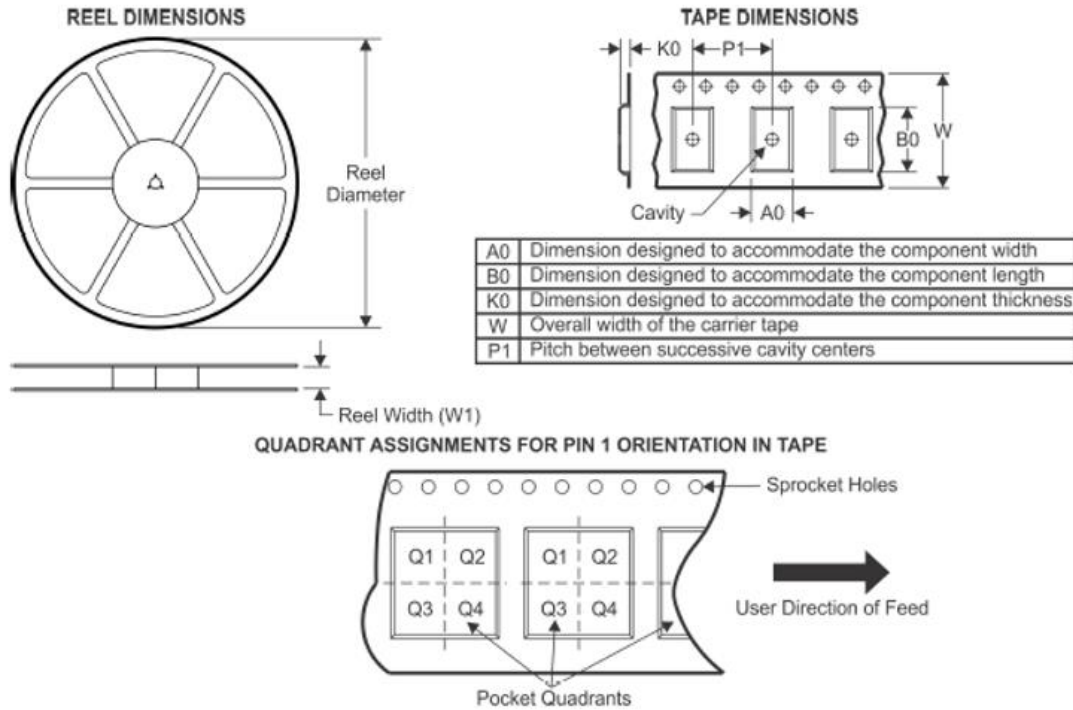

| Device | Package Type | Pins | SPQ | Reel Diameter (mm) | Reel Width W1 (mm) | A0 (mm) | B0 (mm) | K0 (mm) | P1 (mm) | W (mm) | Pin1 Quadrant |
|------------|--------------|------|------|--------------------|--------------------|---------|---------|---------|---------|--------|---------------|
| ETA8110S2G | SOT23-6 | 6 | 3000 | 180 | 9.5 | 3.17 | 3.23 | 1.37 | 4 | 8 | Q3 |