



◆特征:

- 环氧树脂涂层,耐湿度,使用寿命长.
- 电感范围宽,设计紧凑体积小,重量轻.
- 高Q和自我共振频率
- 编带包装可用于自动插件
- 符合 RoHS,无卤和 REACH

◆用途:

- 电视、个人电脑
- 收音机、电话
- 充电器,快充
- 其他各种电子产品

◆环境:

- 工作温度: -25℃ 至+85℃
(包括线圈自身温升)

◆试验设备:

- 电感值:HP4284A, HP4285A 或同等仪器
- 电流:HP4284+42841A
- 自谐振频率: HM 9461
- 品质因子: HP4285A
- 直流电阻: Chroma 16502 或同等仪器

◆产品型号:

Features:

- Coating epoxy resin that ensure the humidity resistance to be long life
- Design to be compact, small and light-weight
Wide range of inductance
- Contribute to be high Q and self-resonant frequencies
- Tape packaging for auto-insertion
- RoHS, Halogen Free and REACH Compliance

Applications:

- Televisions, personal computers
- Radios, telephones
- Charger, fast charge
- Other various electronic products

Environmental Data:

- Operating Temperature: -25℃ to +85℃
(Including coils self-temperature rise)

Test Equipment:

- L:HP4284A or HP4285A LCR meter or equivalent
- Isat & Irms: HP4284+42841A
- SRF: HM 9461
- Q: HP4285A
- DCR:Chroma 16502 or equivalent

Product Identification:

EC ①	0510 ②	100 ③	K ④	I ⑤										
①	②	③	④	⑤										
<table border="1"> <tr> <td colspan="2" style="text-align: center;">类型 Type</td> </tr> <tr> <td style="text-align: center;">EC</td> <td style="text-align: center;">轴向固定电感 Axial Fixed Inductors</td> </tr> </table>		类型 Type		EC	轴向固定电感 Axial Fixed Inductors	<table border="1"> <tr> <td colspan="2" style="text-align: center;">外形尺寸(L×W×H) (mm) External Dimensions (L×H) (mm)</td> </tr> <tr> <td style="text-align: center;">0510</td> <td style="text-align: center;">5.0×11</td> </tr> </table>		外形尺寸(L×W×H) (mm) External Dimensions (L×H) (mm)		0510	5.0×11	<table border="1"> <tr> <td style="text-align: center;">Inductance</td> </tr> <tr> <td style="text-align: center;">10 uH</td> </tr> </table>	Inductance	10 uH
类型 Type														
EC	轴向固定电感 Axial Fixed Inductors													
外形尺寸(L×W×H) (mm) External Dimensions (L×H) (mm)														
0510	5.0×11													
Inductance														
10 uH														
<table border="1"> <tr> <td colspan="2" style="text-align: center;">公差 Inductance Tolerance</td> </tr> <tr> <td colspan="2" style="text-align: center;">J:±5%,K: ±10%, L: ±15% M: ±20%,P: ±25%, N: ±30%</td> </tr> </table>		公差 Inductance Tolerance		J:±5%,K: ±10%, L: ±15% M: ±20%,P: ±25%, N: ±30%		<table border="1"> <tr> <td colspan="2" style="text-align: center;">包装 Packing</td> </tr> <tr> <td style="text-align: center;">B</td> <td style="text-align: center;">散装 Bulk Package</td> </tr> <tr> <td style="text-align: center;">T</td> <td style="text-align: center;">编带 Tape</td> </tr> </table>		包装 Packing		B	散装 Bulk Package	T	编带 Tape	
公差 Inductance Tolerance														
J:±5%,K: ±10%, L: ±15% M: ±20%,P: ±25%, N: ±30%														
包装 Packing														
B	散装 Bulk Package													
T	编带 Tape													

◆颜色编码:

Color Coding:

The nominal inductance is marked. Color code listed in table below. 标称电感值用色码编码表示如下表所示。

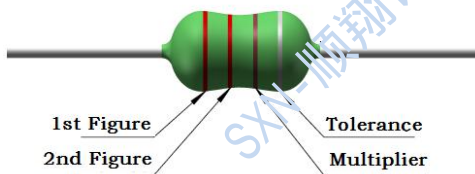
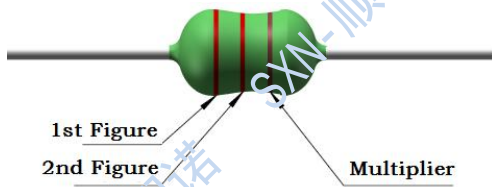

Color 颜色	Nominal Inductance(uH)标称电感值(微亨)			
	1st Figure	2nd Figure	Multiplier	Tolerance
Black 黑		0	x1	±20%
Brown 棕		1	x10	
Red 红		2	x100	
Orange 橙		3	x1000	
Yellow 黄		4		
Green 绿		5		
Blue 蓝		6		
Violet 紫		7		
Gray 灰		8		
White 白		9		
Gold 金			x0.1	±5%
Silver 银			x0.01	±10%

◆外观尺寸:

Shape and Dimensions(dimensions are in mm):

F1

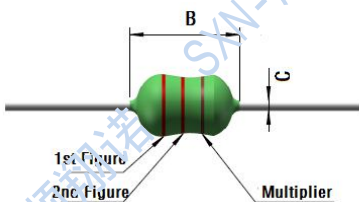

F2

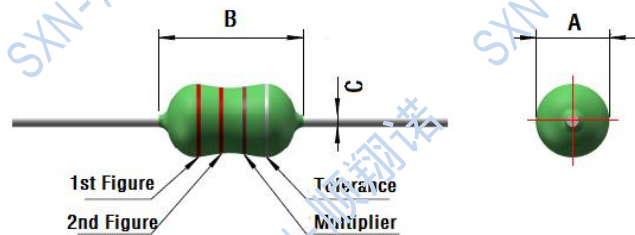

Part No	ITEM			
	Figure	A	B	C
EC0510	F2	Ø5.0 Max	11.0 Max	Ø0.60 ± 0.1

◆规格特性:

Specifications:

● EC0510 Series Electrical Characteristics (Electrical specifications at 25°C)

Part No	Inductance		Q	Q	SRF	DCR	Rated Current
	@ 1KHz L(μH)	Tole	Min	Test Freq	(MHz) Min	(Ω) Max	(mA) Max
EC0510-3R3M	3.3	±20%	10	7.96MHZ	50	0.18	1100
EC0510-4R7M	4.7	±20%	20	7.96MHZ	45	0.20	1000
EC0510-6R8M	6.8	±20%	15	7.96MHZ	45	0.25	790
EC0510-100K	10	±10%	15	7.96MHZ	30	0.45	750
EC0510-150K	15	±10%	30	7.96MHZ	30	0.50	650
EC0510-220K	22	±10%	30	2.52 MHz	8.0	0.65	500
EC0510-330K	33	±10%	30	2.52 MHz	6.0	0.75	400
EC0510-470K	47	±10%	30	2.52 MHz	6.3	0.8	370
EC0510-680K	68	±10%	25	2.52 MHz	5.0	0.8	350
EC0510-820K	82	±10%	20	2.52 MHz	3.8	0.82	330
EC0510-101K	100	±10%	20	2.52 MHz	3.5	0.90	300
EC0510-121K	120	±10%	20	0.796 MHz	3.3	1.20	250
EC0510-151K	150	±10%	20	0.796 MHz	3.2	1.80	225
EC0510-181K	180	±10%	20	0.796 MHz	2.8	2.00	200
EC0510-221K	220	±10%	30	0.796 MHz	2.6	2.30	180
EC0510-271K	270	±10%	30	0.796 MHz	2.4	2.50	170
EC0510-331K	330	±10%	30	0.796 MHz	2.2	3.00	160
EC0510-391K	390	±10%	30	0.796 MHz	2.0	3.50	150
EC0510-471K	470	±10%	30	0.796 MHz	1.9	4.00	140
EC0510-561K	560	±10%	30	0.796 MHz	1.8	5.40	130
EC0510-681K	680	±10%	40	0.796 MHz	1.5	6.00	120
EC0510-821K	820	±10%	50	0.796 MHz	1.2	7.50	110
EC0510-102K	1000	±10%	50	0.252 MHz	1.0	8.00	100
EC0510-122K	1200	±10%	60	0.252 MHz	0.95	14.50	95
EC0510-152K	1500	±10%	60	0.252 MHz	0.9	16.50	90
EC0510-182K	1800	±10%	60	0.252 MHz	0.9	19.00	85
EC0510-222K	2200	±10%	60	0.252 MHz	0.8	27.50	80
EC0510-272K	2700	±10%	60	0.252 MHz	0.75	40.00	75
EC0510-332K	3300	±10%	50	0.252 MHz	0.7	50.00	62
EC0510-392K	3900	±10%	50	0.252 MHz	0.65	53.00	59
EC0510-472K	4700	±10%	50	0.252 MHz	0.6	60.00	55
EC0510-562K	5600	±10%	50	0.252 MHz	0.5	64.00	40
EC0510-682K	6800	±10%	50	0.252 MHz	0.45	73.00	35
EC0510-822K	8200	±10%	30	0.252 MHz	0.4	80.00	30
EC0510-103K	10000	±10%	25	79.6 KHZ	0.35	132.00	25
EC0510-123K	12000	±10%	25	79.6 KHZ	0.3	143.00	20
EC0510-153K	15000	±10%	25	79.6 KHZ	0.25	166.00	18
EC0510-183K	18000	±10%	25	79.6 KHZ	0.2	185.00	15
EC0510-223K	22000	±10%	20	79.6 KHZ	0.15	330.00	12
EC0510-273K	27000	±10%	20	79.6 KHZ	0.1	370.00	10
EC0510-333K	33000	±10%	40	79.6 KHZ	0.25	240.00	10

- Saturation Current: DC current at which inductance drops 10% from its value without current.
- Temperature Rise Current: the actual value of DC current when the temperature rise is $\Delta T 40^{\circ}C$ ($T_a=25^{\circ}C$).
- Rated DC Current: The less value which is Isat or Irms.

◆产品包装:

Packaging:

● Tape Specifications (mm) 编带尺寸

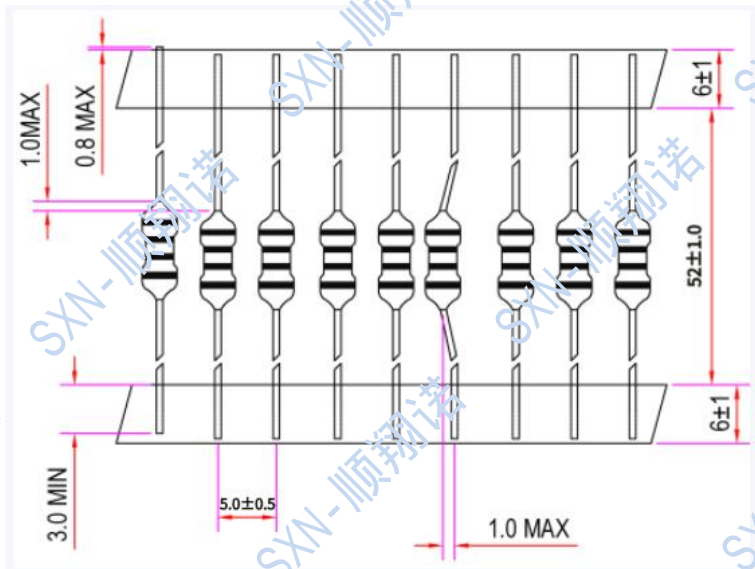

● Tape Specifications for T5A (mm) 直脚编带盒装, 产品常规包装方式

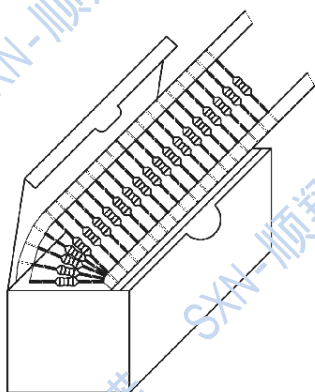

INSIDE BOX

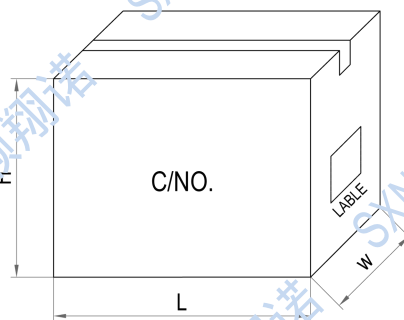

Outside Carton



不足整箱用内盒或填充物装满

● Tape and reel specification (mm)

Series	Type	Packaging Quantity(pcs)			Carton Size(mm)		
		Parts/Box	Parts/Reel	Parts/Carion	L	W	H
	T5A	1000		24,000	440	275	392

◆可靠性测试:

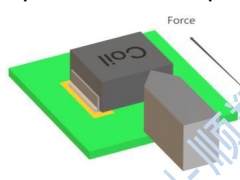
Reliability Testing:

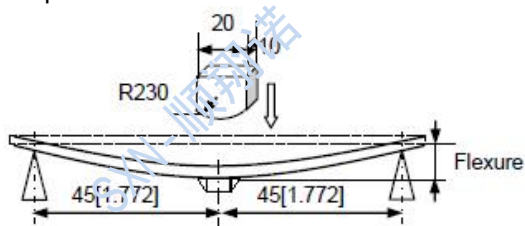
Items	Requirements	Test Methods and Remarks
Terminal Strength Reference documents: GB/T 2423.60-2008 端子強度(SMT)	1. Pulling test: Define: A: sectional area of terminal $A \leq 8\text{mm}^2$ force $\geq 5\text{N}$ time: 30sec $8\text{mm}^2 < A \leq 20\text{mm}^2$ force $\geq 10\text{N}$ time: 10sec $20\text{mm}^2 < A$ force $\geq 20\text{N}$ time: 10sec 2. Solder paste thickness: 0.12mm 3. Meet the above requirements without any loose terminal	Solder the inductor to the testing jig using leadfree solder. Then apply a force in the Keep time: $10 \pm 1\text{s}$ Speed: 1.0mm/s 
Terminal Strength Reference documents: GB/T 2423.60-2008 端子強度(DIP)	1. Terminal diameter (d) mm $0.35 < d \leq 0.50$ Applied force: 5N Duration: 10sec 2. Terminal diameter (d) mm $0.50 < d \leq 0.80$ Applied force: 10N Duration: 10sec 3. Terminal diameter (d) mm $0.80 < d \leq 1.25$ Applied force: 20N Duration: 10sec 4. Terminal diameter (d) mm $D > 1.25$ Applied force: 40N Duration: 10sec 5. Meet the above requirements without any loose terminal.	Pull Force: the force shall be applied gradually to the terminal and then maintained for 10 seconds. 
Resistance to Flexure JIS C 5321:1997 抗弯曲性试验	1. No visible mechanical damage.	1. Solder the inductor to the test jig (glass epoxy board) 2. shown in Using a leadfree solder. Then apply a force in the direction shown 3. Flexure: 2mm. 4. Pressurizing Speed: 0.5mm/sec. 5. Keep time: 30 sec. 
Dropping Reference documents: GB/T 2423.7-2018 落下試驗	1. No case deformation or change in appearance. 2. No short and no open.	1. Drop the packaged products from 1m high in 1 angle, 3 ridges and 6 surfaces, twice in each direction.
Solderability Reference documents: GB/T 2423.28-2005 可焊性试验	1. No visible mechanical damage. 2. Wetting shall exceed 75% coverage for 3. Terminals must have 95% minimum solder coverage	1. Solder temperature: $240 \pm 2^\circ\text{C}$ 2. Duration: 3 sec 3. Solder: Sn/3.0Ag/0.5Cu. 4. Flux: 25% Resin and 75% ethanol in weight

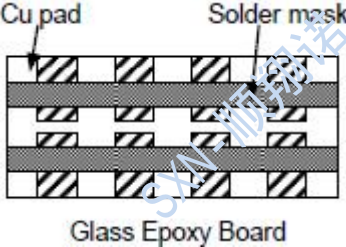
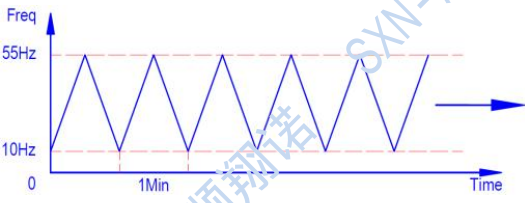
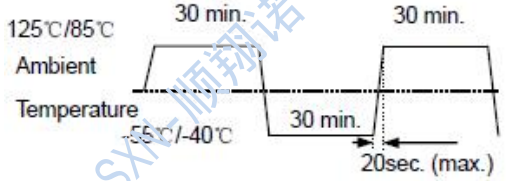
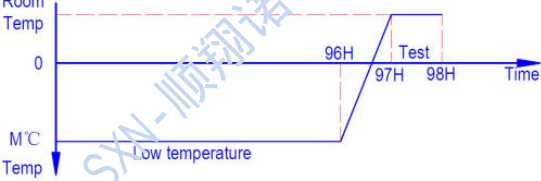
Items	Requirements	Test Methods and Remarks
<p>Vibration</p> <p>Reference documents: GB/T 2423.10-2019</p> <p>振動試驗</p>	<p>1.No visible mechanical damage.</p> <p>2. Inductance change: Within $\pm 10\%$.</p> <p>3. Q factor change: Within $\pm 20\%$.</p> 	<p>1. Solder the inductor to the testing jig (glass epoxy board shown in) using leadfree solder.</p> <p>2.The inductor shall be subjected to a simple harmonic motion having total amplitude of 1.5mm, the frequency being varied uniformly between the approximate limits of 10 and 55 Hz.</p> <p>3.The frequency range from 10 to 55 Hz and return to 10 Hz shall be traversed in approximately 1 minute. This motion shall be applied for a period of 2 hours in each 3 mutually perpendicular directions (total of 6 hours).</p> 
<p>Thermal Shock</p> <p>Reference documents: GB/T 2423.22-2012</p> <p>Method Na</p> <p>冷热冲击试验</p>	<p>1.No visible mechanical damage.</p> <p>2. Inductance change: Within $\pm 10\%$. (Mn-Zn: Within $\cong 30\%$)</p> <p>3. Q factor change: Within $\pm 20\%$.</p>	<p>1. Start at (85~125℃) for T time, rush to (-55~40℃) for T time as one cycle, go through 100 cycles.</p> <p>2. Transforming interval: Max. 20 sec.</p> <p>3. Tested cycle: 100 cycles.</p> <p>4. The chip shall be stabilized at normal condition for 1~2 hours</p> 
<p>Low temperature Storage</p> <p>Reference documents: GB/T 2423.1-2008</p> <p>Method Aa</p> <p>低温儲存試驗</p>	<p>1.No visible mechanical damage.</p> <p>2. Inductance change: Within $\pm 10\%$. (Mn-Zn: Within $\cong 30\%$)</p> <p>3. Q factor change: Within $\pm 20\%$.</p>	<p>1. Temperature: M(-55~40± 2℃)</p> <p>2. Duration: 96± 2 hours</p> <p>3. The chip shall be stabilized at normal condition for 1~2 hours before measuring.</p> 

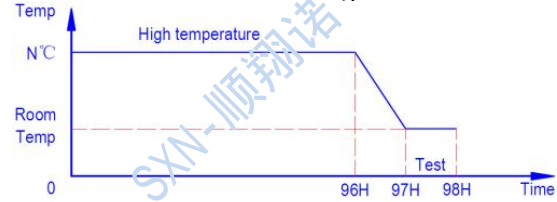
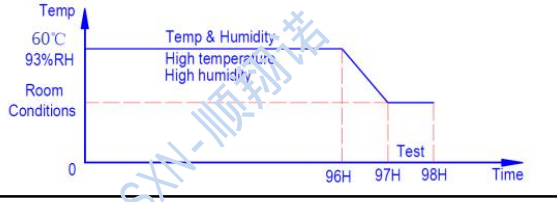
Items	Requirements	Test Methods and Remarks
High temperature Storage Reference documents: GB/T 2423.2-2003 Method Bb 高温储存试验	1.No visible mechanical damage. 2. Inductance change: Within $\pm 10\%$.(Mn-Zn: Within $\leq 30\%$) 3.Q factor change: Within $\pm 20\%$.	1.Temperature:N(125~85 $\pm 2^{\circ}\text{C}$). 2.Duration: 96 ± 2 hours 3.The chip shall be stabilized at normal condition for 1~2 hours before measuring. 
Damp Heat (Steady States) Reference documents: GB/T 2423.3-2016 恒定湿热试验	1.No visible mechanical damage. 2. Inductance change: Within $\pm 10\%$.(Mn-Zn: Within $\leq 30\%$) 3.Q factor change: Within $\pm 20\%$.	1.Temperature: 60 $\pm 2^{\circ}\text{C}$ 2.Humidity: 90% to 95% RH. 3.Duration: 96 ± 2 hours. 4.The chip shall be stabilized at normal condition for 1~2 hours before measuring. 
Heat endurance of Reflow soldering Reference documents: GJB 360B-2009 回流焊耐热性试验	1.No significant defects in appearance. 2. $\Delta L/L \leq 10\%$ (Mn-Zn: $\Delta L/L \leq 30\%$) 3. $\Delta Q/Q \leq 30\%$ (SMD series only) 4. $\Delta DCR/DCR \leq 10\%$	1.Refer to the above reflow curve and go through the reflow for twice. 2.The peak temperature : 260+0/-5 $^{\circ}\text{C}$
Resistance to solvent test Reference documents: IEC 68-2-45:1993 耐溶剂性试验	No case deformation or change in appearance or obliteration of marking	To dip parts into IPA solvent for 5 ± 0.5 Min,then drying them at room temp for 5Min,at last ,to brushing making 10 times.
Overload test Reference documents: JIS C5311-6.13 过负荷试验	1.During the test no smoke, no peculiar, smell, no fire 2.The characteristic is normal after test	Apply twice as rated current for 5 minutes.
voltage resistance test Reference documents: MIL-STD-202G Method 301 绝缘耐压测试	1.During the test no breakdown 2.The characteristic is normal after test	1. For parts with two coils 2. DC1000V, Current: 1mA, Time: 1Min. 3. Refer to catalogue of specific products

◆推荐无铅波峰焊接曲线:

Lead-free the recommended wave soldering (DIP-TYP) :

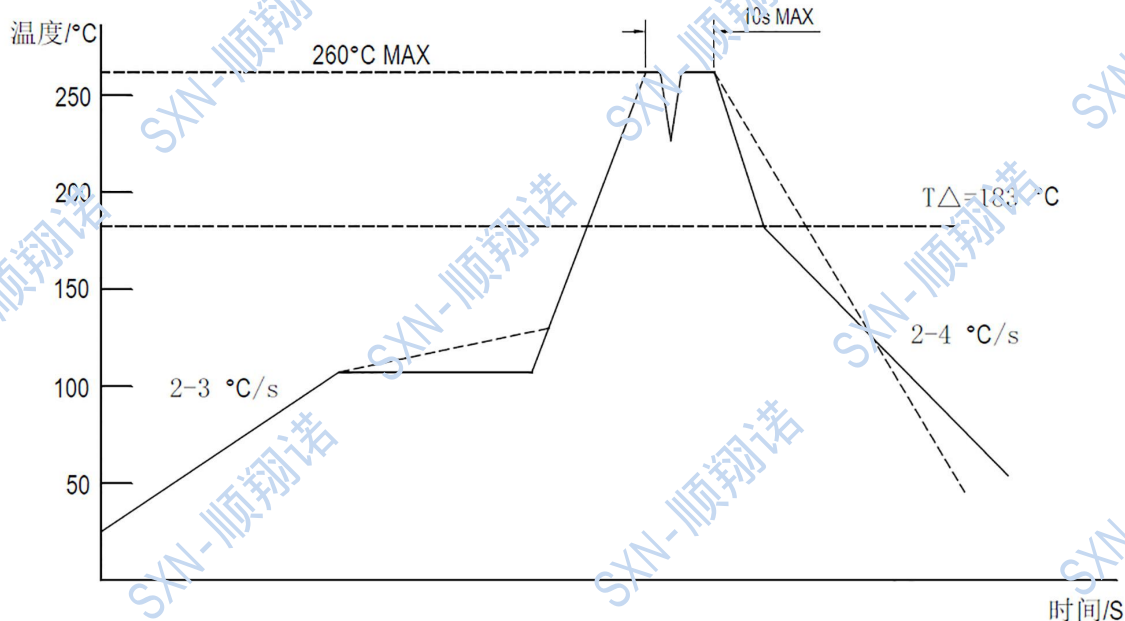

Notes:

The recommended wave soldering, is a reference to a single wave soldering recommended by the manufacturer, because the various manufacturers of soldering equipment, product process conditions, set methods and so on, when setting the soldering conditions, Please adjust and confirm according to users' environment/equipments.

● **Appendix 2: Soldering Iron (Rework)**

- 1) Use soldering iron to solder inductors by hand, times does Not exceed 350 degrees 3 times.
- 2) When soldering iron welding, please try to avoid contacting the Inductor itself. (definitely do not contact the wire)
- 3) To solder inductors by soldering iron is not recommend(!)

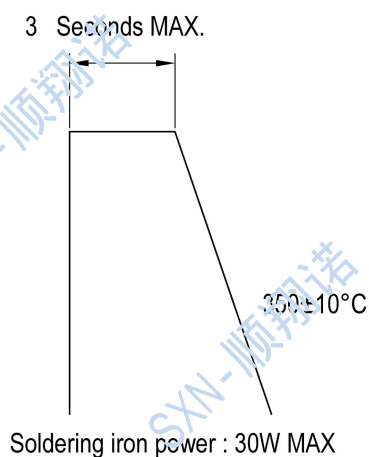

使用注意事项

REMINDERS FOR USING THESE PRODUCTS



- 保存时间为12 个月以内，保存条件（温度5~40°C以下、湿度35 ~ 66%RH 以下），需充分注意。若超过保存时间，端子电极的可焊性将可能老化。

The storage period is within 12 months. Be sure to follow the storage conditions (temperature: 5~40°C, humidity: 35 to 65% RH or less). If the storage period elapses, the soldering of the terminal electrodes may deteriorate.

- 请勿在气体腐蚀环境（盐、酸、碱等）下使用和保存。

Do not use or store in locations where there are conditions such as gas corrosion (salt, acid, alkali, etc.).

- 手上的油脂会导致可焊性降低，应避免用手直接接触端子。

Don't touch electrodes directly with bare hands as oil secretions may inhibit soldering. Always ensure optimum conditions for soldering.

- 请小心轻拿轻放，避免由于产品的跌落或取出不当而导致的损坏。

Please always handle products carefully to prevent any damage caused by dropping down or inappropriate removing.

- 端子过度弯曲会导致断线，请不要过度弯曲端子。

Don't bend the terminals with excessive stress in case of any wire fracture.

- 不要清洗产品，如需要清洗时请联系我司。

Don't rinse coils by yourself and please contact SXN if necessary.

- 请勿将本产品靠近磁铁或带有磁力的物体

Don't expose the products to magnets or magnetic fields

- 在实施焊接前，请务必进行预热。预热温度与焊接温度及芯片温度的温度差要在150°C 以内。

Before soldering, be sure to preheat components. The preheating temperature should be set so that the temperature difference between the solder temperature and chip temperature does not exceed 150°C.

- 安装后的焊接修正应在规格书规定的条件范围内。若加热过度可能导致短路、性能降低、寿命减少。

Soldering corrections after mounting should be within the range of the conditions determined in the specifications. If overheated, a short circuit, performance deterioration, or lifespan shortening may occur.

- 装置会因通电而自我发热（温度上升），因此在热设计方面需留有充分余地。

Self heating (temperature increase) occurs when the power is turned ON, so the tolerance should be sufficient for the set thermal design.

- 非磁屏蔽型在基板设计时需注意配置线圈，受到电磁干扰可能会导致误动作。

Carefully lay out the coil for the circuit board design of the non-magnetic shield type. A malfunction may occur due to magnetic interference.