

**Product features and main applications:**

NPNP five-layer structure of silicon bidirectional devices; with independent intellectual property rights of single-sided digging technology, table glass passivation process; multi-layer metallized electrodes on the back; with high blocking voltage and high temperature stability.

**Mainly used in:**

vacuum cleaners, power tools and other motor speed controllers; solid state relays; heating controllers (temperature regulation); other phase control circuits.

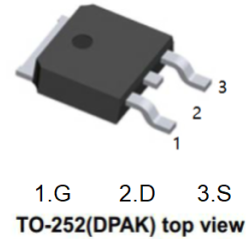

**Characteristics**

Absolute maximum ratings (Tj = 25 °C unless otherwise stated)

Symbol	Parameter name		value	Unit
$I_{T(RMS)}$	RMS on-state current (full sine wave)	BTA BTB	Tc=80°C Tc=90°C	12 A
$I_{TSM}$	Non repetitive surge peak on-state current (full cycle, Tj initial = 25°C)	F=50HZ tp=20ms	120	A
$I^2t$	I <sup>2</sup> t value for fusing	tp=10ms	72	A <sup>2</sup> S
di/dt	Critical rate of rise of on -state current IG = 2 x IGT, tr ≤ 100 ns	Tj=125°C	50	A/us

$V_{DRM} / V_{RRM}$	Off state repetitive peak voltage Reverse repetitive peak voltage	$T_j=25^{\circ}\text{C}$		600/800/1000	V
$I_{GM}$	Peak gate current	$t_p=20\mu\text{s}$	$T_j=150^{\circ}\text{C}$	4	A
$P_{G(AV)}$	Average gate power dissipation		$T_j=150^{\circ}\text{C}$	1	W
$T_{stg}$ $T_j$	Storage junction temperature range Operating junction temperature range			-40to+150 -40to+125	$^{\circ}\text{C}$

**Electrical characteristics ( $T_j = 25^{\circ}\text{C}$ , unless otherwise specified) --3 quadrants**

Symbol	Name and test conditions	Quadrant	Range	value	Unit
$I_{GT}$	$V_D=12\text{V}$ $R_L=100\Omega$	I II III	MAX	$\leq 50$	mA
$V_{GT}$			MAX	1.5	V
$V_{GD}$			MIN	0.2	V
$I_H$	$I_T = 100\text{ mA}$		MAX	60	mA
$I_L$	$I_G = 1.2 \times I_{GT}$		MAX	60	mA
				100	
dv/dt	$V_D = 67\% V_{DRM}$ , gate open, $T_j = 125^{\circ}\text{C}$		MIN	500	V/us
(dv/dt)c	Critical rise rate of commutation voltage $T_J = 150^{\circ}\text{C}$		MIN	8	V/us

**Electrical characteristics (T<sub>j</sub> = 25 °C, unless otherwise specified)**  
**-Standard Triac (4 quadrants)**

Symbol	Name and test conditions	Quadrant	Range	value	Unit	
I <sub>GT</sub>	V <sub>D</sub> =12V R <sub>L</sub> =100Ω	I II III IV	MAX	I II III	mA	
				IV		
V <sub>GT</sub>	V <sub>D</sub> = V <sub>DRM</sub> , R <sub>L</sub> = 3.3 kΩ , T <sub>j</sub> = 125°C		MAX	1.5		V
				MIN	0.2	
I <sub>H</sub>	I <sub>T</sub> =500mA	MAX	60		mA	
I <sub>L</sub>	I <sub>G</sub> = 1.2 x I <sub>GT</sub>	MAX	60		mA	
			100			
dv/dt	V <sub>D</sub> = 67% V <sub>DRM</sub> , gate open, T <sub>j</sub> = 125°C	MIN	500		V/us	
(dv/dt) <sub>c</sub>	Critical rise rate of commutation voltage T <sub>J</sub> = 150°C	MIN	10		V/us	

**Static parameters**

Symbol	Parameter name			value	Unit
$V_{TM}$	$I_{TM} = 24A$	$T_j = 25^{\circ}C$	MAX	1.50	V
$V_{TO}$	threshold on-state voltage	$T_j = 150^{\circ}C$	MAX	0.86	V
$R_d$	Dynamic resistance	$T_j = 150^{\circ}C$	MAX	36.6	mΩ
$I_{DRM}$ $I_{RRM}$	VDRM = VRRM	$T_j = 25^{\circ}C$ $T_j = 150^{\circ}C$	MAX	5	uA
				1	mA
$R_{th(j-c)}$	Junction to ambient	BTA		2.05	/W
		BTB		1.25	

**BT138-800 characteristic curve**

**FIG.1** Maximum power dissipation versus RMS on-state current

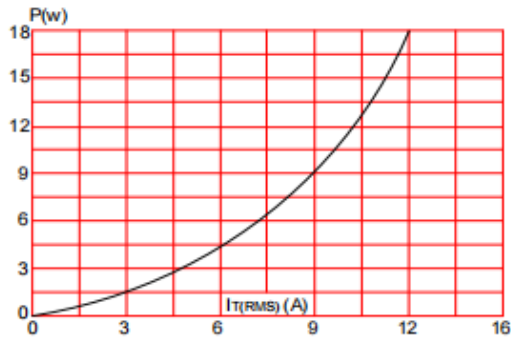

**FIG.3:** Surge peak on-state current versus number of cycles

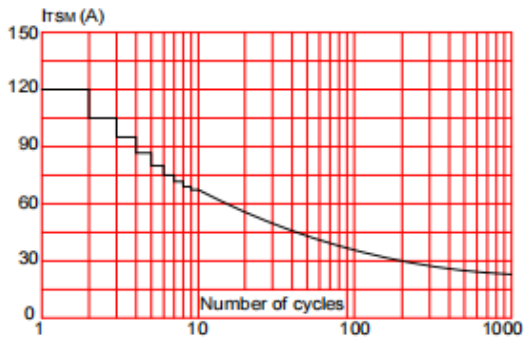

**FIG.5:** Non-repetitive surge peak on-state current for a sinusoidal pulse with width  $t_p < 10\text{ms}$ , and corresponding value of  $I^2t$  ( $dI/dt < 50\text{A}/\mu\text{s}$ )

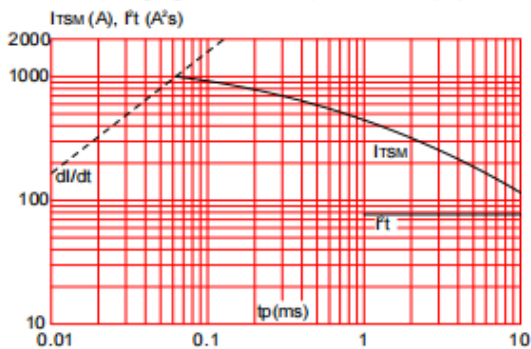

**FIG.2:** RMS on-state current versus case temperature

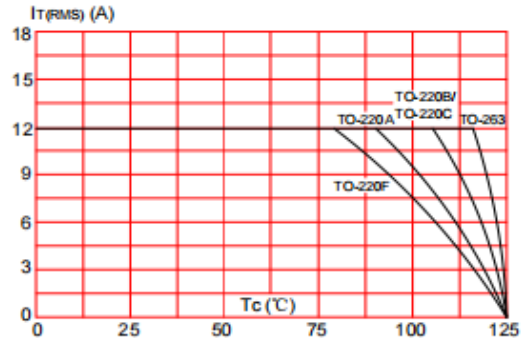

**FIG.4:** On-state characteristics (maximum values)

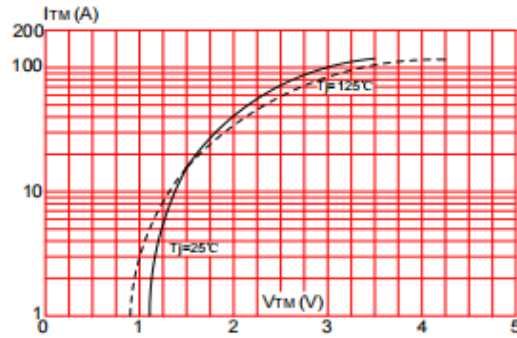

**FIG.6:** Relative variations of gate trigger current, holding current and latching current versus junction temperature

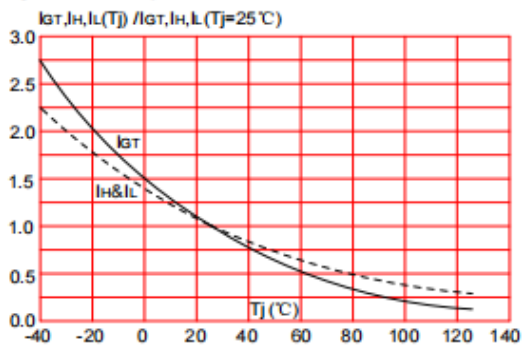

Package Mechanical Data TO-252

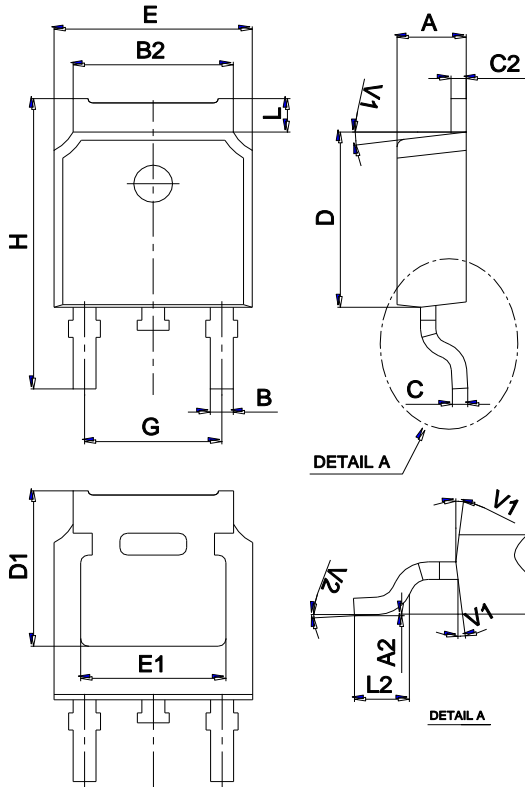

Ref.	Dimensions					
	Millimeters			Inches		
	Min.	Typ.	Max.	Min.	Typ.	Max.
A	2.10		2.50	0.083		0.098
A2	0		0.10	0		0.004
B	0.66		0.86	0.026		0.034
B2	5.18		5.48	0.202		0.216
C	0.40		0.60	0.016		0.024
C2	0.44		0.58	0.017		0.023
D	5.90		6.30	0.232		0.248
D1	5.30REF			0.209REF		
E	6.40		6.80	0.252		0.268
E1	4.63			0.182		
G	4.47		4.67	0.176		0.184
H	9.50		10.70	0.374		0.421
L	1.09		1.21	0.043		0.048
L2	1.35		1.65	0.053		0.065
V1		7°			7°	
V2	0°		6°	0°		6°

Marking

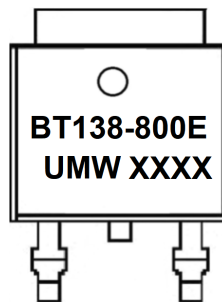

Ordering information

Order code	Package	Baseqty	Deliverymode
UMW BT138D-800E	TO-252	2500	Tape and reel