

### Description

The HSH4119 is the high cell density trench P-ch MOSFETs, which provide excellent RDSON and gate charge for most of the synchronous buck converter applications.

The HSH4119 meet the RoHS and Green Product requirement, 100% EAS guaranteed with full function reliability approved.

- Super Low Gate Charge
- 100% EAS Guaranteed
- Green Device Available
- Excellent CdV/dt effect decline
- Advanced high cell density Trench technology

### Product Summary

V <sub>DS</sub>	-40	V
R <sub>DS(ON),typ</sub>	3.9	mΩ
I <sub>D</sub>	-150	A

### TO-263 Pin Configuration

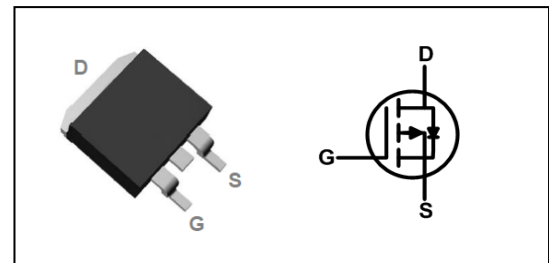

### Absolute Maximum Ratings

Symbol	Parameter	Rating	Units
V <sub>DS</sub>	Drain-Source Voltage	-40	V
V <sub>GS</sub>	Gate-Source Voltage	±20	V
I <sub>D</sub> @T <sub>C</sub> =25°C	Continuous Drain Current, V <sub>GS</sub> @ -10V <sup>1,6</sup>	-150	A
I <sub>D</sub> @T <sub>C</sub> =100°C	Continuous Drain Current, V <sub>GS</sub> @ -10V <sup>1,6</sup>	-103	A
I <sub>DM</sub>	Pulsed Drain Current <sup>2</sup>	-580	A
EAS	Single Pulse Avalanche Energy <sup>3</sup>	1250	mJ
I <sub>AS</sub>	Avalanche Current	-70	A
P <sub>D</sub> @T <sub>C</sub> =25°C	Total Power Dissipation <sup>4</sup>	200	W
T <sub>STG</sub>	Storage Temperature Range	-55 to 150	°C
T <sub>J</sub>	Operating Junction Temperature Range	-55 to 150	°C

### Thermal Data

Symbol	Parameter	Typ.	Max.	Unit
R <sub>θJA</sub>	Thermal Resistance Junction-ambient <sup>1</sup> (Steady State)	---	62	°C/W
R <sub>θJC</sub>	Thermal Resistance Junction-case <sup>1</sup>	---	0.95	°C/W

**Electrical Characteristics ( $T_J=25\text{ }^\circ\text{C}$ , unless otherwise noted)**

Symbol	Parameter	Conditions	Min.	Typ.	Max.	Unit
$BV_{DSS}$	Drain-Source Breakdown Voltage	$V_{GS}=0V, I_D=-250\mu A$	-40	---	---	V
$R_{DS(ON)}$	Static Drain-Source On-Resistance <sup>2</sup>	$V_{GS}=-10V, I_D=-30A$	---	3.9	4.5	$m\Omega$
		$V_{GS}=-4.5V, I_D=-20A$	---	4.9	5.6	$m\Omega$
$V_{GS(th)}$	Gate Threshold Voltage	$V_{GS}=V_{DS}, I_D=-250\mu A$	-1.0	---	-2.5	V
$I_{DSS}$	Drain-Source Leakage Current	$V_{DS}=-40V, V_{GS}=0V, T_J=25^\circ C$	---	---	-1	$\mu A$
		$V_{DS}=-40V, V_{GS}=0V, T_J=125^\circ C$	---	---	-100	$\mu A$
$I_{GSS}$	Gate-Source Leakage Current	$V_{GS}=\pm 20V, V_{DS}=0V$	---	---	$\pm 100$	nA
$R_g$	Gate resistance	$V_{DS}=0V, V_{GS}=0V, f=1MHz$		1.7		$\Omega$
$Q_g$	Total Gate Charge (-10V)	$V_{DS}=-20V, V_{GS}=-10V, I_D=-20A$	---	190	---	nC
$Q_{gs}$	Gate-Source Charge		---	24	---	
$Q_{gd}$	Gate-Drain Charge		---	38	---	
$T_{d(on)}$	Turn-On Delay Time	$V_{DD}=-20V, V_{GS}=-10V, R_G=3\Omega, I_D=-10A$	---	18	---	ns
$T_r$	Rise Time		---	3.6	---	
$T_{d(off)}$	Turn-Off Delay Time		---	21	---	
$T_f$	Fall Time		---	39	---	
$C_{iss}$	Input Capacitance	$V_{DS}=-20V, V_{GS}=0V, f=1MHz$	---	10700	---	pF
$C_{oss}$	Output Capacitance		---	780	---	
$C_{rss}$	Reverse Transfer Capacitance		---	660	---	

**Diode Characteristics**

Symbol	Parameter	Conditions	Min.	Typ.	Max.	Unit
$I_S$	Continuous Source Current <sup>1,5</sup>	$V_G=V_D=0V$ , Force Current	---	---	-150	A
$V_{SD}$	Diode Forward Voltage <sup>2</sup>	$V_{GS}=0V, I_S=-20A, T_J=25^\circ C$	---	---	-1.2	V
$t_{rr}$	Reverse Recovery Time	$I_F=-20A, di/dt=100A/\mu s,$	---	52	---	nS
$Q_{rr}$	Reverse Recovery Charge	$T_J=25^\circ C$	---	128	---	nC

Note :

- 1.The data tested by surface mounted on a 1 inch<sup>2</sup> FR-4 board with 2OZ copper.
- 2.The data tested by pulsed , pulse width  $\leq 300\mu s$  , duty cycle  $\leq 2\%$
- 3.The EAS data shows Max. rating . The test condition is  $V_{DD}=-40V, V_{GS}=-10V, L=0.5mH, I_{AS}=-70A$
- 4.The power dissipation is limited by 150 $^\circ C$  junction temperature
- 5.The data is theoretically the same as  $I_D$  and  $I_{DM}$  , in real applications , should be limited by total power dissipation
- 6.The maximum current rating is package limited.



Typical Characteristics

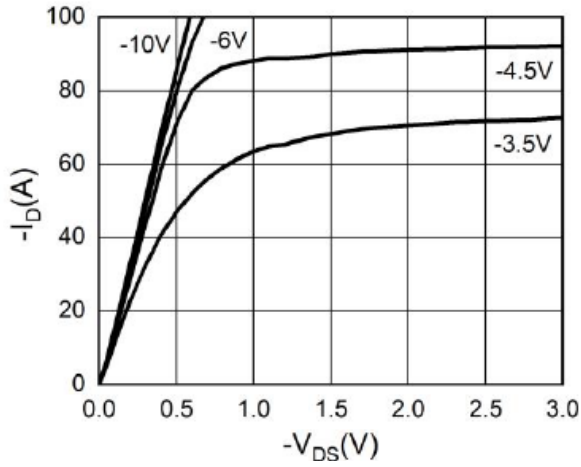

Fig.1 Output Characteristics

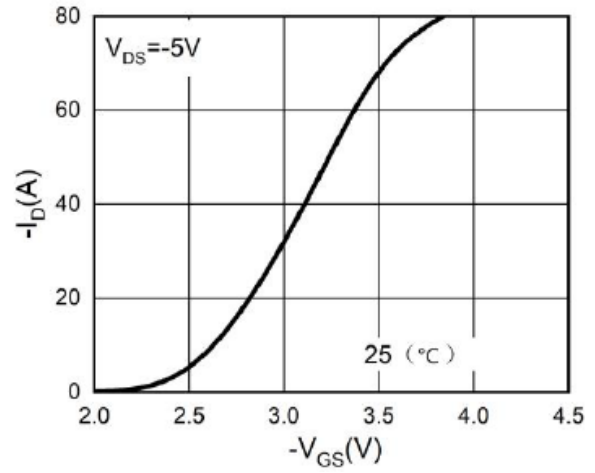

Fig.2 Transfer Characteristics

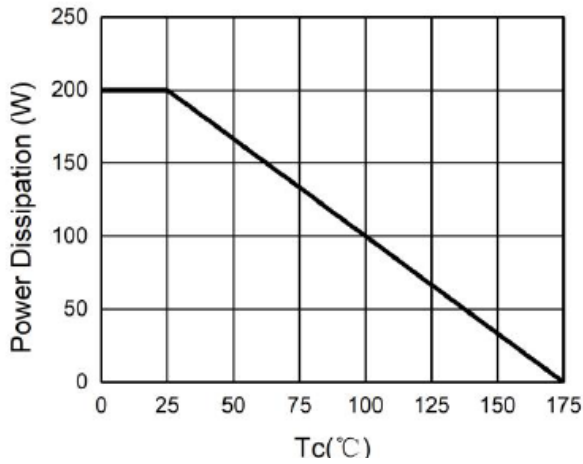

Fig.3 Power Dissipation

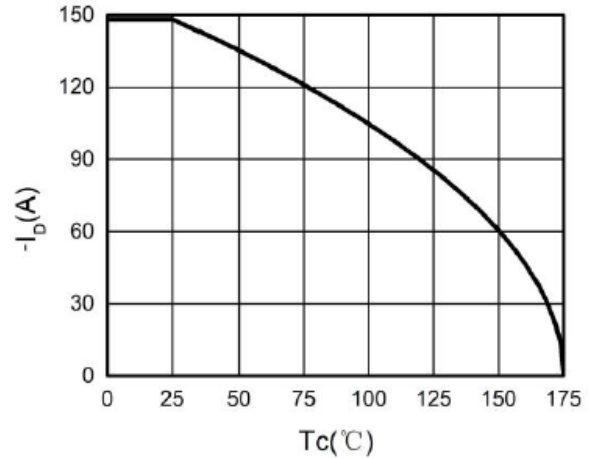

Fig.4 Drain Current

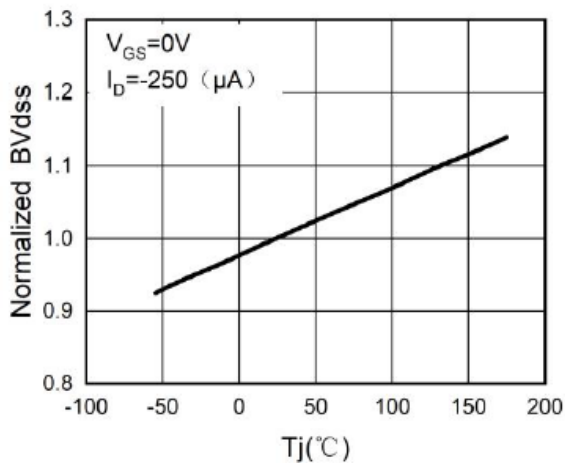

Fig.5  $BV_{dss}$  vs Junction Temperature

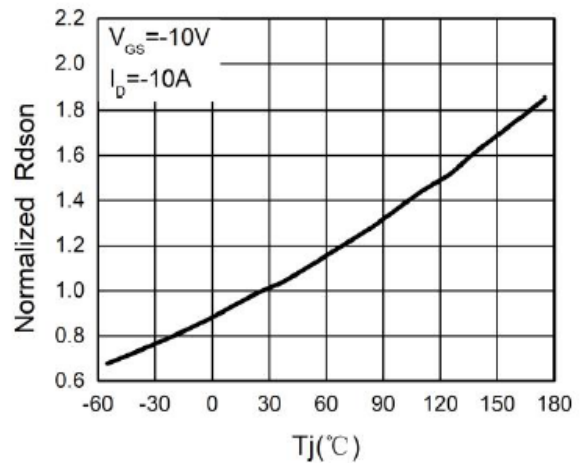

Fig.6  $R_{ds(on)}$  vs Junction Temperature

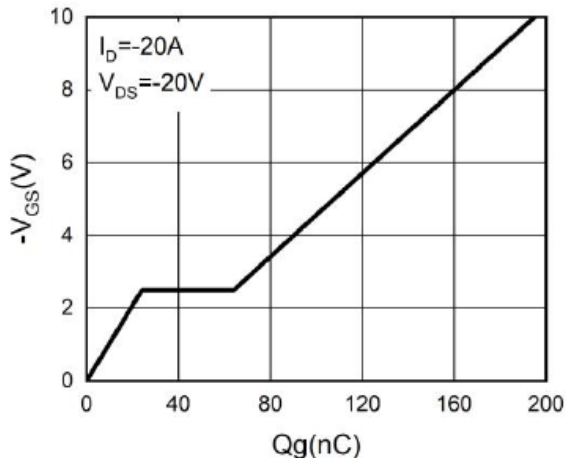

Fig.7 Gate Charge Waveforms

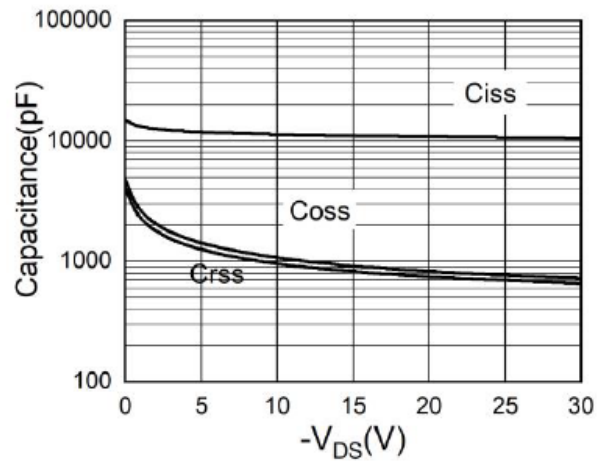

Fig.8 Capacitance

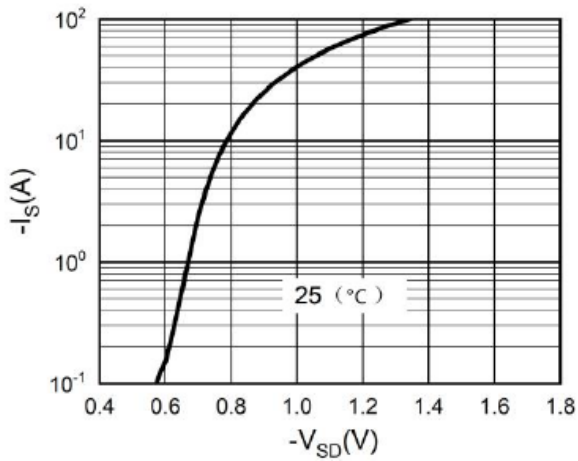

Fig.9 Body-Diode Characteristics

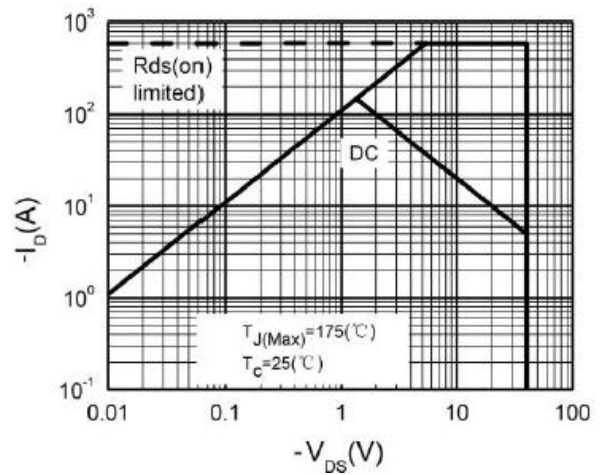
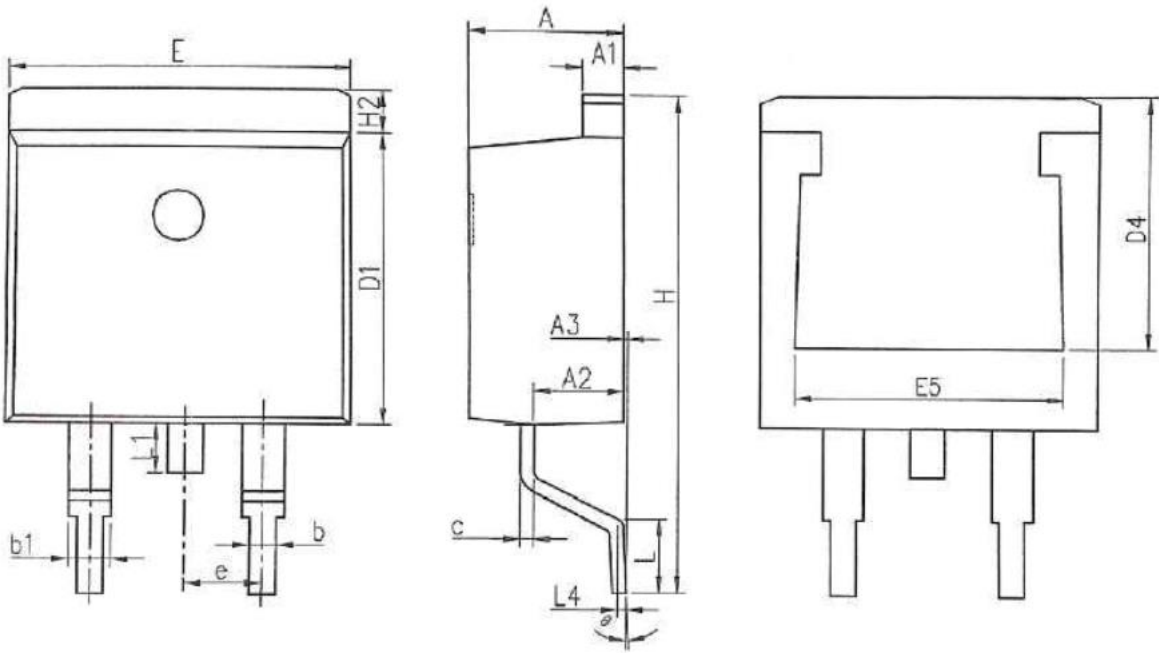

Fig.10 Maximum Safe Operating Area



SYMBOLS	MILLIMETERS		INCHES	
	MIN	MAX	MIN	MAX
A	4.370	4.770	0.172	0.188
A1	1.220	1.420	0.048	0.056
A2	2.200	2.890	0.087	0.114
A3	0.000	0.250	0.000	0.010
b	0.700	0.960	0.028	0.038
b1	1.170	1.470	0.046	0.058
c	0.300	0.530	0.012	0.021
D1	8.500	9.300	0.335	0.366
D4	6.600	-	0.260	-
E	9.860	10.36	0.388	0.408
E5	7.060	-	0.278	-
e	2.540 BSC		0.100 BSC	
H	14.70	15.70	0.579	0.618
H2	1.070	1.470	0.042	0.058
L	2.000	2.600	0.079	0.102
L1	1.400	1.750	0.055	0.069
L4	0.250 BSC		0.010 BSC	
Θ	0°	9°	0°	9°